



FM 1-02 (FM 101-5-1)
MCRP 5-12A

**OPERATIONAL TERMS
AND GRAPHICS**

SEPTEMBER 2004

DISTRIBUTION RESTRICTION:
Approved for public release; distribution is unlimited.

**HEADQUARTERS
DEPARTMENT OF THE ARMY**

**This publication is available at Army Knowledge
Online (www.us.army.mil) and the General Dennis J.
Reimer Training and Doctrine Digital Library at
(<http://www.train.army.mil>)**

***FM 1-02 (FM 101-5-1)**
MCRP 5-12A

Field Manual
No. FM 1-02 (FM 101-5-1)

Headquarters
Department of the Army
Washington, DC

MCRP 5-12A

Headquarters
Marine Corps Combat Development Command
Department of the Navy
Headquarters, United States Marine Corps
Washington, DC

21 September 2004

Operational Terms and Graphics

Contents

	Page
	PREFACE..... vi
	INTRODUCTION vii
Chapter 1	OPERATIONAL TERMS..... 1-1
Chapter 2	OPERATIONAL ACRONYMS, ABBREVIATIONS, AND COUNTRY CODES 2-1
	Section I – Acronyms and Abbreviations 2-1
	Section II – Two-Letter Geographical Entity Codes 2-31
Chapter 3	MULTI-SERVICE BREVITY CODES, PROCEDURE WORDS, AND TACTICAL TASKS 3-1
	Section I – Brevity Codes 3-1
	Section II – Procedure Words (Prowords) 3-25
	Section III – Tactical Mission Tasks 3-25
Chapter 4	MILITARY SYMBOLS 4-1
	Purpose 4-1
	Orientation of Military Symbols..... 4-2
	Composition of Military Symbols 4-2
	Basic Rules for Building Symbols..... 4-10
Chapter 5	UNIT SYMBOLS 5-1
	Composition of Unit Symbols 5-1
	Unit Symbol Modifier Fields..... 5-3
	Locating Unit Symbols..... 5-41

Distribution Restriction: Approved for public release; distribution is unlimited.

*This publication supersedes FM 101-5-1/MCRP 5-12A, 30 September 1997.

Chapter 6	EQUIPMENT SYMBOLS	6-1
	Orientation of Equipment Symbols	6-1
	Composition of Equipment Symbols.....	6-1
	Building Equipment Symbols	6-2
	Size and Range Indicators.....	6-30
Chapter 7	GRAPHIC CONTROL MEASURES	7-1
	Overlays	7-1
	Colors.....	7-1
	Orientation of Control Measures	7-2
	Building Graphic Control Measures	7-2
	Fire Support Coordinating Measures.....	7-9
	Targets	7-10
	Nuclear, Biological, and Chemical Attacks/Events	7-10
Chapter 8	INSTALLATION SYMBOLS	8-1
	Composition of Installation Symbols.....	8-1
	Installation Symbol Modifier Fields	8-2
Chapter 9	STABILITY OPERATIONS AND SUPPORT OPERATIONS SYMBOLS	9-1
	Composition of Stability Operations and Support Operations Symbols.....	9-1
	Stability Operations and Support Operations Symbol Modifier Fields.....	9-2
Appendix A	TACTICAL MISSION GRAPHICS	A-1
Appendix B	EXAMPLES OF MILITARY SYMBOLS	B-1
Appendix C	EXAMPLES OF THE USE OF MILITARY SYMBOLS	C-1
Appendix D	MILITARY DECISIONMAKING PROCESS GRAPHICS	D-1
	Status and Assessment Charts.....	D-1
	Combat Effectiveness Graphics.....	D-3
	Task Organization Composition Graphics	D-4
	Decision Graphics.....	D-7
	BIBLIOGRAPHY	Bibliography-1
	INDEX OF SYMBOLS	Index of Symbols-1

Figures

Figure 4-1. Components of a Military Symbol.....	4-2
Figure 4-2. Field Positions for Text or Graphic Modifiers	4-5
Figure 5-1. Unit Symbol Components.....	5-1
Figure 5-2. Unit Symbol Modifier Fields.....	5-3
Figure 5-3. Examples of Command Symbols	5-34
Figure 5-4. Examples of Task Forces	5-34
Figure 5-5. Examples of Reinforced, Reduced, and Reinforced and Reduced.....	5-35
Figure 5-6. Offset and Multiple Unit Locations.....	5-42
Figure 5-7. Offset Headquarters and Multiple Headquarters Locations	5-42
Figure 6-1. Equipment Symbol Components.....	6-1

Figure 6-2. Equipment Symbol Modifier Fields 6-4

Figure 7-1. Boundary Modifier Fields 7-2

Figure 7-2. Examples of Friendly Lateral Boundaries 7-3

Figure 7-3. Example of a Friendly Rear Boundary 7-4

Figure 7-4. Example of a Friendly Forward Boundary..... 7-4

Figure 7-5. Examples of Hostile Lateral Boundaries 7-4

Figure 7-6. Line Modifier Fields 7-6

Figure 7-7. Example of a Friendly Line of Departure on a Phase Line 7-6

Figure 7-8. Area Modifier Fields 7-7

Figure 7-9. Examples of Friendly Assembly Area and Pickup Zone 7-7

Figure 7-10. Point Modifier Fields..... 7-8

Figure 7-11. Examples of Friendly Ammunition Transfer Point and Class VIII Supply Point..... 7-9

Figure 7-12. Example of a Friendly FSCL on a Phase Line 7-10

Figure 7-13. Example of a Friendly No-Fire Area..... 7-10

Figure 7-14. Target Labeling Fields..... 7-10

Figure 7-15. Nuclear Attack/Event..... 7-11

Figure 7-16. Biological Event..... 7-11

Figure 7-17. Chemical Event 7-11

Figure 8-1. Installation Symbol Components 8-1

Figure 8-2. Installation Symbol Modifier Fields 8-3

Figure 9-1. Stability Operations and Support Operations Symbol Components..... 9-1

Figure 9-2. Stability Operations and Support Operations Symbol Modifier Fields..... 9-3

Figure A-1. Example of Decision Graphics and Tactical Mission Graphics A-7

Figure B-1. Airborne Infantry Divisions..... B-1

Figure B-2. Air Assault Infantry Divisions B-2

Figure B-3. Armored Divisions..... B-2

Figure B-4. Mechanized Infantry Divisions..... B-2

Figure B-5. Light Infantry Divisions..... B-3

Figure B-6. Infantry Divisions B-3

Figure B-7. Marine Divisions B-3

Figure B-8. Stryker Brigade Combat Teams B-4

Figure B-9. Supply Sites..... B-4

Figure B-10. Combat Service Support Units B-5

Figure B-11. Unit Symbols with Labeling Fields..... B-6

Figure B-12. Equipment Symbols with Labeling Fields..... B-7

Figure B-13. Installation Symbols with Labeling Fields..... B-8

Figure B-14. Stability Operations and Support Operations Symbols with Labeling Fields B-8

Figure C-1. Contiguous Areas of Operations C-1

Figure C-2. Noncontiguous Areas of Operations C-2

Figure C-3. Stability Operations and Support Operations..... C-2

Figure C-4. Combat Service Support Operations..... C-3

Figure D-1. Example of Bar Type Status Chart..... D-2

Figure D-2. Example of a Gumball Status Chart..... D-3
 Figure D-3. Example of Combat Effectiveness Chart D-4
 Figure D-4. Unit Symbol for Task Force 2-2 D-5
 Figure D-5. Example of a Task Organization Composition Graphic..... D-5
 Figure D-6. Example of a Company Team Decision Graphic..... D-8
 Figure D-7. Example of a Task Force Decision Graphic D-8
 Figure D-8. Example of a Brigade Decision Graphic D-9

Tables

Table 1-1. Seven Levels of MOPP..... 1-127
 Table 4-1. Frame Shapes for All Affiliations and Dimensions..... 4-3
 Table 4-2. Status of Symbols 4-4
 Table 4-3. Color Defaults 4-4
 Table 4-4. Descriptions of Fields for Text or Graphic Modifiers for Military Symbols 4-6
 Table 5-1. Building Unit Symbols..... 5-2
 Table 5-2. Descriptions of Fields for Text or Graphic Modifiers for Unit Symbols 5-4
 Table 5-3. Field A: Branch and Functional Symbols..... 5-6
 Table 5-4. Field A: Mobility and Capability Modifiers..... 5-26
 Table 5-5. Field A: Special Operations Forces 5-30
 Table 5-6. Field B: Echelon..... 5-33
 Table 5-7. Field AA: Named Command and Control Headquarters 5-36
 Table 5-8. Field AJ: Headquarters Element..... 5-39
 Table 5-9. Multifunctional Combat Service Support Units 5-40
 Table 6-1. Building Equipment Symbols with Frames 6-2
 Table 6-2. Building Equipment Symbols Without Frames 6-3
 Table 6-3. Descriptions of Fields for Text or Graphic Modifiers for Equipment Symbols 6-4
 Table 6-4. Field A: Equipment Types..... 6-7
 Table 6-5. Field R: Mobility Indicator 6-29
 Table 6-6. Standards for Size and Range Indicators by Equipment Systems..... 6-31
 Table 7-1. Description of Fields for Text or Graphic Modifiers for Boundaries..... 7-3
 Table 7-2. Unit Abbreviations..... 7-5
 Table 7-3. Description of Fields for Text or Graphic Modifiers for Lines 7-6
 Table 7-4. Description of Fields for Text or Graphic Modifiers for Areas..... 7-7
 Table 7-5. Description of Fields for Text or Graphic Modifiers for Points 7-9
 Table 7-6. Description of Fields for Text or Graphic Modifiers for Nuclear, Biological, and
 Chemical Attacks/Events..... 7-11
 Table 7-7. Examples of Maneuver Control Measures 7-12
 Table 7-8. Examples of Airspace Control Measures 7-19
 Table 7-9. Examples of Deception Control Measures 7-23

Table 7-10. Examples of Offensive Control Measures..... 7-28

Table 7-11. Examples of Special Maneuver Control Measures 7-33

Table 7-12. Examples of Fire Support Coordinating Measures 7-36

Table 7-13. Examples of Command and Control Measures 7-41

Table 7-14. Examples of Mobility/Counter mobility/Survivability Control Measures 7-45

Table 7-15. Examples of Survivability Control Measures..... 7-55

Table 7-16. Examples of Nuclear, Biological, and Chemical Control Measures..... 7-56

Table 7-17. Examples of Combat Service Support Control Measures..... 7-62

Table 8-1. Building Installation Symbols 8-2

Table 8-2. Graphic Modifiers for Installation Symbols..... 8-3

Table 8-3. Field A: Installation Function 8-6

Table 9-1. Building Stability Operations and Support Operations Symbols..... 9-2

Table 9-2. Descriptions of Fields for Text or Graphic Modifiers for Stability Operations and Support Operations Symbols..... 9-3

Table 9-3. Field AA: Stability Operations and Support Operations Activities, Locations, and Nonmilitary Organizations..... 9-6

Table A-1. Examples of Tactical Mission Graphics A-2

Preface

This manual is a dual-Service US Army and US Marine Corps publication introducing new terms and definitions and updating existing definitions as reflected in the latest editions of Army field manuals and Marine Corps doctrinal, warfighting, and reference publications. It complies with DOD Military Standard 2525. When communicating instructions to subordinate units, commanders and staffs from company through corps should use this manual as a dictionary of operational terms and military graphics.

This manual incorporates changes in joint terminology and definitions as reflected in JP 1-02 (as amended through June 2003) and provides a single standard for developing and depicting hand-drawn and computer-generated military symbols for situation maps, overlays, and annotated aerial photographs for all types of military operations. The symbology chapters of this manual focus primarily on land military symbols applicable for the Army and Marine Corps. In addition to terminology, this manual includes the following updated lists:

- Approved acronyms and abbreviations with their expansions.
- Two-letter country codes.
- Brevity codes and their meanings.
- Procedural words.
- Tactical tasks.

This manual applies to the Active Army, the US Army Reserves, the Army National Guard and the US Marine Corps.

This manual implements the following international agreements:

- STANAG 3680/AAP-6 (2003), *NATO Glossary of Terms and Definitions*.
- AAP-15, *NATO Glossary of Abbreviations Used in NATO Documents and Publications*.
- STANAG 1059, *National Distinguishing Letters for Use by NATO Armed Forces*, where appropriate for Army- and/or Marine Corps-specific usage.
- STANAG 2019/APP-6A, *Military Symbols For Land Based Systems*.
- QSTAG 509, *Military Symbols*.
- STANAG 2022, *Intelligence Reports*, for the evaluation ratings in annex A.
- STANAG 2961, *Classes of Supply of NATO Land Forces*, for reference and comparison with US classes of supply.

The proponent for this manual is Headquarters, US Army Training and Doctrine Command. Send written comments and recommendations on DA Form 2028 (*Recommended Changes to Publications and Blank Forms*) directly to Commander, US Army Combined Arms Center and Fort Leavenworth, ATTN: ATZL-CD (FM 1-02), 1 Reynolds Avenue (Building 111), Fort Leavenworth, KS 66027-1352. Send comments and recommendations by e-mail to web-cadd@leavenworth.army.mil. Follow the DA Form 2028 format or submit an electronic DA Form 2028.

Unless stated otherwise, masculine nouns or pronouns do not refer exclusively to men.

Introduction

The terminology section of this manual is a compilation of doctrinally-accepted definitions that have been taken from approved manuals. One Army field manual is cited as the proponent or reference for each definition. (NOTE: As the US Army is in the process of changing the numbering system for its field manuals, the cited manual number reflects the number that was in effect at the time FM 1-02 was approved.) The proponent manual for all Marine Corps definitions in this publication is MCRP 5-12C, *Marine Corps Supplement to the Department of Defense Dictionary of Military and Associated Terms*.

Terminology entries in this manual fall into the following five categories:

- Definitions that are applicable to the US Army only. The definition is preceded by “(Army)” and followed by the proponent US Army field manual in parentheses:

situational understanding – (Army) The product of applying analysis and judgment to the common operational picture to determine the relationship among the factors of METT-TC. (FM 3-0)

- Definitions that are applicable to the US Marine Corps only. The definition is preceded by “(Marine Corps)”:

situational awareness – (Marine Corps) Knowledge and understanding of the current situation which promotes timely, relevant, and accurate assessment of friendly, enemy, and other operations within the battlespace in order to facilitate decisionmaking. An informational perspective and skill that fosters an ability to determine quickly the context and relevance of events that are unfolding.

- Definitions that are applicable to both the US Army and US Marine Corps. The definition follows the term directly, and the proponent Army manual follows the definition:

actions on contact – A series of combat actions, often conducted simultaneously, taken upon contact with the enemy to develop the situation. (FM 3-90)

In some cases the Army and Marine Corps have agreed on a compromise definition for a particular term. This definition does not appear in either Service’s manuals, but will be incorporated into them when the appropriate manuals are revised. In such cases the definition is preceded by “(Army/Marine Corps)” and followed by the proponent Army manual:

route reconnaissance – (Army/Marine Corps) A directed effort to obtain detailed information of a specified route and all terrain from which the enemy could influence movement along that route. (FM 3-90)

- Joint and/or NATO terms whose definitions are applicable to the Army and Marine Corps as well. Joint and NATO definitions are reproduced exactly as they appear in JP 1-02 (12 April 2001, as amended through 05 June 2003) and AAP-6 (2003) respectively. The definition is preceded by one of four possible parenthetical notations (see below). “See FM

XX” follows the definition, signifying that the indicated manual is the reference manual for Army-specific usage:

- (DOD): the term is a joint term.

persistent agent – (DOD) A chemical agent that, when released, remains able to cause casualties for more than 24 hours to several days or weeks. See FM 3-9.

- (NATO): the term is a NATO term.

reference box – (NATO) The identification box placed in the margin of a map or chart which contains the series designation, sheet number and edition number in a readily identifiable form. See FM 3-25.26.

- (DOD, NATO): the term is both a joint and NATO term, and the joint and NATO definitions are virtually the same (with minor differences noted).

combat power – (DOD, NATO) The total means of destructive and/or disruptive force which a military unit/formation can apply against the opponent at a given time. See FM 3-0.

state of readiness – state 2 - armed – (DOD, NATO) The state of a demolition target in which the demolition charges are in place, the firing and priming circuits are installed and complete, and the charge is ready for immediate firing. [Note: the NATO definition does not include “and the charge is.”] See FM 5-250.

- (DOD)... [Note: see AAP-6]: the term is both a joint and NATO term. The definitions are similar in meaning, but the wording is different. If the reader requires the exact NATO definition, he should consult AAP-6 (most current edition), *NATO Glossary of Terms and Definitions*.

immediate decontamination – (DOD) Decontamination carried out by individuals immediately upon becoming contaminated. It is performed in an effort to minimize casualties, save lives, and limit the spread of contamination. [Note: See AAP-6.] See FM 3-5.

- Joint/NATO terms that are used by the Army/Marine Corps, but whose definitions are either inadequate for or not applicable to specific Army/Marine Corps usage. Both the joint and NATO definitions and the Service definitions are given. Where Army and Marine Corps definitions differ from each other, both are provided. The Army definition is followed by the proponent manual.

seize – (DOD) To employ combat forces to occupy physically and control a designated area. (Army) A tactical mission task that involves taking possession of a designated area using overwhelming force. (FM 3-90) (Marine Corps) To clear a designated area and obtain control of it.

If the term is a joint/NATO term, but no Army field manual is referenced, then this indicates that the Marine Corps has pronency for the term and definition:

action phase - (DOD) In an amphibious operation, the period of time between the arrival of the landing forces of the amphibious force in the operational area and the accomplishment of their mission. See also **amphibious force**; **amphibious operation**; **landing force**; **mission**.

In addition, there are two further descriptors that may appear after a definition:

- “Also called”: If the term has an accepted abbreviation or acronym, the abbreviation or acronym appears bolded after the definition, preceded by “Also called”:

passage point – A specifically designated place where the passing units will pass through the stationary unit. Also called **PP**. (FM 3-90)

- “See also”: If there are any related terms defined elsewhere in the manual, they are cross-referenced at the end of the definition as bolded terms preceded by “See also”:

hostile criteria – Description of conditions under which an aircraft or a vehicle may be identified as hostile for engagement purposes. See also **hostile acts**; **rules of engagement**. (FM 27-10)

The symbology section is broken down into chapters dealing with unit symbols, equipment symbols, graphic control measures, installation symbols, and stability operations and support operations symbols. Each of these chapters provides detailed requirements for composing and constructing its associated symbols and control measures. While the manual does not include every possible symbol for every possible context, the rules for building a specific set of military symbols allow enough flexibility for users to create any symbol to meet their operational needs.

This manual contains a compilation of graphic control measures. This revision includes information on building symbols and using graphics omitted in the 1997 version that appeared in earlier versions of military symbology manuals. It includes a link between terms and symbols with the cross-referenced terms, including the proponent manual that provides the description for the usage of the graphic control measures. All graphic control measures in this manual are linked to doctrine.

Chapter 1

Operational Terms

—A—

abatis – A vehicular obstacle constructed by felling trees (leaving a 1- to 2-meter stump above the ground on both sides of a road, trail, gap, or defile) so that they fall, interlocked, toward the expected direction of enemy approach. The trees should remain attached to the stumps and be at a 45-degree angle to the roadway. The obstacle itself should be at least 75 meters in depth to be most effective. (FM 5-103) (See page 7-45 for symbol.)

abort criteria – A predetermined set of circumstances, based on risk assessment, which makes the success of an operation no longer probable; thus the operation is terminated. These circumstances can relate to changes in safety, equipment or troops available, preparation or rehearsal time, weather, enemy, losses during execution, or a combination of the above. See also **air assault operation**. (FM 3-05.20)

above ground level – The altitude of an aircraft as measured between the terrain (excluding vegetation and man-made structures) and the aircraft. The altitude is usually not the same as measured from sea level. Also called **AGL**. See also **coordinating altitude**. (FM 3-04.111)

absorbed dose – (DOD, NATO) The amount of energy imparted by nuclear (or ionizing) radiation to unit mass of absorbing material. [Note: DOD and NATO use rad as the unit, the Army uses centigray.] See also **centigray**; **dose rate**. See FM 3-3-1.

accessibility – The availability of an audience for targeting by psychological operations. (FM 3-05.30)

accident risk – All operational risk considerations other than tactical risks. Includes risk to friendly forces and risk posed to civilians by an operation, as well as the impact of operations on the environment. See also **tactical risk**. (FM 3-100.4)

accompanying supplies – (DOD) Unit supplies that deploy with forces. See also **basic load**; **combat load**. See FM 4-0.

accountability – (DOD) The obligation imposed by law or lawful order or regulation on an officer or other person for keeping accurate record of property, documents, or funds. The person having this obligation may or may not have actual possession of the property, documents, or funds. Accountability is concerned primarily with records, while responsibility is concerned primarily with custody, care, and safekeeping. (Army) The requirement for a commander to answer to superiors for mission accomplishment, for the lives and care of the soldiers under his command, and for the effective and efficient use of Army resources. (FM 6-0)

acknowledge – A directive from the originator of a communication requiring the addressee(s) to advise the originator that his communication has been received and understood. This term is

normally included in the electronic transmission of orders to ensure the receiving station or person confirms the receipt of the order. See also **acknowledgment**. (FM 11-32)

acknowledgment – (NATO) A message from the addressee informing the originator that his communication has been received and understood. See also **acknowledge**. See FM 11-32.

acoustic jamming – (DOD) The deliberate radiation or reradiation of mechanical or electroacoustic signals with the objectives of obliterating or obscuring signals that the enemy is attempting to receive and of disrupting enemy weapon systems. See FM 34-1.

acoustic surveillance – Employment of electronic devices, including sound-recording, receiving, or transmitting equipment, for the collection of information. (FM 34-1)

action phase – (DOD) In an amphibious operation, the period of time between the arrival of the landing forces of the amphibious force in the operational area and the accomplishment of their mission. See also **amphibious force**; **amphibious operation**; **landing force**; **mission**.

action program – A sequential, coordinated presentation of a series of actions to achieve a specific psychological operation objective. See also **psychological operations program**. (FM 3-05.30)

actions on contact – A series of combat actions, often conducted simultaneously, taken upon contact with the enemy to develop the situation. (FM 3-90)

active air defense – (DOD) Direct defensive action taken to destroy, nullify, or reduce the effectiveness of hostile air and missile threats against friendly forces and assets. It includes the use of aircraft, air defense weapons, electronic warfare, and other available weapons. [Note: See AAP-6.] See also **air defense**; **passive air defense**. See FM 44-100.

active defense – (DOD) The employment of limited offensive action and counterattacks to deny a contested area or position to the enemy. (Army) One of the four operational elements of theater missile defense. Operations that protect selected assets and forces from attack by destroying theater missile (TM) airborne launch platforms and/or TMs in flight. Active defense also includes those actions that mitigate the effectiveness of targeting and delivery systems through electronic warfare against remote or onboard guidance systems. See also **attack operations**; **passive defense**; **theater missile defense**. (FM 100-12)

active duty for training – (DOD) A tour of active duty which is used for training members of the Reserve Components to provide trained units and qualified persons to fill the needs of the Armed Forces in time of war or national emergency and such other times as the national security requires. The member is under orders which provide for return to nonactive status when the period of active duty for training is completed. This includes annual training, special tours of active duty for training, school tours, and the initial duty for training performed by nonprior service enlistees. Also called **ADT**.

acute-care services – Medical services provided for patients with conditions having a gradual to rapid onset that follows a short but acute course. The majority of medical care far forward is acute care service. The objective of acute care service is to treat symptomatic manifestations. (FM 4-02.24)

add – (NATO) In artillery and naval fire support, a correction used by an observer/spotter to indicate that an increase in range along the spotting line is desired. [Note: the Army definition also applies to mortar fire.] See FM 6-30.

adjust – (DOD) An order to the observer or spotter to initiate an adjustment on a designated target. See FM 6-30.

adjust fire – (NATO) In artillery and naval fire support: 1. A method of control transmitted in the call for fire by the observer or spotter to indicate that he will control the adjustment. 2. An order or request to initiate an adjustment of fire. See also **call for fire**. See FM 6-30.

adjustment decision – During preparation and execution, the selection of a course of action that modifies the order to respond to unanticipated opportunities or threats. (FM 6-0)

adjustment of fire – (NATO) Process used in artillery and naval gunfire to obtain correct bearing, range, and height of burst (if time fuzes are used) when engaging a target by observed fire. See also **call for fire**. See FM 6-30.

administrative control – (DOD) Direction or exercise of authority over subordinate or other organizations in respect to administration and support, including organization of Service forces, control of resources and equipment, personnel management, unit logistics, individual and unit training, readiness, mobilization, demobilization, discipline, and other matters not included in the operational missions of the subordinate or other organizations. (NATO) Direction or exercise of authority over subordinate or other organizations in respect to administrative matters such as personnel management, supply, services, and other matters not included in the operational missions of the subordinate or other organizations. Also called **ADCON**. See also **command relationships**. See FM 3-0.

administrative landing – (DOD) An unopposed landing involving debarkation from vessels that have been administratively loaded. See also **administrative movement; logistics over-the-shore operations**.

administrative movement – (DOD, NATO) A movement in which troops and vehicles are arranged to expedite their movement and conserve time and energy when no enemy interference, except by air, is anticipated. See also **administrative landing**. See FM 3-0.

admission rates – The number of patients admitted to inpatient setting within a hospital from a specified population over a designated period of time. (FM 8-55)

advanced operations base – (DOD) In special operations, a small temporary base established near or within a joint special operations area to command, control, and/or support training or tactical operations. Facilities are normally austere. The base may be ashore or afloat. If ashore, it may include an airfield or unimproved airstrip, a pier, or an anchorage. An advanced operations base is normally controlled and/or supported by a main operations base or a forward operations base. [Note: the Army SOF term is “advanced operational base.”] Also called **AOB**. See also **forward operations base; main operations base**. See FM 100-25.

advance guard – (DOD) Detachment sent ahead of the main force to ensure its uninterrupted advance; to protect the main body against surprise; to facilitate the advance by removing obstacles and repairing roads and bridges; and to cover the deployment of the main body if it is committed to action. See also **exploitation; movement to contact; pursuit; reconnaissance in force**. See FM 3-90.

advance party – A team that coordinates the convoy’s arrival at the destination. It may move with the main body initially but must arrive at the destination sufficiently ahead of the main body. See also **march column**; **quartering party**. (FM 4-01.30).

advance to contact – (NATO) An offensive operation designed to gain or re-establish contact with the enemy. [Note: DOD uses the term “movement to contact” instead.] See also **meeting engagement**; **offensive operations**; **reconnaissance in force**. See FM 3-0.

advance trauma life support – Resuscitative and stabilizing medical or surgical treatment provided to patients to save life or limb and to prepare them for further evacuation without jeopardizing their well-being or prolonging the state of their condition. Also called **ATLS**. (FM 4-02.6)

aerial port– (DOD) An airfield that has been designated for the sustained air movement of personnel and materiel, as well as an authorized port for entrance into or departure from the country where located. Also called **APORT**. See FM 100-17.

aerial port of debarkation – An airfield for sustained air movement at which personnel and materiel are discharged from aircraft. Aerial ports of debarkation normally serve as ports of embarkation for return passengers and retrograde cargo shipments. Also called **APOD**. (FM 55-1) (See page 5-25 for symbol.)

aerial port of embarkation – An airfield for sustained air movement at which personnel and materiel board or are loaded aboard aircraft to initiate aerial movement. Aerial ports of embarkation may serve as ports of debarkation for return passengers and retrograde cargo shipments. Also called **APOE**. (FM 55-1) (See page 5-25 for symbol.)

aeromedical evacuation – (DOD, NATO) The movement of patients under medical supervision to and between medical treatment facilities by air transportation. [Note: the NATO definition does not include “under medical supervision.”] Also called **AE**. See FM 8-10-6.

aeromedical staging facility – A United States Air Force staging facility employed at or near airfields in the combat zone and echelons above corps. It also provides a temporary staging capability for patients being evacuated from echelons above corps or another theater to the continental United States. The facility is employed to ensure patients are prepared for aircraft loading with the main focus of reducing aeromedical evacuation aircraft ground time. Also called **ASF**. (FM 8-10-6)

agents of action – Persons and organizations who carry out programs of psychological actions. Discretionary agents are persons or organizations whose activities are planned primarily for their psychological impact. Incidental agents are persons or organizations whose activities generate a psychological impact secondary to the military operation. (FM 3-05.30)

agility – The ability to move and adjust quickly and easily. (FM 3-0)

agreed point – (NATO) A predetermined point on the ground, identifiable from the air, and used when aircraft assist in fire adjustment. See FM 6-30.

aid station – The first medical treatment facility that can provide advanced trauma management to a battlefield casualty. It provides first level of triage evaluation of casualties and conducts routine sick call. See also **level of care**. (FM 4-02)

air – (DOD, NATO) In artillery and naval gunfire support, a spotting, or an observation, by a spotter or an observer to indicate that a burst or group of bursts occurred before impact. [Note: the Army definition also applies to mortar fire.] See also **adjustment of fire**. See FM 6-30.

air assault operation – (DOD) Operation in which assault forces (combat, combat service, and combat service support), using the firepower, mobility, and total integration of helicopter assets, maneuver on the battlefield under the control of the ground or air maneuver commander to engage and destroy enemy forces or to seize and hold key terrain. See also **abort criteria; airhead; air mission brief; air mission commander**. See FM 90-4.

airborne – (DOD) 1. In relation to personnel, troops especially trained to effect, following transport by air, an assault debarkation, either by parachuting or touchdown. 2. In relation to equipment, pieces of equipment that have been especially designed for use by airborne troops during or after an assault debarkation. It also designates some aeronautical equipment used to accomplish a particular mission. 3. When applied to materiel, items that form an integral part of the aircraft. 4. The state of an aircraft from the instant it becomes entirely sustained by air until it ceases to be so sustained. A lighter-than-air aircraft is not considered to be airborne when it is attached to the ground, except that moored balloons are airborne whenever sent aloft. See FM 3-90. (See page 5-26 for symbol.)

airborne force – (DOD, NATO) A force composed primarily of ground and air units organized, equipped, and trained for airborne operations. See FM 3-90.

airborne operation – (DOD) An operation involving the air movement into an objective area of combat forces and their logistic support for execution of a tactical, operational, or strategic mission. The means employed may be any combination of airborne units, air transportable units, and types of transport aircraft, depending on the mission and the overall situation. See FM 3-90.

airburst – (DOD, NATO) An explosion of a bomb or projectile above the surface as distinguished from an explosion on contact with the surface or after penetration. See FM 6-30.

air contingency Marine air-ground task force – An on-call, combat-ready Marine air-ground task force (MAGTF) that deploys by airlift. Air contingency MAGTFs vary in size based on mission requirements and the availability of airlift. Because they deploy by air, they generally have a limited organic logistic capability, and require an arrival airfield. Air contingency MAGTFs usually are activated to respond to developing crises, and may deploy independently or in conjunction with other expeditionary forces. Also called **ACM**. See also **aviation combat element; combat service support element; ground combat element; Marine air-ground task force; Marine expeditionary force; Marine expeditionary force (forward); Marine expeditionary unit; special purpose Marine air-ground task force; task force**.

air controller – (NATO) An individual especially trained for and assigned the duty of the control (by use of radio, radar, or other means) of such aircraft as may be allotted to him for operation within his area. See FM 3-04.111.

air control point – An easily identifiable point on the terrain or an electronic navigational aid used to provide necessary control during air movement. Air control points are generally designated at each point where the flight route or air corridor makes a definite change in any direction and at any other point deemed necessary for timing or control of the operation. Also

called **ACP**. See also **air corridor**; **communications checkpoint**; **minimum-risk route**. (FM 3-52) (See page 7-22 for symbol.)

air corridor – (DOD, NATO) A restricted air route of travel specified for use by friendly aircraft and established for the purpose of preventing friendly aircraft from being fired on by friendly forces. Also called **flight corridor**. See also **air control point**. See FM 3-52. (See page 7-19 for symbol.)

air defense – (DOD) All defensive measures designed to destroy attacking enemy aircraft or missiles in the Earth's envelope of atmosphere, or to nullify or reduce the effectiveness of such attack. Also called **AD**. See also **active air defense**; **passive air defense**. See FM 4-100. (See page 5-6 for symbol.)

air defense battlefield operating system – (Army) Protects the force from missile attack, air attack, and aerial surveillance by any of the following: ballistic missiles, cruise missiles, conventional fixed- and rotary-wing aircraft, and unmanned aerial vehicles. It prevents enemies from interdicting friendly forces, while freeing commanders to synchronize movement and firepower. See also **battlefield operating system**. (FM 7-15)

air defense warning conditions – (DOD) A degree of air raid probability according to the following code. The term "air defense division/sector" referred to herein may include forces and units afloat and/or deployed to forward areas, as applicable. **a. Air defense warning yellow**—attack by hostile aircraft and/or missiles is probable. This means that hostile aircraft and/or missiles are en route toward an air defense division/sector, or unknown aircraft and/or missiles suspected to be hostile are en route toward or are within an air defense division/sector. **b. Air defense warning red**—attack by hostile aircraft and/or missiles is imminent or in progress. This means that hostile aircraft and/or missiles are within an air defense division/sector or are in the immediate vicinity of an air defense division/sector with high probability of entering the division/sector. **c. Air defense warning white**—attack by hostile aircraft and/or missiles is improbable. May be called either before or after air defense warning yellow or red. The initial declaration of air defense emergency will automatically establish a condition of air defense warning other than white for purposes of security control of air traffic. See FM 44-100.

air defense weapon control status – The degree of fire control imposed upon Army units having assigned, attached, or organic air defense weapons. Weapons control status terms are: **a. Weapons free**—a weapon control order imposing a status whereby weapons systems may be fired at any target not positively recognized as friendly. **b. Weapons hold**—a weapon control order imposing a status whereby weapons systems may only be fired in self-defense or in response to a formal order. **c. Weapons tight**—a weapon control order imposing a status whereby weapons systems may be fired only at targets recognized as hostile. (FM 44-100)

airdrop – (DOD) The unloading of personnel or materiel from aircraft in flight. See also **air movement**. See FM 100-17.

airhead – (DOD, NATO) 1. A designated area in a hostile or threatened territory which, when seized and held, ensures the continuous air landing of troops and materiel and provides the maneuver space necessary for projected operations. Normally it is the area seized in the assault phase of an airborne operation. 2. A designated location in an area of operations used as a base for supply and evacuation by air. See also **air assault operation**; **airborne operation**. See FM 90-26. (See page 7-34 for symbol.)

- airhead line** – (DOD) A line denoting the limits of the objective area for an airborne assault. The airhead line is bounded by assault objectives that are operationally located to ensure that enemy fires cannot be brought to bear on the main objective and for friendly forces to conduct defensive operations in depth. See also **air assault operation; airborne operation**. See FM 3-90. (See page 7-34 for symbol.)
- air interdiction** – (DOD, NATO) Air operations conducted to destroy, neutralize, or delay the enemy's military potential before it can be brought to bear effectively against friendly forces at such distance from friendly forces that detailed integration of each air mission with the fire and movement of friendly forces is not required. Also called **AI**. See FM 3-04.111.
- air landed** – (DOD, NATO) Moved by air and disembarked or unloaded after the aircraft has landed or while a helicopter is hovering. See also **air assault operation; airborne operation**. See FM 90-26.
- air liaison officer** – (DOD) An officer (aviator/pilot or naval flight officer) attached to a ground unit who functions as the primary advisor to the ground commander on air operation matters. Also called **ALO**. See also **tactical air control party**. See FM 3-04.111.
- air mission brief** – 1. The last coordination meeting of key participants in an air assault operation which ensures that key aviation soldiers are briefed and that the plan is finalized. It covers the operation from beginning to end. 2. Briefing of the pilots prior to any aviation mission. Also called **AMB**. See also **abort criteria; air assault operation; airhead; air mission commander**. (FM 3-04.111)
- air mission commander** – (Army) Commander of the largest aviation unit supporting the air assault operation. He is responsible for all embarked soldiers and for coordinating all support from liftoff to touchdown. (FM 3-04.111) (Marine Corps) A mission commander, who shall be a properly qualified naval aviator or naval flight officer, should be designated when separate aircraft formations, each led by its own formation leader, are required for a common support mission or whenever a formation of four or more aircraft must perform a multiple sortie mission. The mission commander shall direct a coordinated plan of action and shall be responsible for the effectiveness of the mission. Also called **AMC**. See also **abort criteria; air assault operation; air mission brief**.
- air movement** – (DOD, NATO) Air transport of aircraft, units, personnel, supplies, and equipment, including airdrops and air landings. See also **aerial port of embarkation; aerial port of debarkation; airdrop; air landed; tanker airlift control element**. See FM 55-1.
- air parity** – The functional equivalency between enemy and friendly air forces in strength and capability to attack and destroy targets. (FM 3-04.111)
- air reconnaissance** – (DOD) The acquisition of information by employing visual observation and/or sensors in air vehicles. See also **reconnaissance**. See FM 34-1.
- airspace control area** – (DOD) Airspace that is laterally defined by the boundaries of the operational area. The airspace control area may be subdivided into airspace control sectors. See FM 3-52.
- airspace control authority** – (DOD, NATO) The commander designated to assume overall responsibility for the operation of the airspace control system in the airspace control area. Also called **ACA**. See also **airspace control area**. See FM 3-52.

- airspace control in the combat zone** – (DOD) A process used to increase combat effectiveness by promoting the safe, efficient, and flexible use of airspace. Airspace control is provided in order to prevent fratricide, enhance air defense operations, and permit greater flexibility of operations. Airspace control does not infringe on the authority vested in commanders to approve, disapprove, or deny combat operations. Also called **airspace control** and **combat airspace control**. See also **airspace control authority**; **airspace control order**; **airspace coordination area**. See FM 3-52.
- airspace control measures** – Rules, mechanisms, and directions governed by joint doctrine and defined by the airspace control plan which control the use of airspace of specified dimensions. See also **high-density airspace control zone**; **low-level transit route**; **minimum-risk route**; **standard use Army aircraft flight route**. (FM 3-52) (See page 7-19 for symbol.)
- airspace control order** – (DOD) An order implementing the airspace control plan that provides the details of the approved requests for airspace control measures. It is published either as part of the air tasking order or as a separate document. Also called **ACO**. See FM 3-52.
- airspace coordination area** – (DOD) A three-dimensional block of airspace in a target area, established by the appropriate ground commander, in which friendly aircraft are reasonably safe from friendly surface fires. The airspace coordination area may be formal or informal. Also called **ACA**. See also **Army airspace command and control**. See FM 3-52. (See page 7-37 for symbol.)
- air strike** – (DOD) An attack on specific objectives by fighter, bomber, or attack aircraft on an offensive mission. May consist of several air organizations under a single command in the air. See FM 3-04.111.
- air superiority** – (DOD, NATO) That degree of dominance in the air battle of one force over another which permits the conduct of operations by the former and its related land, sea, and air forces at a given time and place without prohibitive interference by the opposing force. See FM 3-04.111.
- air support operations center** – (DOD, NATO) An agency of a tactical air control system collocated with a corps headquarters or an appropriate land force headquarters, which coordinates and directs close air support and other tactical air support. Also called **ASOC**. See FM 3-52.
- air supremacy** – (DOD, NATO) That degree of air superiority wherein the opposing air force is incapable of effective interference. See FM 3-04.111.
- air surveillance** – (DOD) The systematic observation of airspace by electronic, visual, or other means, primarily for the purpose of identifying and determining the movements of aircraft and missiles, friendly and enemy, in the airspace under observation. See FM 34-1.
- air terminal** – (DOD) A facility on an airfield that functions as an air transportation hub and accommodates the loading and unloading of airlift aircraft and the in-transit processing of traffic. The airfield may or may not be designated an aerial port. See FM 55-60.
- all after** – A procedure word meaning, “The portion of the message to which I have reference is all that follows (insert text).” See also **procedure word**. (FM 24-19)

all before – A procedure word meaning, “The portion of the message to which I have reference is all that precedes (insert text).” See also **procedure word**. (FM 24-19)

alliance – (DOD) The result of formal agreements (i.e., treaties) between two or more nations for broad, long-term objectives that further the common interests of the members. See also **coalition; multinational operations**. See FM 100-8.

allocated forces and resources – Those forces provided by the President and the Secretary of Defense or their duly deputized alternates or successors for execution planning or actual implementation. (FM 3-0)

allocation – (DOD) In a general sense, distribution of limited resources among competing requirements for employment. Specific allocations (e.g., air sorties, nuclear weapons, forces, and transportation) are described as allocation of air sorties, nuclear weapons, etc. See also **apportionment**. See FM 100-12.

allowable load – (DOD, NATO) The total load that an aircraft can transport over a given distance, taking into account weight and volume. See FM 100-17.

all-source intelligence – (DOD) 1. Intelligence products and/or organizations and activities that incorporate all sources of information, most frequently including human resources intelligence, imagery intelligence, measurement and signature intelligence, signals intelligence, and open-source data in the production of finished intelligence. 2. In intelligence collection, a phrase that indicates that in the satisfaction of intelligence requirements, all collection, processing, exploitation, and reporting systems and resources are identified for possible use and those most capable are tasked. (Army) – Intelligence that is produced through the analysis of all available information obtained through intelligence, surveillance, and reconnaissance (ISR) operations. (FM 34-1)

alternate command post – (DOD) Any location designated by a commander to assume command post functions in the event the command post becomes inoperative. It may be partially or fully equipped and manned or it may be the command post of a subordinate unit. See also **combat trains command post; command post; tactical operations center**.

alternate position – A defensive position that the commander assigns to a unit or weapon for occupation when the primary position becomes untenable or unsuitable for carrying out the assigned task. See also **primary position; successive positions; supplementary position**. (FM 3-90)

alternate supply route – A route or routes designated within an area of operations to provide for the movement of traffic when main supply routes become disabled or congested. Also called **ASR**. See also **main supply route**. (FM 4-0) (See page 7-69 for symbol.)

ambulance control point – Consists of a soldier (from the ambulance company or platoon) stationed at a crossroad or road junction where ambulances may take one of two or more directions to reach loading points. The soldier, knowing from which location each loaded ambulance has come, directs empty ambulances returning from the rear. The need for control points is dictated by the tactical situation. Generally, they are more necessary in the forward area. (FM 4-02.6)

ambulance exchange point – (DOD) A location where a patient is transferred from one ambulance to another en route to a medical treatment facility. This may be an established

point in an ambulance shuttle system or it may be designated independently. Also called **AXP**. See FM 4-02.6. (See page 7-62 for symbol.)

ambulance shuttle system – An effective and flexible method of employing ambulances during combat. It consists of one or more ambulance loading points, relay points, and, when necessary, ambulance control points, all echeloned forward from the principal group of ambulances, the company location, or basic relay points as tactically required. (When patients are being transported by litter carriers, this system is referred to as a litter shuttle system). (FM 4-02.6)

ambush – (Army) A form of attack by fire or other destructive means from concealed positions on a moving or temporarily halted enemy. (FM 3-0) (Marine Corps) A surprise attack by fire from concealed positions on a moving or temporarily halted enemy. (See page 7-33 for symbol.)

ammunition supply point – An area designated to receive, store, reconfigure, and issue Class V material. It is normally located at or near the division area. Also called **ASP**. See also **classes of supply**. (FM 9-6) (See page 7-68 for symbol.)

ammunition transfer point – A designated temporary site from which Class V material is transferred from corps transportation to unit vehicles. Also called **ATP**. See also **classes of supply**. (FM 4-0) (See page 7-68 for symbol.)

amphibious force – (DOD, NATO) An amphibious task force and a landing force, together with other forces that are trained, organized and equipped for amphibious operations. [Note: the NATO definition replaces “amphibious task force” with “naval force” and “other forces” with “supporting force.”] (NATO only) In naval usage, the administrative title of the amphibious type command of a fleet. Also called **AF**. See also **amphibious operation; amphibious task force; landing force**.

amphibious operation – (DOD) A military operation launched from the sea by an amphibious force, embarked in ships or craft with the primary purpose of introducing a landing force ashore to accomplish the assigned mission. See also **action phase; amphibious force; amphibious task force; embarkation phase; landing force; mission; movement phase; operation; planning phase; rehearsal phase**.

amphibious task force – (DOD) A Navy task organization formed to conduct amphibious operations. The amphibious task force, together with the landing force and other forces, constitutes the amphibious force. See also **amphibious force; amphibious operation; landing force**.

analysis (intelligence) – The process by which collected information is evaluated and integrated with existing information to produce intelligence that describes the current, and predicts the future, impact of the threat and/or environment on operations. (FM 34-3)

analysis and control element – A military intelligence organization under operational control to the G-2. The analysis and control element (ACE) is the primary military intelligence organization that assists the G-2 in synchronizing all reconnaissance and surveillance activities, and supporting the G-3 in integrating reconnaissance and surveillance tasks into the operation. The ACE also provides technical guidance, produces all-source intelligence, and disseminates targeting and intelligence data, as well as providing the threat and environmental portion of the common operational picture. Also called **ACE**. (FM 34-1)

analysis and control team – An organic team within the direct support military intelligence company that supports the maneuver brigade through situation development, intelligence preparation of the battlefield, and other intelligence tasks by the use of automated intelligence processing, analytical and dissemination capabilities. Also called **ACT**. (FM 34-1)

angle of depression – (NATO) 1. The angle in a vertical plane between the horizontal and a descending line. 2. In air photography, the angle between the optical axis of an obliquely mounted air camera and the horizon. Also called **depression angle**.

angle of safety – (NATO) The minimum permissible angular clearance, at the gun, of the path of a projectile above the friendly troops. It is the angle of clearance corrected to insure the safety of the troops. Also called **safety angle**.

angle T – (NATO) In artillery and naval fire support, the angle formed by the intersection of the gun-target line and the observer-target line. [Note: the Army definition also applies to mortar fire.] See FM 6-30.

antiterrorism – (DOD) Defensive measures used to reduce the vulnerability of individuals and property to terrorist acts, to include limited response and containment by local military forces. Also called **AT**. See also **counterterrorism; terrorism**.

apportionment – (DOD) In the general sense, distribution for planning of limited resources among competing requirements. Specific apportionments (e.g., air sorties and forces for planning) are described as apportionment of air sorties and forces for planning, etc. See also **allocation**. See 100-12.

approach march – (DOD, NATO) Advance of a combat unit when direct contact with the enemy is imminent. Troops are fully or partially deployed. The approach march ends when ground contact with the enemy is made or when the attack position is occupied. See also **movement to contact**. See FM 3-0.

area air defense commander – (DOD) Within a unified command, subordinate unified command, or joint task force, the commander will assign overall responsibility for air defense to a single commander. Normally, this will be the component commander with the preponderance of air defense capability and the command, control, and communications capability to plan and execute integrated air defense operations. Representation from other components involved will be provided, as appropriate, to the area air defense commander's headquarters. Also called **AADC**. See FM 44-100.

area assessment – (DOD) The commander's prescribed collection of specific information that commences upon employment and is a continuous operation. It confirms, corrects, refutes, or adds to previous intelligence acquired from area studies and other sources prior to employment. (Army) In unconventional warfare, the collection of specific information prescribed by the commander to commence immediately after infiltration. It is a continuous operation, and it confirms, corrects, refutes, or adds to intelligence required from area studies or other sources prior to infiltration. (FM 100-25)

area command – (DOD, NATO) A command which is composed of those organized elements of one or more Armed Services, designated to operate in a specific geographical area, which are placed under a single commander. (Army) In unconventional warfare, the organizational structure established within a joint special operations area to command and control resistance forces. It consists of the area commander, his staff, and representatives of the

resistance element, to include special forces after infiltration. See also **command**. (FM 100-25)

area damage control – (DOD, NATO) Measures taken before, during, or after hostile action or natural or manmade disasters to reduce the probability of damage and minimize its effects. Also called **ADC**. See FM 3-07.

area defense – A type of defensive operation that concentrates on denying enemy forces access to designated terrain for a specific time rather than destroying the enemy outright. (FM 3-0)

area of influence – (DOD, NATO) A geographical area wherein a commander is directly capable of influencing operations by maneuver and fire support systems normally under the commander's command or control. See FM 3-90.

area of intelligence responsibility – (DOD) An area allocated to a commander in which the commander is responsible for the provision of intelligence within the means at the commander's disposal. Also called **AOIR**. See also **area of interest**; **area of responsibility**.

area of interest – (DOD) That area of concern to the commander, including the area of influence, areas adjacent thereto, and extending into enemy territory to the objectives of current or planned operations. This area also includes areas occupied by enemy forces who could jeopardize the accomplishment of the mission. See also **area of influence**; **area of operations**; **battlespace**. See FM 3-0.

area of limitation – (DOD) A defined area where specific limitations apply to the strength and fortifications of disputing or belligerent forces. Normally, upper limits are established for the number and type of formations, tanks, antiaircraft weapons, artillery, and other weapons systems in the area of limitation. See also **line of demarcation**; **peace operations**. See FM 3-07.

area of operations – (DOD) An operational area defined by the joint force commander for land and naval forces. Areas of operations do not typically encompass the entire operational area of the joint force commander, but should be large enough for component commanders to accomplish their missions and protect their forces. Also called **AO**. See also **area of interest**; **area of responsibility**; **battlespace**; **joint operations area**; **joint special operations area**. See FM 3-0. (See page 7-35 for symbol.)

area of responsibility – (DOD) The geographical area associated with a combatant command within which a combatant commander has authority to plan and conduct operations. Also called **AOR**. See also **area of intelligence responsibility**; **combatant command**. See FM 3-0.

area of separation – See **buffer zone**.

area reconnaissance – A form of reconnaissance operations that is a directed effort to obtain detailed information concerning the terrain or enemy activity within a prescribed area. [Note: the Marine Corps definition adds "such as a town, ridge, line, woods, or other features critical to operations."] See also **reconnaissance**. (FM 3-90)

area security – A form of security operations conducted to protect friendly forces, installation routes, and actions within a specific area. See also **area reconnaissance**. (FM 3-90)

area, structures, capabilities, organizations, people, and events – See **ASCOPE**.

area support – Method of logistics, combat health support, and human resources support in which direct support (DS) combat service support relationships in effect are determined by the location of the units requiring support. Subordinate DS units provide area support to units located in or passing through their areas of responsibility. (FM 4-0)

ARFOR – The senior Army headquarters and all Army forces assigned or attached to a combatant command, subordinate joint force command, joint functional command, or multinational command. See also **joint force land component commander**. (FM 3-0)

armed helicopter – (DOD, NATO) A helicopter fitted with weapons or weapon systems. See FM 1-112. (See page 6-27 for symbol.)

armistice demarcation line – (DOD) A geographically defined line from which disputing or belligerent forces disengage and withdraw to their respective sides following a truce or cease fire agreement. Also called **cease fire line** in some United Nations operations. Also called **ADL**. See also **cease fire**; **peace operations**. See FM 3-07.

Army air movements – Operations involving the use of utility and rotary wing assets for other than air assaults. (FM 3-90)

Army airspace command and control – The Army's application of airspace control to coordinate airspace users for concurrent employment in the accomplishment of assigned missions. Also called **A2C2**. See also **airspace control order**. (FM 3-52)

Army Computer Emergency Response Team – A team that prevents, detects, assesses, and reports Army information systems security incidents. Also called **ACERT**. (FM 3-13)

Army reserve war stock – Materiel amassed in peacetime to meet the increase in military requirements at the outbreak of war. (FM 4-0)

Army service component command – The senior Army echelon in a theater and the Army component of a unified command. It includes the service component commander and all Army personnel, organizations, units, and installations that have been assigned to the unified command. (FM 100-7) (See page 5-36 for symbols.)

Army special operations forces – (DOD) Those Active and Reserve Component Army forces designated by the Secretary of Defense that are specifically organized, trained, and equipped to conduct and support special operations. Also called **ARSOF**. See FM 100-25.

Army special operations task force – A temporary or semi-permanent grouping of Army special operations forces units under one commander formed to carry out specific operations or a continuing mission. Also called **ARSOTF**. (FM 100-25)

artillery preparation – Artillery fire delivered before an attack to destroy, neutralize, or suppress the enemy's defense and to disrupt communications and disorganize the enemy's defense. A direct support field artillery battalion or higher echelon in coordination plans the preparation with the ground commander. It is an intense volume of fire delivered in accordance with a time schedule. The fires normally commence prior to H-hour and may extend beyond it. They may start at a prescribed time or be held on call. The duration of the preparation is influenced by factors such as the fire support needs of the entire force, number of targets and firing assets, and available ammunition. (FM 6-20-30)

art of command – The conscious and skillful exercise of the authority to fulfill command responsibilities through visualizing, deciding, directing, and leading. Art, as opposed to science, requires expert performance of a specific skill using intuitive faculties that cannot be solely learned by study or education. (FM 6-0)

art of tactics – The art of tactics consists of three interrelated aspects: the creative and flexible array of means to accomplish assigned missions, decisionmaking under conditions of uncertainty when faced with an intelligent enemy, and understanding the human dimension – the effects of combat on soldiers. (FM 3-90)

ASCOPE – A memory aid for the characteristics considered under civil considerations: areas, structures, capabilities, organizations, people, events. (FM 6-0)

assailable flank – A flank which is exposed to attack or envelopment. (FM 3-90)

assault – (DOD) 1. The climax of an attack, closing with the enemy in hand-to-hand fighting. See FM 3-90. 2. To make a short, violent, but well-ordered attack against a local objective, such as a gun emplacement, a fort, or a machine gun nest. See FM 3-90. 3. A phase of an airborne operation beginning with delivery by air of the assault echelon of the force into the objective area and extending through attack of assault objectives and consolidation of the initial airhead. See FM 90-26. See also **amphibious operation; assault force**.

assault command post – An austere temporary command post established to perform critical command and control functions. The assault command post serves as the early link in the assault or deployment between the forces on the ground and the next higher tactical force headquarters. Doctrinal command post functions are passed to the tactical, main, and rear command posts when they arrive and become operational. See also **command post; main command post; rear command post; tactical command post**. (See page 5-39 for symbol.)

assault echelon – (DOD) In amphibious operations, the element of a force comprised of tailored units and aircraft assigned to conduct the initial assault on the operational area. (NATO) The element of a force which is scheduled for initial assault on the objective area. See also **amphibious operation**. See FM 3-90.

assault fire – (DOD) 1. That fire delivered by attacking troops as they close with the enemy. See FM 7-8. 2. In artillery, extremely accurate, short-range destruction fire at point targets. See FM 6-30.

assault force – 1. In an amphibious, airborne, or air assault operation, those units charged with the seizure of the objective or lodgment area. (FM 90-26) 2. Those forces charged with passing through a breach in an enemy fortified position or strong point and seizing an objective or completing the destruction of the enemy. (FM 3-34.2) 3. Those forces charged with the seizure of the objective in the attack. (FM 7-20) See also **breach force; support force**.

assault phase – (DOD, NATO) In an airborne operation, a phase beginning with delivery by air of the assault echelon of the force into the objective area and extending through attack of assault objectives and consolidation of the initial airhead. See FM 90-26. (Army) That period during an attack which begins when the assault forces advance from their assault position and ends when the objective has been seized and consolidated. (FM 3-90). See also **air assault operation; airborne operation; amphibious operation; river crossing**.

assault position – (Army) A covered and concealed position short of the objective, from which final preparations are made to assault the objective. (FM 3-90) (Marine Corps) That position between the line of departure and the objective in an attack from which forces assault the objective. Ideally, it is the last covered and concealed position before reaching the objective (primarily used by dismounted infantry). See also **limit of advance**; **probable line of deployment**. (See page 7-31 for symbol.)

assault time – The assault time establishes the moment to attack the initial objective throughout the geographical scope of the operation. (FM 3-90)

assembly area – (DOD, NATO) – 1. An area in which a command is assembled preparatory to further action. 2. In a supply installation, the gross area used for collecting and combining components into complete units, kits, or assemblies. (Army) The area a unit occupies to prepare for an operation. Also called **AA**. (FM 3-90) (See page 7-16 for symbol.)

assessment – (DOD) 1. Analysis of the security, effectiveness, and potential of an existing or planned intelligence activity. 2. Judgment of the motives, qualifications, and characteristics of present or prospective employees or “agents.” (Army) The continuous monitoring—throughout planning, preparation, and execution—of the current situation and progress of an operation and the evaluation of it against criteria of success to make decisions and adjustments. (FM 3-0).

asset (intelligence) – (DOD) Any resource—person, group, relationship, instrument, installation, or supply—at the disposition of an intelligence organization for use in an operational or support role. Often used with a qualifying term, such as agent asset or propaganda asset.

assign – (DOD, NATO) 1. To place units or personnel in an organization where such placement is relatively permanent, and/or where such organization controls and administers the units or personnel for the primary function, or greater portion of the functions, of the unit or personnel. 2. To detail individuals to specific duties or functions where such duties or functions are primary and/or relatively permanent. See also **attach**. See FM 6-0.

assigned forces – Those forces that have been placed under the combatant command (command authority) of a unified commander by the Secretary of Defense. Forces and resources so assigned are available for normal peacetime operations of that command. (FM 3-0)

asymmetry – Dissimilarities in organization, equipment, doctrine, and values between other armed forces (formally organized or not) and US forces. Engagements are symmetric if forces, technologies, and weapons are similar; they are asymmetric if forces, technologies, and weapons are different, or if a resort to terrorism and rejection of more conventional rules of engagement are the norm. (FM 3-0)

attach – (DOD) 1. The placement of units or personnel in an organization where such placement is relatively temporary. 2. The detailing of individuals to specific functions where such functions are secondary or relatively temporary, e.g., attached for quarters and rations; attached for flying duty. See also **assign**; **operational command**; **operational control**; **organic**. See FM 6-0.

attack – (Army) An offensive operation that destroys or defeats enemy forces, seizes and secures terrain, or both. (FM 3-0) (Marine Corps) An offensive action characterized by movement supported by fire with the objective of defeating or destroying the enemy. See also

counterattack; deliberate attack; demonstration; feint; hasty attack; offensive operations; raid; spoiling attack.

attack by fire – A tactical mission task in which a commander uses direct fires, supported by indirect fires, to engage an enemy without closing with him to destroy, suppress, fix, or deceive him. See also **frontal attack; support by fire**. (FM 3-90) (See page 7-32 for symbol.)

attack by fire position – A position that designates the general position from which a unit conducts the tactical mission task of attack by fire. See also **attack by fire**. (FM 3-90)

attack helicopter – (DOD, NATO) A helicopter specifically designed to employ various weapons to attack and destroy enemy targets. See FM 1-112. (See page 6-27 for symbol.)

attack operations – One of the four operational elements of theater missile defense. Offensive actions intended to destroy and disrupt enemy theater missile (TM) capabilities before, during, and after launch. The objective of attack operations is to prevent the launch of TMs by attacking each element of the overall system, including such actions as destroying launch platforms; reconnaissance, surveillance, and target acquisition (RSTA) platforms; command and control nodes; and missile stocks and infrastructure. This is the preferred method of countering enemy TM operations. See also **active defense; passive defense; theater missile defense**. (FM 100-12)

attack position – (DOD) The last position occupied by the assault echelon before crossing the line of departure. See also **assault position**. See FM 3-90. (See page 7-32 for symbols.)

authenticate – (DOD) A challenge given by voice or electrical means to attest the authenticity of a message or transmission. See FM 11-32. (Army) A procedure word meaning, “The station called is to reply to the challenge which follows (insert text)”. See also **procedure word**. (FM 24-19)

authentication – (DOD) 1. A security measure designed to protect a communications system against acceptance of a fraudulent transmission or simulation by establishing the validity of a transmission, message, or originator. See FM 11-32. 2. A means of identifying individuals and verifying their eligibility to receive specific categories of information. See FM 34-1. 3. Evidence by proper signature or seal that a document is genuine and official. 4. In evasion and recovery operations, the process whereby the identity of an evader is confirmed. See FM 100-25.

authentication is – A procedure word meaning, “The transmission authentication of this message is (insert text)”. See also **procedure word**. (FM 24-19)

authorized stockage list – A list of items from all classes of supply authorized to be stocked at a specific echelon of supply. Also called **ASL**. (FM 4-0)

autoignition temperature – The temperature at which a chemical can spontaneously ignite. (FM 3-100.4)

automatic resupply – (DOD) A resupply mission fully planned before insertion of a special operations team into the operations area that occurs at a prearranged time and location, unless changed by the operating team after insertion. See also **emergency resupply; on-call resupply**. See FM 100-25.

auxiliary – In unconventional warfare, that element of the resistance force established to provide the organized civilian support of the resistance movement. (FM 100-25)

avenue of approach – (DOD) An air or ground route of an attacking force of a given size leading to its objective or to key terrain in its path. Also called **AA**. See FM 3-90.

aviation combat element – (Marine Corps) The core element of a Marine air-ground task force (MAGTF) that is task-organized to conduct aviation operations. The aviation combat element provides all or a portion of the six functions of Marine aviation necessary to accomplish the MAGTF's mission. These functions are antiair warfare, offensive air support, assault support, electronic warfare, air reconnaissance, and control of aircraft and missiles. The aviation combat element is usually composed of an aviation unit headquarters and various other aviation units or their detachments. It can vary in size from a small aviation detachment of specifically required aircraft to one or more Marine aircraft wings. In a joint or multinational environment, the aviation combat element may contain other Service or multinational forces assigned or attached to the MAGTF. The aviation combat element itself is not a formal command. Also called **ACE**.

axis – (NATO) In land warfare, the general direction of movement, planned or achieved, usually between assigned boundaries. See FM 3-90.

axis of advance – (DOD) A line of advance assigned for purposes of control; often a road or a group of roads, or a designated series of locations, extending in the direction of the enemy. (Army) An axis of advance designates the general area through which the bulk of a unit's combat power must move. See also **attack; direction of attack; movement to contact; offensive operations**. (FM 3-90) (See page 7-28 for symbol.)

azimuth – (DOD) Quantities may be expressed in positive quantities increasing in a clockwise direction, or in X, Y coordinates where south and west are negative. They may be referenced to true north or magnetic north depending on the particular weapon system used. (Army) The horizontal angle, measured clockwise by degrees or mils between a reference direction and the line to an observed or designated point. There are three base (reference) directions or azimuths: true, grid, and magnetic azimuth. See also **grid azimuth; magnetic azimuth; true azimuth**. (FM 3-25.26)

azimuth angle – (DOD, NATO) An angle measured clockwise in the horizontal plane between a reference direction and any other line. See FM 3-25.26.

—B—

backbrief – A briefing by subordinates to the commander to review how subordinates intend to accomplish their mission. (FM 101-5)

backhaul – The use of transportation assets that, having deposited their primary loads, are available to remove personnel and materials from that location to another location en route to their return destination. (FM 55-1)

back tell – (DOD, NATO) The transfer of information from a higher to a lower echelon of command. See also **track telling**.

ballistic missile – (DOD, NATO) Any missile which does not rely upon aerodynamic surfaces to produce lift and consequently follows a ballistic trajectory when thrust is terminated. See FM 44-100.

bangalore torpedo – A manually emplaced, explosive-filled pipe that was designed as a wire breaching device, but is also effective against simple pressure activated antipersonnel mines. It is issued as a demolition kit and consists of ten 1.5-meter tubes. Each tube contains 4 kilograms of high explosives and weighs 6 kilograms. A kit clears a 1-meter by 15-meter lane. (FM 3-34.2)

barrage – (DOD) 1. A prearranged barrier of fires, except that delivered by small arms, designed to protect friendly troops and installations by impeding enemy movements across defensive lines or areas. See FM 6-30. 2. A protective screen of balloons that is moored to the ground and kept at given heights to prevent or hinder operations by enemy aircraft. This meaning also called **barrage balloon**. 3. A type of electronic attack intended for simultaneous jamming over a wide area of frequency spectrum. See FM 34-45.

barrage fire – (DOD, NATO) Fire which is designed to fill a volume of space or an area rather than aimed specifically at a given target. See also **call for fire**. See FM 6-30.

barrage jamming – (DOD) Simultaneous electromagnetic jamming over a broad band of frequencies. See also **jamming**. See FM 34-1.

barrier – (DOD) A coordinated series of obstacles designed or employed to channel, direct, restrict, delay, or stop the movement of an opposing force and to impose additional losses in personnel, time, and equipment on the opposing force. Barriers can exist naturally, be manmade, or a combination of both. See also **abatis**; **countermobility operations**; **obstacle**. See FM 5-100.

base – (DOD, NATO) 1. A locality from which operations are projected or supported. 2. An area or locality containing installations which provide logistic or other support. 3. (DOD only) Home airfield or home carrier. See FM 3-90.

base cluster – (DOD) In base defense operations, a collection of bases, geographically grouped for mutual protection and ease of command and control. See also **base**. See FM 3-90.

base cluster operations center – (DOD) A command and control facility that serves as the base cluster commander's focal point for defense and security of the base cluster. Also called **BCOC**. See also **base cluster**. See FM 3-90.

base defense – (DOD) The local military measures, both normal and emergency, required to nullify or reduce the effectiveness of enemy attacks on, or sabotage of, a base, to ensure that the maximum capacity of its facilities is available to US forces. See FM 3-90.

base defense operations center – (DOD) A command and control facility established by the base commander to serve as the focal point for base security and defense. It plans, directs, integrates, coordinates, and controls all base defense efforts, and coordinates and integrates into area security operations with the rear area operations center/rear tactical operations center. Also called **BDOC**. See FM 3-90. (See page 5-39 for symbol.)

base defense reaction forces – Forces comprised of personnel or elements of units assigned to a specific base with the responsibility to rapidly bolster base defenses or react to an unforeseen threat. (FM 3-90)

base defense zone – (DOD) An air defense zone established around an air base and limited to the engagement envelope or short-range air defense weapons systems defending that base.

Base defense zones have specific entry, exit, and identification, friend or foe procedures established. Also called **BDZ**. See also **air defense**; **base defense**. See FM 44-100.

base development (less force beddown) – (DOD) The acquisition, development, expansion, improvement, and construction and/or replacement of the facilities and resources of an area or location to support forces employed in military operations or deployed in accordance with strategic plans. (NATO) The improvement or expansion of the resources and facilities of an area or a location to support military operations. See also **base**. See FM 5-100.15

base element – See **base unit**.

baseline intelligence capabilities – Operational capabilities of fielded Army intelligence and electronic warfare systems to detect intelligence targets, collect and process information, and produce and disseminate intelligence on a threat. These system capabilities should be grouped by discipline and assessed across all disciplines when evaluating detection, collection, and processing capabilities against a threat. (FM 34-1)

base of fire – (Army/Marine Corps) Fire [Note: the Army definition specifies “direct fire” here] placed on an enemy force or position to reduce or eliminate the enemy’s capability to interfere by fire and/or movement with friendly maneuver element(s). It may be provided by a single weapon or a grouping of weapons systems. See also **overwatch**; **support by fire**. See FM 7-20.

base unit – (DOD) Unit of organization in a tactical operation around which a movement or maneuver is planned and performed. See FM 3-90.

basic load – (DOD, NATO) The quantity of supplies required to be on hand within, and which can be moved by, a unit or formation. It is expressed according to the wartime organization of the unit or formation and maintained at the prescribed levels. See FM 10-27.

battalion – A unit consisting of two or more company-, battery-, or troop-sized units and a headquarters. Also called **bn**. (FM 3-90) (See page 5-33 for symbol.)

battery – (DOD, NATO) 1. Tactical and administrative artillery unit or subunit corresponding to a company or similar unit in other branches of the Army. See FM 6-20. 2. All guns, torpedo tubes, searchlights, or missile launchers of the same size or caliber or used for the same purpose, either installed in one ship or otherwise operating as an entity. (See page 5-33 for symbol.)

battle – A set of related engagements that lasts longer and involves larger forces than an engagement. See also **campaign**; **engagement**; **major operation**. (FM 3-0)

battle captain – The shift officer in charge within a command post, associated by position and not rank. The battle captain is located in the operations section of a command post and oversees the conduct of command post operations during his shift. The battle captain ensures that relevant information is given to decisionmakers and works closely with all members of the command group and staff.

battle command – The exercise of command in operations against a hostile, thinking enemy. (FM 3-0)

battle damage assessment – (DOD) The timely and accurate estimate of damage resulting from the application of military force, either lethal or nonlethal, against a predetermined

objective. Battle damage assessment can be applied to the employment of all types of weapon systems (air, ground, naval, and special forces weapons systems) throughout the range of military operations. Battle damage assessment is primarily an intelligence responsibility with required inputs and coordination from the operators. Battle damage assessment is composed of physical damage assessment, functional damage assessment, and target system assessment. See FM 34-1. (Marine Corps) In Marine Corps usage, the timely and accurate estimate of the damage resulting from the application of military force. Battle damage assessment estimates physical damage to a particular target, functional damage to that target, and the capability of the entire target system to continue its operations. Also called **BDA**.

battle damage repair – (DOD) Essential repair, which may be improvised, carried out rapidly in a battle environment in order to return damaged or disabled equipment to temporary service. Also called **BDR**. See also **cannibalize**. See FM 4-30.3.

battle drill – Standardized actions made in response to common battlefield occurrences. They are designed for rapid reaction situations. (FM 7-10)

battlefield coordination detachment – (DOD) An Army liaison provided by the Army component or force commander to the air operations center (AOC) and/or to the component designated by the joint force commander to plan, coordinate, and deconflict air operations. The battlefield coordination detachment processes Army requests for air support, monitors and interprets the land battle situation for the AOC, and provides the interface for exchange of current intelligence and operational data. Also called **BCD**. See FM 100-13.

battlefield information coordination center – A subsection of the battalion and brigade S-2 section. It provides detailed control and coordination of intelligence collection, production, and dissemination, thus freeing the S-2 from routine tasks so that he can better manage the overall intelligence effort. Also called **BICC**. (FM 34-1)

battlefield operating systems – (Army) The physical means that tactical commanders use to execute operations and accomplish missions assigned by superior tactical- and operational-level commanders. The seven BOS are: a. **intelligence system**—the activity to generate knowledge of and products portraying the enemy and the environmental features required by a command planning, preparing, executing, and assessing operations; b. **maneuver system**—the movement of forces to achieve a position of advantage with respect to enemy forces. This system includes the employment of forces in combination with direct fire or fire potential. This system also includes the conduct of tactical tasks associated with force protection; c. **fire support system**—the collective and coordinated use of target-acquisition data, indirect-fire weapons, fixed-wing aircraft, offensive information operations, and other lethal and nonlethal means against targets located throughout an area of operations; d. **air defense system**—protects the force from missile attack, air attack, and aerial surveillance by any of the following: ballistic missiles, cruise missiles, conventional fixed- and rotary-wing aircraft, and unmanned aerial vehicles. It prevents enemies from interdicting friendly forces, while freeing commanders to synchronize movement and firepower; e. **mobility/countermobility/ survivability system**—mobility operations preserve the freedom of maneuver of friendly forces; counter mobility operations deny mobility to enemy forces; survivability operations protect friendly forces from the effects of enemy weapon systems; f. **combat service support system**—the support and services to sustain forces during full spectrum operations; g. **command and control system**—collective tasks associated with supporting the exercise of authority and direction by a properly designated

commander over assigned and available forces in the accomplishment of the mission. Also called **BOS**. (FM 7-15)

battlefield organization – The allocation of forces in the area of operations by purpose. It consists of three all-encompassing categories of operations: decisive, shaping, and sustaining. See also **decisive operations; shaping operations; sustaining operations**. (FM 3-0)

battlefield psychological activities – (DOD, NATO) Planned psychological activities conducted as an integral part of combat operations and designed to bring psychological pressure to bear on enemy forces and civilians under enemy control in the battle area, to assist in the achievement of operational and tactical objectives. See FM 3-05.30.

battle handover line – A designated phase line on the ground where responsibility transitions from the stationary force to the moving force and vice versa. Also called **BHL**. See also **handover line**. (FM 3-90)

battle position – (Army) 1. A defensive location oriented on a likely enemy avenue of approach. (FM 3-90) 2. For attack helicopters, an area designated in which they can maneuver and fire into a designated engagement area or engage targets of opportunity. (FM 1-112) (Marine Corps) 1. In ground operations, a defensive location oriented on an enemy avenue of approach from which a unit may defend. 2. In air operations, an airspace coordination area containing fire points for attack helicopters. Also called **BP**. (See page 7-25 for symbol.)

battlespace – (DOD) The environment, factors, and conditions that must be understood to successfully apply combat power, protect the force, or complete the mission. This includes air, land, sea, space, and the included enemy and friendly forces; facilities; weather; terrain; the electromagnetic spectrum; and the information environment within the operational areas and areas of interest. See also **electromagnetic spectrum; information environment; intelligence preparation of the battlefield; intelligence preparation of the battlespace**. See FM 3-0.

beach capacity – (DOD, NATO) An estimate, expressed in terms of measurement tons, or weight tons, of cargo that may be unloaded over a designated strip of shore per day. See FM 55-60.

beach group – See **shore party**

beachhead – (DOD, NATO) A designated area on a hostile or potentially hostile shore that, when seized and held, ensures the continuous landing of troops and materiel, and provides maneuver space requisite for subsequent projected operations ashore. See also **amphibious operation**. See FM 7-10.

beaten zone – (DOD) The area on the ground upon which the cone of fire falls. See also **cone of fire**. See FM 3-22.68.

begin morning civil twilight – (DOD) The period of time at which the sun is halfway between beginning morning and nautical twilight and sunrise, when there is enough light to see objects clearly with the unaided eye. At this time, light intensification devices are no longer effective, and the sun is six degrees below the eastern horizon. Also called **BMCT**. See also **begin morning nautical twilight; end evening civil twilight; end of evening nautical twilight**. See FM 34-130.

begin morning nautical twilight – (DOD) The start of that period where, in good conditions and in the absence of other illumination, enough light is available to identify the general outlines of ground objects and conduct limited military operations. Light intensification devices are still effective and may have enhanced capabilities. At this time the sun is 12 degrees below the eastern horizon. Also called **BMNT**. See also **begin morning civil twilight**; **end evening civil twilight**; **end of evening nautical twilight**. See FM 34-130.

beleaguered – (DOD) A casualty who is a member of an organized element that has been surrounded by a hostile force to prevent escape of its members. See also **missing**. See FM 4-02.

be-prepared mission – A mission assigned to a unit that might be executed. It is generally a contingency mission which will be executed because something planned has or has not been successful. In planning priorities, it is planned after any on-order missions. See also **on-order mission**. (FM 101-5)

besieged – (DOD) A casualty who is a member of an organized element that has been surrounded by a hostile force, compelling it to surrender. See also **missing**. See FM 4-02.

biographical intelligence – (DOD) That component of intelligence that deals with individual foreign personalities of actual or potential importance. (FM 34-1)

biological agent – (DOD) A microorganism that causes disease in personnel, plants, or animals or causes the deterioration of materiel. See also **biological marker**; **biological operation**; **chemical agent**. See FM 3-9.

biological marker – Characteristics of a biological agent (organism, virus, toxin, or product) that are specific to the agent. See also **biological agent**. (FM 4-02.7)

biological operation – (DOD) Employment of biological agents to produce casualties in personnel or animals and damage to plants. See also **biological agent**. See FM 3-9.

biological warfare agent definitive identification and confirmation – The specific identification of a suspect biological agent as to genus, species, serological type, or toxin. This level of identification is by means of devices, materials, and/or technologies that are based on two or more independent bio-marker results and using different methodologies. This level of identification is performed in a reference laboratory with a broader variety of methodologies available and highly skilled testing personnel, thus providing the highest levels of accuracy. See also **biological agent**; **biological marker**; **biological warfare agent field confirmation identification**; **biological warfare agent presumptive identification**. (FM 4-02.7)

biological warfare agent field confirmation identification – Identification of a suspect biological warfare agent by means of devices, materials, and/or technologies that are based on detecting biological markers using two or more independent bio-marker results. See also **biological agent**; **biological marker**; **biological warfare agent definitive identification and confirmation**; **biological warfare agent presumptive identification**. (FM 4-02.7)

biological warfare agent presumptive identification – Identification of a suspect biological warfare agent by means of devices, materials, and/or technologies that are based on detecting biological markers using a single methodology. The bio-markers and/or methodologies used at this level of testing have significant limits to their accuracy. See also **biological agent**;

biological marker; biological warfare agent definitive identification and confirmation; biological warfare agent field confirmation identification. (FM 4-02.7)

black propaganda – (DOD, NATO) Propaganda that purports to emanate from a source other than the true one. See FM 33-1-1.

blast effect – (DOD) Destruction of or damage to structures and personnel by the force of an explosion on or above the surface of the ground. Blast effect may be contrasted with the cratering and ground-shock effects of a projectile or charge that goes off beneath the surface. See FM 5-250.

blind transmission – (DOD) Any transmission of information that is made without expectation of acknowledgment. See FM 11-32.

blister agent – (DOD, NATO) A chemical agent which injures the eyes and lungs, and burns or blisters the skin. Also called **vesicant agent**. See FM 3-7.

block – 1. A tactical mission task that denies the enemy access to an area or prevents his advance in a direction or along an avenue of approach. 2. An obstacle effect that integrates fire planning and obstacle effort to stop an attacker along a specific avenue of approach or to prevent him from passing through an engagement area. See also **contain; disrupt; fix; turn**. (FM 3-90) (See pages 7-49 and A-2 for symbol.)

blocking position – (DOD, NATO) A defensive position so sited as to deny the enemy access to a given area or to prevent the enemy's advance in a given direction. See also **battle position; block; strong point**. See FM 3-90.

block minefield – A minefield used to achieve a block obstacle effect. Typically consists of a series of minefields arrayed to affect the entire width of an avenue of approach, but in relatively shallow depth. A block effect minefield is the most resource intensive type of minefield and must be capable of defeating mechanical and dismounted breach efforts. (FM 90-7).

blood agent – (DOD, NATO) A chemical compound, including the cyanide group, that affects bodily functions by preventing the normal utilization of oxygen by body tissues. See FM 3-07.

blood chit – (DOD) A small sheet of material depicting an American flag and a statement in several languages to the effect that anyone assisting the bearer to safety will be rewarded. See also **civil affairs**. See FM 41-10.

blowback – (DOD, NATO) 1. Escape, to the rear and under pressure, of gases formed during the firing of the weapon. Blowback may be caused by a defective breech mechanism, a ruptured cartridge case, or a faulty primer. 2. Type of weapon operation in which the force of expanding gases acting to the rear against the face of the bolt furnishes all the energy required to initiate the complete cycle of operation. A weapon which employs this method of operation is characterized by the absence of any breech-lock or bolt-lock mechanism. See FM 6-50.

booby trap – (DOD) An explosive or nonexplosive device or other material deliberately placed to cause casualties when an apparently harmless object is disturbed or a normally safe act is performed. (NATO) A device designed, constructed, or adapted to kill or injure, which functions when a person disturbs or approaches an apparently harmless object or performs an apparently safe act. See FM 20-32. (See page 7-46 for symbol.)

bound – (DOD, NATO) 1. In land warfare, a single movement, usually from cover to cover, made by troops often under enemy fire. 2. (DOD only) Distance covered in one movement by a unit that is advancing by bounds. See FM 3-90.

boundary – (DOD) A line that delineates surface areas for the purpose of facilitating coordination and deconfliction of operations between adjacent units, formations, or areas. See also **airhead**; **airspace coordination area**; **area of operations**; **bridgehead**. See FM 3-90. (See page 7-12 for symbols.)

bounding overwatch – A movement technique used when contact with enemy forces is expected. The unit moves by bounds. One element is always halted in position to overwatch another element while it moves. The overwatching element is positioned to support the moving unit by fire or fire and movement. See also **overwatch**. (FM 3-90)

box formation – A unit formation with subordinate elements arranged in a box or square, or two elements up and two elements back. It is a flexible formation that provides equal firepower in all directions. It is generally used when the enemy location is known. This formation can cause 50 percent of force to be decisively engaged at the same time, therefore limiting the combat power available to maneuver against an enemy. See also **column formation**; **echelon formation**; **formation**; **line formation**; **movement formation**; **vee formation**; **wedge formation**. (FM 3-90)

bracketing – (DOD, NATO) A method of adjusting fire in which a bracket is established by obtaining an over and a short along the spotting line, and then successively splitting the bracket in half until a target hit or desired bracket is obtained. See FM 6-30.

branch – (DOD) 1. A subdivision of any organization. 2. A geographically separate unit of an activity which performs all or part of the primary functions of the parent activity on a smaller scale. Unlike an annex, a branch is not merely an overflow addition. 3. An arm of service of the Army. 4. The contingency options built into the basic plan. A branch is used for changing the mission, orientation, or direction of movement of a force to aid success of the operation based on anticipated events, opportunities, or disruptions caused by enemy actions and reactions. (Army) A contingency plan or course of action (an option built into the basic plan or course of action) for changing the mission, disposition, orientation, or direction of movement of the force to aid success of the current operation, based on anticipated events, opportunities, or disruptions caused by enemy actions. Army forces prepare branches to exploit success and opportunities, or to counter disruptions caused by enemy actions. FM 3-0. See also **contingency plan**; **course of action**; **operation order**; **sequel**; **wargaming**.

breach – (Army) A tactical mission task in which the unit employs all available means to break through or secure a passage through an enemy defense, obstacle, minefield, or fortification. (FM 3-90) (Marine Corps) The employment of any means available to break through or secure a passage through an obstacle. (See page A-2 for symbol.)

breach area – The area where a breaching operation occurs. The breach area is established and fully defined by the higher headquarters of the unit conducting breaching operations. (FM 3-34.2)

breach force – A combined arms force task-organized with the maneuver and engineer forces necessary to reduce obstacles and create lanes through an obstacle to pass initial assault forces through the lanes. See also **assault force**; **support force**. (FM 3-34.2)

breaching fundamentals – Suppress, obscure, secure, reduce, and assault (SOSRA) are the breaching fundamentals that must be applied when breaching against a defending enemy. These fundamentals will always apply, but they may vary based on the specific battlespace situation. (FM 3-34.2)

breaching operations – Operations conducted to allow maneuver despite the presence of obstacles. Breaching is a synchronized combined arms operation under the control of the maneuver commander. Breaching operations begin when friendly forces detect an obstacle and begin to apply the breaching fundamentals, and they end when battle handover has occurred between follow-on forces and a unit conducting the breaching operation. (FM 3-34.2)

break – A procedure word meaning, “I hereby indicate the separation of the text from other portions of the message.” See also **procedure word**. (FM 24-19)

breakbulk cargo – (DOD) Any commodity that, because of its weight, dimensions, or incompatibility with other cargo, must be shipped by mode other than military van or SEAVAN. (Army) Cargo which is not shipped in a container. (FM 10-1)

breakout – An operation conducted by an encircled force to regain freedom of movement or contact with friendly units. It differs from other attacks only in that a simultaneous defense in other areas of the perimeter must be maintained. See also **encirclement; follow and support; main body; rear guard; rupture**. (FM 3-90)

breakthrough – A rupturing of the enemy’s forward defenses that occurs as a result of a penetration. A breakthrough permits the passage of an exploitation force. See also **attack; exploitation; pursuit**. (FM 3-90)

brevity code – (DOD, NATO) A code which provides no security but which has as its sole purpose the shortening of messages rather than the concealment of their content. See FM 3-54.10.

bridgehead – (DOD) An area of ground held or to be gained on the enemy’s side of an obstacle. (Army) In river crossing operations, an area on the enemy’s side of the water obstacle that is large enough to accommodate the majority of the crossing force, has adequate terrain to permit defense of the crossing sites, provides security of crossing forces from enemy direct fire, and provides a base for continuing the attack. (FM 90-13)

bridgehead force – A force that assaults across a river to secure the enemy side of a river (the bridgehead) to allow the buildup and passage of a breakout force during river crossing operations. (FM 90-13)

bridgehead line – (DOD, NATO) The limit of the objective area in the development of the bridgehead. See also **objective area**. See FM 90-13. (See page 7-34 for symbol.)

brigade – (DOD) A unit usually smaller than a division to which are attached groups and/or battalions and smaller units tailored to meet anticipated requirements. (Army) A unit consisting of two or more battalions and a headquarters. Also called **bde**. (FM 3-90) (See page 5-33 for symbol.)

brigade support area – A designated area in which combat service support elements from division support command and corps support command provide logistic support to a brigade. Also called **BSA**. (FM 7-30) (See page 7-70 for symbol.)

broadcast dissemination – The simultaneous dissemination of combat information, intelligence, targeting information, etc. to multiple terminals at multiple echelons in order to provide immediate combat information and intelligence. (FM 34-1)

buffer zone – (DOD) A defined area controlled by a peace operations force from which disputing or belligerent forces have been excluded. A buffer zone is formed to create an area of separation between disputing or belligerent forces and reduce the risk of renewed conflict. Also called **area of separation** in some United Nations operations. Also called **BZ**. See FM 3-07.

buildup – (DOD, NATO) The process of attaining prescribed strength of units and prescribed levels of vehicles, equipment, stores, and supplies. Also may be applied to the means of accomplishing this process. See FM 100-17.

bulk cargo – (DOD) That which is generally shipped in volume where the transportation conveyance is the only external container, such as liquids, ore, or grain. (Army) Cargo with dimensions less than oversized cargo and cargo that fits on a 463L aircraft pallet. (FM 4-01.30).

bulk petroleum product – (DOD, NATO) A liquid petroleum product transported by various means and stored in tanks or containers having an individual fill capacity greater than 250 liters. See FM 10-67.

bulk storage – (DOD) 1. Storage in a warehouse of supplies and equipment in large quantities, usually in original containers, as distinguished from bin storage. 2. Storage of liquids, such as petroleum products, in tanks, as distinguished from drum or packaged storage. See also **bulk cargo**; **bulk petroleum product**. See FM 10-67.

bump plan – In movement, a plan that describes in detail which individuals and equipment in each designated load or chalk has priority over the others. This plan is used when the means of transportation (truck, helicopter, airplane, or ship) cannot carry all of a particular load. See also **chalk**. (FM 55-1)

bypass – A tactical mission task in which the commander directs his unit to maneuver around an obstacle, avoiding combat with an enemy force. (FM 3-90) (See pages 7-52 and A-2 for symbol.)

bypass criteria – Measures during the conduct of an offensive operation established by higher headquarters that specify the conditions and size under which enemy units and contact may be avoided. (FM 3-90)

—C—

calculated risk – An exposure to chance of injury or loss when the commander can visualize the outcome in terms of mission accomplishment or damage to the force, and judges the outcome as worth the cost. (FM 6-0)

call for fire – (DOD, NATO) A request for fire containing data necessary for obtaining the required fire on a target. See FM 6-30.

call forward area – 1. In river crossing operations, waiting areas within the crossing area where final preparations are made. (FM 90-13) 2. In air movement, the area at the departure airfield where plane loads are assembled in a ready condition prior to being directed to the

loading ramp area. (FM 55-1) See also **aerial port of embarkation; airborne; chalk; staging area; tanker airlift control element.**

camouflage – (DOD, NATO) The use of natural or artificial material on personnel, objects, or tactical positions with the aim of confusing, misleading, or evading the enemy. See also **concealment; cover; deception; surveillance.** See FM 7-10.

camp – A group of tents, huts, or shelters set up temporarily for troops, and more permanent than a bivouac. A military post, temporary or permanent, may be called a camp.

campaign – (DOD) A series of related military operations aimed at accomplishing a strategic or operational objective within a given time and space. See also **campaign plan.** See FM 3-0.

campaign plan – (DOD) A plan for a series of related military operations aimed at accomplishing a strategic or operational objective within a given time and space. See also **campaign.** See FM 3-0.

canalize – (DOD) To restrict operations to a narrow zone by use of existing or reinforcing obstacles or by fire or bombing. (Army) A tactical mission task in which the commander restricts enemy movement to a narrow zone by exploiting terrain coupled with the use of obstacles, fires, or friendly maneuver. See also **obstacle.** (FM 3-90) (See page A-2 for symbol.)

cancel – (NATO) In artillery and naval fire support, the term cancel, when coupled with a previous order, other than an order for a quantity or type of ammunition, rescinds that order. [Note: the Army definition also applies to mortar fire.] See FM 6-30.

cannibalize – (DOD) To remove serviceable parts from one item of equipment in order to install them on another item of equipment. (NATO) To remove serviceable assemblies, sub-assemblies or components from a repairable or serviceable item of equipment in order to install them on another. See also **battle damage assessment; battle damage repair.** See FM 4-30.3.

captured – (DOD) A casualty who has been seized as a result of action of an unfriendly military or paramilitary force in a foreign country. See also **missing.** See FM 4-02.

captured document – Any document that was in the possession of a threat force that subsequently comes into the hands of a friendly force, regardless of the origin of that document. (FM 34-52)

casualty – (DOD) Any person who is lost to the organization by having been declared dead, duty status-whereabouts unknown, missing, ill, or injured. (Army) Any person who is lost to his organization by reason of having been declared dead, wounded, injured, diseased, interned, captured, retained, missing in action, beleaguered, besieged, or detained. (FM 8-55)

casualty collection point – A specific location where casualties are assembled to be transported to a medical treatment facility, for example, a company aid post. Also called **CCP.** (FM 8-10-6) (See page 7-62 for symbol.)

casualty evacuation – (DOD) The movement of casualties. It includes movement both to and between medical treatment facilities. Any vehicle may be used to evacuate casualties. (Army) A term used by nonmedical units to refer to the movement of casualties aboard nonmedical vehicles or aircraft. (FM 8-10-6) (Marine Corps) The movement of the sick, wounded, or

injured. It begins at the point of injury or the onset of disease. It includes movement both to and between medical treatment facilities. All units have an evacuation capability. Any vehicle may be used to evacuate casualties. If a medical vehicle is not used it should be replaced with one at the first opportunity. Similarly, aeromedical evacuation should replace surface evacuation at the first opportunity. Also called **CASEVAC**.

casualty transport – See **casualty evacuation**.

C-day – (DOD) The unnamed day on which a deployment operation commences or is to commence. The deployment may be movement of troops, cargo, weapon systems, or a combination of these elements using any or all types of transport. The letter “C” will be the only one used to denote the above. The highest command or headquarters responsible for coordinating the planning will specify the exact meaning of C-day within the aforementioned definition. The command or headquarters directly responsible for the execution of the operation, if other than the one coordinating the planning, will do so in light of the meaning specified by the highest command or headquarters coordinating the planning. See also **times**. See FM 101-5.

cease engagement – (NATO) In air defense, a fire control order used to direct units to stop the firing sequence against a designated target. Guided missiles already in flight will continue to intercept. See also **engage**; **hold fire**. See FM 44-100.

cease fire – (DOD) 1. A command given to any unit or individual firing any weapon to stop engaging the target. 2. A command given to air defense artillery units to refrain from firing on, but to continue to track, an airborne object. Missiles already in flight will be permitted to continue to intercept. See also **call for fire**; **fire command**; **fire mission**. See FM 6-50.

cease fire line – See **armistice demarcation line**.

cease loading – (NATO) In artillery and naval fire support, the command used during firing of two or more rounds to indicate the suspension of inserting rounds into the weapon. [Note: the Army definition also applies to mortar fire.] See FM 6-50.

cell – (DOD) Small group of individuals who work together for clandestine or subversive purposes. See FM 3-05.20.

centers of gravity – (DOD) Those characteristics, capabilities, or sources of power from which a military force derives its freedom of action, physical strength, or will to fight. Also called **COGs**. See also **operational art**; **operational level of war**. See FM 3-0

centigray – (DOD, NATO) A unit of absorbed dose of radiation (one centigray equals one rad). See also **decontamination**. See FM 3-3-1.

chaff – (DOD) Radar confusion reflectors consisting of thin, narrow metallic strips of various lengths and frequency responses, which are used to reflect echoes for confusion purposes. Causes enemy radar guided missiles to lock on to it instead of the real aircraft, ship, or other platform. See also **deception**. See FM 3-04.111.

chain of command – (DOD, NATO) The succession of commanding officers from a superior to a subordinate through which command is exercised. Also called **command channel**. See FM 6-0.

chalk – Designated troops, equipment, or cargo that constitutes a complete aircraft load. See also **air assault**; **airborne**; **tanker airlift control element**. (FM 90-26)

chalk number – (DOD, NATO) The number given to a complete load and to the transporting carrier. See also **chalk**. See FM 90-26.

challenge – (DOD, NATO) Any process carried out by one unit or person with the object of ascertaining the friendly or hostile character or identity of another. See also **password**. See FM 11-43.

charge – (NATO) 1. The amount of propellant required for a fixed, semi-fixed, or separate loading projectile, round or shell. It may also refer to the quantity of explosive filling contained in a bomb, mine or the like. 2. In combat engineering, a quantity of explosive, prepared for demolition purposes. See also **cratering charge**; **shaped charge**. See FM 5-250.

check firing – (DOD, NATO) In artillery and naval gunfire support, a command to cause a temporary halt in firing. [Note: the DOD definition also applies to mortar fire.] See also **cease fire**; **cease loading**; **fire mission**. See FM 6-20-30.

checkpoint – (DOD, NATO) 1. A predetermined point on the surface of the Earth used as a means of controlling movement, a registration target for fire adjustment, or reference for location. 2. Center of impact; a burst center. 3. Geographical location on land or water above which the position of an aircraft in flight may be determined by observation or by electrical means. 4. A place where military police check vehicular or pedestrian traffic in order to enforce circulation control measures and other laws, orders, and regulations. See FM 3-19.4. (Army) Predetermined point on the ground used to control movement, tactical maneuver, and orientation. Also called **CP**. (FM 3-90) (See page 7-42 for symbol.)

chemical agent – (DOD) Any toxic chemical intended for use in military operations. (NATO) A chemical substance which is intended for use in military operations to kill, seriously injure, or incapacitate personnel through its physiological effects. The term excludes riot control agents, herbicides, and substances generating smoke and flames. See FM 3-9.

chemical defense – (DOD, NATO) The methods, plans, and procedures involved in establishing and executing defensive measures against attack utilizing chemical agent. See also **chemical agent**; **decontamination**; **nuclear, biological, and chemical defense**. See FM 3-11.

chemical downwind message – A weather forecast valid for three 2-hour periods (6 hours). The chemical downwind message forecasts wind direction, wind speed, air stability, humidity, air temperature, and any significant weather. Also called **CDM**. See also **decontamination**; **mission-oriented protective posture**. (FM 3-3-1)

chemical warfare – (DOD) All aspects of military operations involving the employment of lethal and incapacitating munitions/agents and the warning and protective measures associated with such offensive operations. Since riot control agents and herbicides are not considered to be chemical warfare agents, those two items will be referred to separately or under the broader term “chemical,” which will be used to include all types of chemical munitions/agents collectively. Also called **CW**. See also **chemical agent**; **chemical defense**; **herbicide**; **riot control agent**. See FM 3-11.

circular error probable – (DOD) An indicator of the delivery accuracy of a weapon system, used as a factor in determining probable damage to a target. It is the radius of a circle within which half of a missile's projectiles are expected to fall. (Army) Error in location of a system or vehicle based on the on-board navigational system and the distance from the last survey control point. Also called **CEP**. (FM 6-30)

civil administration – (DOD) An administration established by a foreign government in (1) friendly territory, under an agreement with the government of the area concerned, to exercise certain authority normally the function of the local government, or (2) hostile territory occupied by United States forces, where a foreign government exercises executive, legislative, and judicial authority until an indigenous civil government can be established. Also called **civil affairs administration**. Also called **CA administration**. See also **civil affairs**; **civil-military operations**; **stability operations**. See FM 41-10.

civil affairs – (DOD) Designated Active and Reserve Component forces and units organized, trained, and equipped specifically to conduct civil affairs activities and to support civil-military operations. Also called **CA**. See also **civil affairs activities**; **civil-military operations**. See FM 41-10 (See page 5-32 for symbol.)

civil affairs activities – (DOD) Activities performed or supported by civil affairs that (1) enhance the relationship between military forces and civil authorities in areas where military forces are present; and (2) involve application of civil affairs functional specialty skills, in areas normally the responsibility of civil government, to enhance conduct of civil-military operations. See also **civil affairs**; **civil military operations**. See FM 41-10.

civil affairs administration – See **civil administration**.

civil considerations – How the manmade infrastructure, civilian institutions, and attitudes and activities of the civilian leaders, populations, and organizations within an area of operations influence the conduct of military operations. (FM 6-0)

civil defense emergency – (DOD) A domestic emergency disaster situation resulting from devastation created by an enemy attack and requiring emergency operations during and following that attack. It may be proclaimed by appropriate authority in anticipation of an attack. See also **domestic emergencies**. See FM 3-07.

civil disturbances – (DOD) Riots, acts of violence, insurrections, unlawful obstructions or assemblages, or other disorders prejudicial to public law and order. The term "civil disturbances" includes all domestic conditions requiring or likely to require the use of Federal Armed Forces pursuant to the provisions of Chapter 15 of Title 10, United States Code. See also **domestic emergencies**. See FM 3-07.

civil-military operations – (DOD) The activities of a commander that establish, maintain, influence, or exploit relations between military forces, governmental and nongovernmental civilian organizations and authorities, and the civilian populace in a friendly, neutral, or hostile operational area in order to facilitate military operations, to consolidate and achieve US objectives. Civil-military operations may include performance by military forces of activities and functions normally the responsibility of the local, regional, or national government. These activities may occur prior to, during, or subsequent to other military actions. They may also occur, if directed, in the absence of other military operations. Civil-military operations may be performed by designated civil affairs, by other military forces, or

by a combination of civil affairs and other forces. Also called **CMO**. See also **civil affairs activities**. See FM 41-10.

civil-military operations center – (DOD) An ad hoc organization [Note: the Army definition uses “coordination center”], normally established by the geographic combatant commander or subordinate joint force commander, to assist in the coordination of activities of engaged military forces, and other United States government agencies, nongovernmental organizations, and regional and international organizations. There is no established structure, and its size and composition are situation dependent. Also called **CMOC**. See also **civil affairs activities; civil-military operations**. See FM 41-10.

civil supply – A functional specialty within the Economics and Commerce Team of a civil affairs command. The Economics and Commerce Team consists of functional specialists in food and agriculture, economic development, and civilian supply. It provides technical expertise, planning, development, and staff advice to the supported command. (FM 41-10)

clandestine operation – (DOD) An operation sponsored or conducted by governmental departments or agencies in such a way as to assure secrecy or concealment. A clandestine operation differs from a covert operation in that emphasis is placed on concealment of the operation rather than on concealment of the identity of the sponsor. In special operations, an activity may be both covert and clandestine and may focus equally on operational considerations and intelligence-related activities. See also **covert operation; overt operation**. See FM 3-05.20.

classes of supply – (DOD) There are ten categories into which supplies are grouped to facilitate supply management and planning. (See page 7-65 for symbols and for equivalent NATO classes of supply.) These classes are:

- I Rations and gratuitous issue health, morale, and welfare items.
- II Clothing, individual, equipment, tentage, tool sets, and administrative and housekeeping supplies and equipment.
- III Petroleum, oils, and lubricants.
- IV Construction materials.
- V Ammunition.
- VI Personal demand items.
- VII Major end items, including tanks, helicopters, and radios.
- VIII Medical.
- IX Repair parts and components for equipment maintenance.
- X Nonstandard items to support nonmilitary programs, such as agriculture and economic development.

[Note: the Army definition also has a miscellaneous category comprising water, captured enemy material, and salvage material.] See FM 4-0.

clear – (DOD) 1. To approve or authorize, or obtain approval or authorization for: a. a person or persons with regard to their actions, movements, duties, etc.; b. an object or group of objects, as equipment or supplies, with regard to quality, quantity, purpose, movement, disposition, etc.; and c. a request, with regard to correctness of form, validity, etc. 2. To give one or more aircraft a clearance. 3. To give a person a security clearance. 4. To fly over an obstacle without touching it. 5. To pass a designated point, line, or object. The end of a column must pass the designated feature before the latter is cleared. 6. a. To operate a gun so as to unload it or make certain no ammunition remains; and b. to free a gun of stoppages. 7. To clear an engine; to open the throttle of an idling engine to free it from carbon. 8. To clear the air to gain either temporary or permanent air superiority or control in a given sector. (Army) 1. A tactical mission task that requires the commander to remove all enemy forces and eliminate organized resistance in an assigned area. (FM 3-90) 2. To eliminate transmissions on a tactical radio net in order to allow a higher-precedence transmission to occur. (FM 11-32) 3. The total elimination or neutralization of an obstacle that is usually performed by follow-on engineers and is not done under fire. (FM 3-34.2) See also **reduce**. (See page A-2 for symbol.)

clearance of fires – The process of approving or obtaining approval to attack targets with indirect fires within and outside the boundaries of the maneuver unit for which the fires are provided. (FM 6-30)

clearing operation – (DOD) An operation designed to clear or neutralize all mines and obstacles from a route or area. See also **breach**. See FM 3-34.2.

close air support – (DOD) Air action by fixed- and rotary-wing aircraft against hostile targets that are in close proximity to friendly forces and which require detailed integration of each air mission with the fire and movement of those forces. Also called **CAS**. See also **air interdiction**; **air support**; **immediate mission request**; **preplanned mission request**. See FM 3-52.

close area – Where forces are in immediate contact with the enemy and the fighting between the committed forces and readily available tactical reserves of both combatants is occurring, or where commanders envision close combat taking place. Typically, the close area assigned to a maneuver force extends from the subordinates' rear boundaries to its own forward boundary. (FM 3-0)

close combat – Combat carried out with direct fire weapons, supported by indirect fire, air-delivered fires, and nonlethal engagement means. Close combat defeats or destroys enemy forces or seizes and retains ground. (FM 3-0)

close quarters battle – Sustained combative tactics, techniques, and procedures employed by small, highly trained special operations forces using special purpose weapons, munitions, and demolitions to recover specified personnel, equipment, or material. Also called **CQB**. (FM 100-25)

cluster – (NATO) 1. Fireworks signal in which a group of stars burns at the same time. 2. Group of bombs released together. A cluster usually consists of fragmentation or incendiary bombs. 3. Two or more parachutes for dropping light or heavy loads. See FM 4-20.41. 4. In land mine warfare, a component of a pattern-laid minefield. It may be antitank, antipersonnel, or mixed. It consists of one to five mines and no more than one antitank mine. See FM 20-32. 5. In minehunting, designates a group of mine-like contacts. See FM 20-32. 6. Two or more engines coupled together so as to function as one power unit. See FM 55-20. 7. In naval mine

warfare, a number of mines laid in close proximity to each other as a pattern or coherent unit. They may be of mixed types.

clutter – (DOD) Permanent echoes, cloud, or other atmospheric echo on radar scope as contact has entered scope clutter. See also **air defense**. See FM 44-100.

coalition – (DOD) An ad hoc arrangement between two or more nations for common action. See also **alliance**; **multinational operations**. See FM 100-8.

coil – An arrangement of vehicles forming a circle and providing 360-degree security in an assembly area with the primary weapon systems and protective armor facing outward. (FM 3-90.1)

collaborative planning – The real-time interaction among commanders and staffs at two or more echelons developing plans for a particular operation. (FM 101-5)

collateral activities – The inherent capabilities of all military forces that may periodically be applied to accomplish missions other than those for which the forces are principally organized, trained, and equipped. Collateral activities in which special operations forces, by virtue of inherent capabilities, may be tasked to participate include humanitarian assistance, security assistance, search and rescue, antiterrorism, and other security activities and special activities. (FM 100-25)

collateral damage – (DOD) Unintentional or incidental injury or damage to persons or objects that would not be lawful military targets in the circumstances ruling at the time. Such damage is not unlawful so long as it is not excessive in light of the overall military advantage anticipated from the attack. See FM 6-30.

collateral damage distance – Minimum distance in meters that a desired ground zero for a nuclear explosion must be separated from civilian personnel and materiel to ensure with 99 percent assurance that a 5 percent incidence of injuries or property damage will not be exceeded. (FM 100-30)

collecting – An activity of information management: the continuous acquisition of relevant information by any means, including direct observation, other organic resources, or other official, unofficial, or public sources from the information environment. (FM 6-0)

collection plan – (DOD, NATO) A plan for collecting information from all available sources to meet intelligence requirements and for transforming those requirements into orders and requests to appropriate agencies. [Note: the Army term is “intelligence, surveillance, and reconnaissance (ISR) plan.”] See also **combat intelligence**; **information**; **information requirements**; **intelligence cycle**; **reconnaissance**. See FM 34-1.

collection point – (DOD) A point designated for the assembly of personnel casualties, stragglers, disabled materiel, salvage, etc. for further movement to collecting stations or rear installations. (Army/Marine Corps) A point designated for the assembly of casualties, stragglers, not operationally ready equipment and materiel, salvage, prisoners, and so on for treatment, classification, sorting, repair, or further movement to collecting stations or rear facilities and installations. See also **aid station**. (FM 8-10-6) (See page 7-62 for symbols.)

column formation – (DOD, NATO) A formation in which elements are placed one behind the other. See also **box formation**; **diamond formation**; **echelon formation**; **formation**; **line formation**; **movement formation**; **vee formation**; **wedge formation**. See FM 3-90.

combat and operational stress control – A coordinated program for the prevention, triage, and treatment of each echelon of battle fatigue to maximize rapid return to duty and minimize misconduct stress reactions and post-traumatic stress disorders. This program is conducted by unit mental health personnel plus echelon above division combat stress control units. Also called **COSC**. (FM 8-51)

combatant command – (DOD) A unified or specified command with a broad continuing mission under a single commander established and so designated by the President through the Secretary of Defense and with the advice and assistance of the Chairman of the Joint Chiefs of Staff. Combatant commands typically have geographic or functional responsibilities. See FM 3-0.

combatant command (command authority) – (DOD) Nontransferable command authority established by Title 10 (“Armed Forces”), United States Code, Section 164, exercised only by commanders of unified or specified combatant commands unless otherwise directed by the President or Secretary of Defense. Combatant command (command authority) cannot be delegated and is the authority of a combatant commander to perform those functions of command over assigned forces involving organizing and employing commands and forces, assigning tasks, designating objectives, and giving authoritative direction over all aspects of military operations, joint training, and logistics necessary to accomplish the missions assigned to the command. Combatant command (command authority) should be exercised through the commanders of subordinate organizations. Normally this authority is exercised through subordinate joint force commanders and Service and/or functional component commanders. Combatant command (command authority) provides full authority to organize and employ commands and forces as the combatant commander considers necessary to accomplish assigned missions. Operational control is inherent in combatant command (command authority). See also **combatant command; operational control; tactical control**. Also called **COCOM**. See FM 3-0.

combat arms – Units and soldiers who close with the enemy and destroy enemy forces or provide firepower and destructive capabilities on the battlefield. (FM 3-90)

combat assessment – (DOD) The determination of the overall effectiveness of force employment during military operations. Combat assessment is composed of three major components: a. battle damage assessment; b. munitions effects assessment; and c. reattack recommendation. See also **battle damage assessment; course of action; wargaming**. See FM 6-0.

combat configured load – A planned package of ammunition or other supplies that is transported as a single load to support a type of unit or weapon system. Also called **CCL**. (FM 4-30.13)

combat control team – (DOD) A small task organized team of Air Force parachute and combat diver qualified personnel trained and equipped to rapidly establish and control drop, landing, and extraction zone air traffic in austere or hostile conditions. They survey and establish terminal airheads as well as provide guidance to aircraft for airlift operations. They provide command and control, conduct reconnaissance and surveillance, and survey assessments of potential objective airfields or assault zones. They can also perform limited weather observations and removal of obstacles or unexploded ordnance with demolitions. See FM 90-26. (Marine Corps) Personnel organized, trained, and equipped to establish and operate navigation or terminal guidance aids, communications, and aircraft control facilities within the objective area. Also called **CCT**. See also **airborne; landing zone**.

combat effectiveness – The ability of a unit to perform its mission. Factors such as ammunition, personnel, status of fuel, and weapon systems are assessed and rated. (FM 101-5)

combat formation – An ordered arrangement of forces for a specific purpose and the general configuration of a unit on the ground. (FM 3-90)

combat information – (DOD) Unevaluated data, gathered by or provided directly to the tactical commander which, due to its highly perishable nature or the criticality of the situation, cannot be processed into tactical intelligence in time to satisfy the user's tactical intelligence requirements. See also **information**. See FM 6-0.

combat intelligence – (DOD) That knowledge of the enemy, weather, and geographical features required by a commander in the planning and conduct of combat operations. See FM 34-1.

combat load – The minimum mission-essential equipment, as determined by the commander responsible for carrying out the mission, required for soldiers to fight and survive immediate combat operations. (FM 10-1)

combat loading – (DOD, NATO) The arrangement of personnel and the stowage of equipment and supplies in a manner designed to conform to the anticipated tactical operation of the organization embarked. Each individual item is stowed so that it can be unloaded at the required time. See also **loading plan**. See FM 55-1.

combat observation and lasing team – A fire support team controlled at the brigade level that is capable of target acquisition under reduced visibility conditions and has both laser-rangefinding and laser-designating capabilities. Also called **COLT**. See also **call for fire**. (FM 6-20-40)

combat outpost – (Army) A reinforced observation post capable of conducting limited combat operations. See also **counterreconnaissance**. (FM 3-90) (Marine Corps) A security force established at the regimental level during defensive or stationary operations. (See page 7-26 for symbol.)

combat patrol – (NATO) For ground forces, a tactical unit sent out from the main body to engage in independent fighting; detachment assigned to protect the front, flank, or rear of the main body by fighting if necessary. Also called **fighting patrol**. See also **ambush**; **raid**; **security operations**. See FM 7-10.

combat power – (DOD, NATO) The total means of destructive and/or disruptive force which a military unit/formation can apply against the opponent at a given time. See FM 3-0.

combat ready – (NATO) 1. As applied to organizations or equipment: available for combat operations. 2. As applied to personnel: qualified to carry out combat operations in the unit to which they are assigned.

combat repair team – Provides the first line of maintenance support to armor and infantry companies. The combat repair team (CRT) is a modular organization that provides dedicated and habitual support to the same unit both in a garrison and a tactical environment. As the task organization changes, a CRT moves with its supported unit. Also called **CRT**. (FM 4-30.3)

combat search and rescue – (DOD) A specific task performed by rescue forces to effect the recovery of distressed personnel during war or military operations other than war. Also called **CSAR**. See FM 100-25.

combat service support – (DOD) The essential capabilities, functions, activities, and tasks necessary to sustain all elements of operating forces in theater at all levels of war. Within the national and theater logistic systems, it includes but is not limited to that support rendered by service forces in ensuring the aspects of supply, maintenance, transportation, health services, and other services required by aviation and ground combat troops to permit those units to accomplish their missions in combat. Combat service support encompasses those activities at all levels of war that produce sustainment to all operating forces on the battlefield. Also called **CSS**. See also **combat support**. See FM 4-0. (See page 5-20 for symbol.)

combat service support battlefield operating system – (Army) The support and service to sustain forces during full spectrum operations. See also **battlefield operating system**. (FM 7-15)

combat service support element – (Marine Corps) The core element of a Marine air-ground task force (MAGTF) that is task-organized to provide the combat service support necessary to accomplish the MAGTF's mission. The combat service support element varies in size from a small detachment to one or more force service support groups. It provides supply, maintenance, transportation, general engineering, health services, and a variety of other services to the MAGTF. In a joint or multinational environment, it may also contain other Service or multinational forces assigned or attached to the MAGTF. The combat service support element itself is not a formal command. Also called **CSSE**. See also **aviation combat element; command element; ground combat element; Marine air-ground task force; Marine expeditionary force; Marine expeditionary force (forward); Marine expeditionary unit; special purpose Marine air-ground task force; task force**.

combat service support reach operations – The operational positioning and efficient use of all available CSS assets and capabilities, from the industrial base to the soldier in the field. Also called **CSS reach operations**. (FM 3-0)

combat stress – The mental, emotional, or physical tension, strain, or distress resulting from exposure to combat-related conditions. (FM 6-22.5)

combat support – (DOD, NATO) Fire support and operational assistance provided to combat elements. (Army) Critical combat functions provided by units and soldiers in conjunction with combat arms units and soldiers to secure victory. Also called **CS**. (FM 3-90) (See page 5-15 for symbol.)

combatting terrorism – (DOD) Actions, including antiterrorism (defensive measures taken to reduce vulnerability to terrorist acts) and counterterrorism (offensive measures taken to prevent, deter, and respond to terrorism), taken to oppose terrorism throughout the entire threat spectrum. Also called **CBT**. See also **antiterrorism; counterterrorism; stability operations**. See FM 3-07.

combat trains – The portion of unit trains that provides the combat service support required for immediate response to the needs of the forward tactical elements. At company level, medical recovery, supply, and maintenance elements normally constitute the combat trains. At

battalion, the combat trains normally consist of ammunition and petroleum, oils, and lubricants (POL) vehicles; maintenance and recovery vehicles and crews; and the battalion aid station. See also **collection point; field trains; unit trains**. (FM 7-30)

combat trains command post – Consists of the task force S-4 and representatives from the S-1. It plans and coordinates sustainment for tactical operations and serves as the alternate for the main command post. Also called **CTCP**. See also **alternate command post; brigade support area; collection point; combat trains; field trains; unit trains**. (FM 7-30). (See page 5-39 for symbol.)

combat zone – (DOD, NATO) 1. That area required by combat forces for the conduct of operations. 2. The territory forward of the Army rear area boundary. [Note: the NATO definition adds: “It is divided into: a. the forward combat zone, comprising the territory forward of the corps rear boundary; and b. the rear combat zone, usually comprising the territory between the corps rear boundary and the army group rear boundary.”] Also called **CZ**. See also **communications zone**. See FM 3-0.

combined arms – (Army) The synchronized or simultaneous application of several arms—such as infantry, armor, field artillery, engineers, air defense, and aviation—to achieve an effect on the enemy that is greater than if each arm were used against the enemy in sequence. (FM 3-0) (Marine Corps) 1. The full integration of combat arms in such a way that to counteract one, the enemy must become more vulnerable to another. 2. The tactics, techniques, and procedures employed by a force to integrate firepower and mobility to produce a desired effect upon the enemy. See also **task force**.

combined arms team – (DOD) The full integration and application of two or more arms or elements of one Military Service into an operation. (Army) Two or more arms mutually supporting one another, usually consisting of infantry, armor, cavalry, aviation, field artillery, air defense artillery, and engineers. See also **joint operations; task force**. (FM 3-90).

command – 1. (DOD only) The authority that a commander in the Armed Forces lawfully exercises over subordinates by virtue of rank or assignment. Command includes the authority and responsibility for effectively using available resources for planning the employment of, organizing, directing, coordinating, and controlling military forces for the accomplishment of assigned missions. It also includes responsibility for health, welfare, morale, and discipline of assigned personnel. See FM 6-0. (DOD, NATO) 2. An order given by a commander; that is, the will of the commander expressed for the purpose of bringing about a particular action. See FM 6-0. 3. A unit or units, an organization, or an area under the command of one individual. See FM 6-0. (NATO only) To dominate by a field of weapon fire or by observation from a superior position. See also **battle command; commander**.

command and control – (DOD) The exercise of authority and direction by a properly designated commander over assigned and attached forces in the accomplishment of the mission. Command and control functions are performed through an arrangement of personnel, equipment, communications, facilities, and procedures employed by a commander in planning, directing, coordinating, and controlling forces and operations in the accomplishment of the mission. (Army) The exercise of authority and direction by a properly designated commander over assigned and attached forces in the accomplishment of a mission. Commanders perform command and control functions through a command and control system. (FM 6-0) (Marine Corps) In Marine Corps usage, the means by which a commander recognizes what needs to be done and sees to it that appropriate actions are

taken. Also called **C2**. See also **battle command; command; command and control system; commander; command post; control**.

command and control battlefield operating system – (Army) All collective tasks associated with supporting the exercise of authority and direction by a properly designated commander over assigned and available forces in the accomplishment of the mission. See also **battlefield operating system**. (FM 7-15)

command and control system – (DOD) The facilities, equipment, communications, procedures, and personnel essential to a commander for planning, directing, and controlling operations of assigned forces pursuant to the missions assigned. (Army) The arrangement of personnel, information management, procedures, and equipment and facilities essential for the commander to conduct operations. Also called **C2 system**. (FM 6-0)

command channel – See **chain of command**.

command element – (Marine Corps) The core element of a Marine air-ground task force (MAGTF) that is the headquarters. The command element is composed of the commander, general or executive and special staff sections, headquarters section, and requisite communications support, intelligence, and reconnaissance forces necessary to accomplish the MAGTF's mission. The command element provides command and control, intelligence, and other support essential for effective planning and execution of operations by the other elements of the MAGTF. The command element varies in size and composition and in a joint or multinational environment, it may contain other Service or multinational forces assigned or attached to the MAGTF. Also called **CE**. See also **aviation combat element; combat service support element; ground combat element; Marine air-ground task force; Marine expeditionary force; Marine expeditionary force (forward); Marine expeditionary unit; special purpose Marine air-ground task force; task force**.

commander – (Army) One who is in command because of rank, position, or other circumstances. (FM 6-0) (Marine Corps) One who is properly appointed to command an organization, or who under applicable provisions of law, regulations, or orders succeeds to such command due to transfer, incapacity, death, or absence of the previous commanding officer. Marine Corps commanders are titled as Commandant, Commander, Commanding General, Commanding Officer, Director, Inspector-Instructor. Other titles used to designate Marine Corps commanders shall be made only with the specific approval of the Commandant of the Marine Corps. The titles Officer in Charge and Noncommissioned Officer in Charge do not normally denote a commander. However, in specific instances, superiors in the chain of command may delegate command authority to officers in charge or noncommissioned officers in charge to the extent required for them to carry out their assigned tasks. See also **battle command; command**.

commander's concept – See **concept of operations**.

commander's critical information requirements – (DOD) A comprehensive list of information requirements identified by the commander as being critical in facilitating timely information management and the decisionmaking process that affect successful mission accomplishment. The two key subcomponents are critical friendly force information and priority intelligence requirements. (Army) – Elements of information required by commanders that directly affect decisionmaking and dictate the successful execution of military operations. (FM 3-0) (Marine Corps) Information regarding the enemy and friendly activities and the environment identified by the commander as critical to maintaining

situational awareness, planning future activities, and facilitating timely decisionmaking. [Note: in Marine Corps usage, commander's critical information requirements are normally divided into three primary subcategories: priority intelligence requirements, friendly force information requirements, and essential elements of friendly information.] Also called **CCIR**. See also **essential elements of friendly information; information; intelligence; priority intelligence requirements**.

commander's intent – (DOD) A concise expression of the purpose of the operation and the desired end state that serves as the initial impetus for the planning process. It may also include the commander's assessment of the adversary commander's intent and an assessment of where and how much risk is acceptable during the operation. (Army) A clear, concise statement of what the force must do and the conditions the force must meet to succeed with respect to the enemy, terrain, and desired end state. (FM 3-0) (Marine Corps) A commander's clear, concise articulation of the purpose(s) behind one or more tasks assigned to a subordinate. It is one of two parts of every mission statement which guides the exercise of initiative in the absence of instructions.

commander's visualization – (Army) The mental process of achieving a clear understanding of the force's current state with relation to the enemy and environment (situational understanding), and developing a desired end state which represents mission accomplishment and the key tasks that move the force from its current state to the end state (commander's intent). See also **commander's intent; situational understanding**. (FM 6-0)

command group – Consists of the commander and a METT-TC derived small group from the staff that accompanies the commander throughout the area of operations (AO) and enables him to exercise command and control away from a command post. [Note: the Marine Corps uses METT-T.] The command group is organized and equipped to suit the commander's decisionmaking and leadership requirements while ensuring he possesses the ability to accomplish critical command and control functions anywhere in the AO. The command group consists of critical staff officers necessary to assist the commander in directly influencing the ongoing operation, and normally provides local security and other personal assistance for the commander as required. See also **command post**.

command post – (DOD, NATO) A unit's or subunit's headquarters where the commander and the staff perform their activities. [Note: the Army definition ends here.] In combat, a unit's or subunit's headquarters is often divided into echelons; the echelon in which the unit or subunit commander is located or from which such commander operates is called a command post. Also called **CP**. See also **alternate command post; assault command post; base defense operations center; combat trains command post; command group; main command post; rear command post; tactical command post; tactical operations center**. See FM 6-0. (See page 5-39 for symbol.)

command post exercise – (DOD, NATO) An exercise in which the forces are simulated, involving the commander, the staff, and communications within and between headquarters. Also called **CPX**. See also **exercise; maneuver**. See FM 7-0.

command relationships – (DOD) The interrelated responsibilities between commanders, as well as the operational authority exercised by commanders in the chain of command; defined further as combatant command (command authority), operational control, tactical control, or support. See also **administrative control; assign; attach; chain of command;**

combatant command (command authority); command; direct support; general support; operational control; support; tactical control. See FM 3-0.

committed force – A force in contact with an enemy or deployed on a specific mission or course of action which precludes its employment elsewhere. See also **attack; decisive engagement.** (FM 3-90)

common operational picture – (DOD) A single identical display of relevant information shared by more than one command. A common operational picture facilitates collaborative planning and assists all echelons to achieve situational awareness. (Army) An operational picture tailored to the user's requirements, based on common data and information shared by more than one command. Also called **COP.** (FM 3-0)

common servicing – (DOD) The function performed by one Military Service in support of another Military Service for which reimbursement is not required from the Service receiving support. See also **command relationship; support.** See FM 10-1.

common use – (DOD) Services, materials, or facilities provided by a Department of Defense agency or a Military Department on a common basis for two or more Department of Defense agencies, elements, or other organizations as directed. See FM 10-1.

communication deception – (DOD) Use of devices, operations, and techniques with the intent of confusing or misleading the user of a communications link or a navigation system. See also **deception; electronic warfare; imitative electronic deception.** See FM 34-1.

communications checkpoint – An air control point that requires serial leaders to report either to the aviation mission commander or the terminal control facility. See also **air control point; air corridor; Army airspace command and control.** (FM 3-52) (See page 7-22 for symbol.)

communications intelligence – (DOD) Technical information and intelligence derived from foreign communications by other than the intended recipients. Also called **COMINT.** See also **combat intelligence.** See FM 34-1.

communications jamming – Electronic measures taken to deny the enemy use of communications means See also **barrage jamming; electronic warfare; information operations; jamming.** (FM 34-1)

communications security – (DOD) The protection resulting from all measures designed to deny unauthorized persons information of value that might be derived from the possession and study of telecommunications, or to mislead unauthorized persons in their interpretation of the results of such possession and study. Communications security includes: cryptosecurity, transmission security, emission security, and physical security of communications security materials and information. a. **cryptosecurity**—The component of communications security that results from the provision of technically sound cryptosystems and their proper use. b. **transmission security**—The component of communications security that results from all measures designed to protect transmissions from interception and exploitation by means other than cryptanalysis. c. **emission security**—The component of communications security that results from all measures taken to deny unauthorized persons information of value that might be derived from intercept and analysis of compromising emanations from crypto-equipment and telecommunications systems. d. **physical security**—The component of communications security that results from all physical measures necessary to safeguard classified equipment, material, and documents

from access thereto or observation thereof by unauthorized persons. Also called **COMSEC**. See FM 34-1.

communications zone – (DOD, NATO) Rear part of a theater of war or theater of operations (behind but contiguous to the combat zone) which contains the lines of communications, establishments for supply and evacuation, and other agencies required for the immediate support and maintenance of the field forces. [Note: the NATO term is communication zone.] Also called **COMMZ**. See also **combat zone**; **line of communications**; **rear area**. See FM 100-7.

company – A unit consisting of two or more platoons, usually of the same type, with a headquarters and a limited capacity for self-support. (FM 3-90) (See page 5-33 for symbol.)

company maintenance team – A team organized and equipped to provide mobile organizational maintenance support to the combat companies. Company maintenance teams perform battle damage assessment and battle damage repair, diagnose maintenance problems, and conduct organizational repairs and recovery. Also called **CMT**. (FM 4-30.3)

company team – A combined arms organization formed by attaching one or more nonorganic tank, mechanized infantry, or light infantry platoons to a tank, mechanized infantry, or light infantry company either in exchange for or in addition to organic platoons. See also **combined arms team**. (FM 3-90)

compartmentation – (DOD) 1. Establishment and management of an organization so that information about the personnel, internal organization, or activities of one component is made available to any other component only to the extent required for the performance of assigned duties. See FM 31-20-5. 2. Effects of relief and drainage upon avenues of approach so as to produce areas bounded on at least two sides by terrain features such as woods, ridges, or ravines that limit observation or observed fire into the area from points outside the area. (Army) 1. In unconventional warfare, the division of an organization or activity into functional segments or cells to restrict communication between them and prevent knowledge of the identity or activities of other segments except on a need-to-know basis. (FM 31-20-5) 2. Restricting the use of cryptovariabes to specific users for the purpose of limiting access to the information protected by these cryptovariabes and limiting the adverse impact of a compromise of these variables. (FM 31-20-5).

compass direction – (NATO) The horizontal direction expressed as an angular distance measured clockwise from compass north.

complete round – (DOD) A term applied to an assemblage of explosive and nonexplosive components designed to perform a specific function at the time and under the conditions desired. Examples of complete rounds of ammunition are: a. separate loading, consisting of a primer, propelling charge, and, except for blank ammunition, a projectile and a fuze; b. fixed or semifixed, consisting of a primer, propelling charge, cartridge case, a projectile, and, except when solid projectiles are used, a fuze; c. bomb, consisting of all component parts required to drop and function the bomb once; d. missile, consisting of a complete warhead section and a missile body with its associated components and propellants; and e. rocket, consisting of all components necessary to function. See FM 6-20-40.

compromise (DOD) – The known or suspected exposure of clandestine personnel, installations, or other assets, or classified information or material, to an unauthorized person. See FM 3-05.20.

computed air release point – (DOD, NATO) A computed air position where the first paratroop or cargo item is released to land on a specified impact point. Also called **CARP**. See FM 90-26.

computer network attack – (DOD) Operations to disrupt, deny, degrade, or destroy information resident in computers and computer networks, or the computers and networks themselves. Electronic attack (EA) can be used against a computer, but it is not computer network attack (CNA). CNA relies on the data stream to execute the attack while EA relies on the electromagnetic spectrum. An example of the two operations is the following: sending a code or instruction to a central processing unit that causes the computer to short out the power supply is CNA. Using an electromagnetic pulse device to destroy a computer's electronics and causing the same result is EA. Also called **CNA**. See FM 3-13.

computer network defense – (DOD) Defensive measures to protect and defend information, computers, and networks from disruption, denial, degradation, or destruction. Also called **CND**. See FM 3-13.

computer network exploitation – Enabling operations and intelligence collection to gather data from target or adversary automated information systems or networks. (FM 3-13)

computer security – (DOD) The protection resulting from all measures to deny unauthorized access and exploitation of friendly computer systems. Also called **COMPUSEC**. See FM 3-13.

concealment – (DOD, NATO) The protection from observation or surveillance. See FM 7-10.

concept of operations – (DOD) A verbal or graphic statement, in broad outline, of a commander's assumptions or intent in regard to an operation or series of operations. The concept of operations frequently is embodied in campaign plans and operation plans; in the latter case, particularly when the plans cover a series of connected operations to be carried out simultaneously or in succession. The concept is designed to give an overall picture of the operation. It is included primarily for additional clarity of purpose. (NATO) A clear and concise statement of the line of action chosen by a commander in order to accomplish his mission. (Army) How commanders see the actions of subordinate units fitting together to accomplish the mission. As a minimum, the description includes the scheme of maneuver and concept of fires. The concept of operations expands the commander's selected course of action and expresses how each element of the force will cooperate to accomplish the mission. Also called **CONOPS**. (FM 3-0)

concept plan – (DOD) An operation plan in concept format. Also called **CONPLAN**. See also **operation plan**. See FM 101-5.

conduct – To perform the activities of the operations process: planning, preparing, executing, and continuously assessing. (FM 6-0)

cone of fire – The pattern formed on the way to the target by several rounds fired in a burst. See also **beaten zone**. (FM 3-22.68)

configured load – Single or multicommodity load of supplies built to the anticipated or actual needs of a consuming unit, thereby facilitating throughput to the lowest possible echelon. Configured loads leverage the efficiencies of containerization and capabilities of containerized roll on/roll off platforms whenever possible. The two types of configured loads are mission configured loads and unit configured loads. See also **mission configured load**; **unit configured load**. (FM 4-0)

confirmation brief – A briefing subordinate leaders give to the higher commander immediately after the operation order is given. It is their understanding of his intent, their specific tasks, and the relationship between their mission and the other units in the operation. (FM 101-5)

conflict – (DOD) An armed struggle or clash between organized groups within a nation or between nations in order to achieve limited political or military objectives. Although regular forces are often involved, irregular forces frequently predominate. Conflict is often protracted, confined to a restricted geographic area, and constrained in weaponry and level of violence. Within this state, military power in response to threats may be exercised in an indirect manner while supportive of other instruments of national power. Limited objectives may be achieved by the short, focused, and direct application of force. See FM 100-8.

conflict termination – The point at which the principal means of conflict shifts from the use or threat of force to other means of persuasion. (FM 3-0)

consolidation – See **consolidation of position**.

consolidation of position – (DOD, NATO) Organizing and strengthening a newly captured position so that it can be used against the enemy. [Note: the Army uses the term “consolidation.”] See FM 3-90.

consolidation psychological operation – Psychological operations conducted in foreign areas inhabited by an enemy or potentially hostile populace and occupied by US forces or in which US forces are based, designed to produce behaviors by the foreign populace that support United States objectives in the area. (FM 3-05.30)

constraint – (Army) A restriction placed on the command by a higher command. A constraint dictates an action or inaction, thus restricting the freedom of action a subordinate commander has for planning. (FM 101-5) (Marine Corps) Something which must be done that limits freedom of action. See also **restraint**.

consumption rate – (DOD, NATO) The average quantity of an item consumed or expended during a given time interval, expressed in quantities by the most appropriate unit of measurement per applicable stated basis. See FM 10-1.

contact – (DOD) 1. In air intercept, a term meaning “Unit has an unevaluated target.” See FM 44-100. 2. In health services, an unevaluated individual who is known to have been sufficiently near an infected individual to have been exposed to the transfer of infectious material. See FM 4-02.

contact point – (DOD, NATO) 1. In land warfare, a point on the terrain, easily identifiable, where two or more ground units are required to make physical contact. See FM 3-90. 2. In air operations, the position at which a mission leader makes radio contact with an air control agency. See FM 3-04.111. 3. (DOD only) In evasion and recovery operations, a location where an evader can establish contact with friendly forces. See FM 100-25. Also called **CP**. See also **checkpoint; control point; coordinating point**. (See page 7-41 for symbol.)

contain – (DOD, NATO) To stop, hold, or surround the forces of the enemy or to cause the enemy to center activity on a given front and to prevent the withdrawal of any part of the enemy’s force for use elsewhere. See also **block; fix; suppress**. See FM 3-90. (See page A-2 for symbol.)

container delivery system – A system for aerial delivery of supplies and small items of equipment from low or high altitudes into a small area. Also called **CDS**. See also **bulk cargo**. (FM 4-01.30)

contamination – (DOD, NATO) 1. The deposit, absorption, or adsorption of radioactive material, or of biological or chemical agents on or by structures, areas, personnel, or objects. 2. (DOD only) Food and/or water made unfit for consumption by humans or animals because of the presence of environmental chemicals, radioactive elements, bacteria, or organisms, the byproduct of the growth of bacteria or organisms, the decomposing material (to include the food substance itself), or waste in the food or water. See also **decontamination; fallout; induced radiation; residual radiation**. See FM 3-11.

contiguous area of operations – When all of a commander's subordinate forces' areas of operation share one or more common boundaries. (FM 3-90)

contingency – (DOD) An emergency involving military forces caused by natural disasters, terrorists, subversives, or by required military operations. Due to the uncertainty of the situation, contingencies require plans, rapid response, and special procedures to ensure the safety and readiness of personnel, installations, and equipment. See also **branch; concept plan; operation order; operation plan; sequel**. See FM 101-5.

contingency plan – (DOD) A plan for major contingencies that can reasonably be anticipated in the principal geographic subareas of the command. See FM 101-5.

contour flight – Flight characterized by constant airspeed and varying altitude as dictated by vegetation, obstacles, and ambient light. See also **terrain flight**. (FM 3-04.111)

contractor – Person or business that provides products or services for monetary compensation. A contractor furnishes supplies, services, or performs work at a certain price or rate based on the terms of a contract. (FM 3-100.21)

control – (DOD) 1. Authority that may be less than full command exercised by a commander over part of the activities of subordinate or other organizations. See FM 3-0. 2. In mapping, charting, and photogrammetry, a collective term for a system of marks or objects on the Earth or on a map or a photograph, whose positions or elevations (or both) have been or will be determined. See FM 3-25.26. 3. Physical or psychological pressures exerted with the intent to assure that an agent or group will respond as directed. 4. An indicator governing the distribution and use of documents, information, or material. Such indicators are the subject of intelligence community agreement and are specially defined in appropriate regulations. See FM 34-1. (Army) 1. Within command and control, the regulation of forces and other battlefield operating systems to accomplish the mission in accordance with the commander's intent. It includes collecting, processing, displaying, storing, and disseminating relevant information for creating the common operational picture and using information during the operations process. (FM 6-0) 2. A tactical mission task that requires the commander to maintain physical influence over a specified area to prevent its use by an enemy. (FM 3-90) 3. Action taken that eliminates a hazard or reduces the risk from that hazard. Part of the third step in risk management. (FM 100-14) See also **administrative control; command relationship; operational control; tactical control**.

controlled airspace – (DOD, NATO) An airspace of defined dimensions within which air traffic control service is provided to controlled flights. See also **airspace coordination area; area**

of operations; Army airspace command and control; restricted operations area/zone. See FM 3-52.

controlled exchange – The removal of serviceable parts, components, or assemblies from unserviceable, economically repairable equipment and their immediate reuse in restoring a like item of equipment to a combat operable or serviceable condition. See also **cannibalize**. (FM 4-30.3)

controlled item – See **regulated item**.

controlled supply rate – The rate of ammunition consumption that can be supported, considering availability, facilities, and transportation. It is expressed in rounds per unit, individual, or vehicle per day. The Army service component commander announces the controlled supply rate (CSR) for each item of ammunition, and, in turn, the commander of each subordinate tactical unit announces a CSR to his commanders at the next lower levels. A unit may not draw ammunition in excess of its CSR without authority from its next higher headquarters. Also called **CSR**. See also **one day's supply; required supply rate**. (FM 9-6)

control measures – Directives given graphically or orally by a commander to subordinate commands to assign responsibilities, coordinate fires and maneuver, and control combat operations. Each control measure can be portrayed graphically. In general, all control measures should be easily identifiable on the ground. (FM 101-5)

control point – (DOD, NATO) 1. A position along a route of march at which men are stationed to give information and instructions for the regulation of supply or traffic. See FM 3-19.1. 2. A position marked by a buoy, boat, aircraft, electronic device, conspicuous terrain feature, or other identifiable object which is given a name or number and used as an aid to navigation or control of ships, boats, or aircraft. 3. In making mosaics, a point located by ground survey with which a corresponding point on a photograph is matched as a check. See FM 3-34.331.

controls – Actions to eliminate threats or reduce their risk. (FM 100-14)

converged sheaf – (DOD) The lateral distribution of fire of two or more pieces so that the planes of fire intersect at a given point. See also **final protective fire; sheaf**. See FM 6-30.

convoy – (DOD, NATO) 1. A number of merchant ships and/or naval auxiliaries usually escorted by warships and/or aircraft—or a single merchant ship or naval auxiliary under surface escort—assembled and organized for the purpose of passage together. 2. A group of vehicles organized for the purpose of control and orderly movement with or without escort protection that moves over the same route at the same time under one commander. [Note: the NATO definition does not include “that moves over the same route at the same time under one commander.”] See also **march column**. See FM 4-01.30. (See page 7-68 for symbols.)

convoy security operations – A specialized kind of area security operations conducted to protect convoys. (FM 3-90)

coordinated fire line – (DOD, NATO) The coordinated fire line (CFL) is a line beyond which conventional, indirect, surface fire support means may fire at any time within the boundaries of the establishing headquarters without additional coordination. The purpose of the CFL is to expedite the surface-to-surface attack of targets beyond the CFL without coordination with the ground commander in whose area the targets are located. Also called **CFL**. See also **fire support**. See FM 6-30. (See page 7-36 for symbol.)

coordinating altitude – (DOD) A procedural airspace control method to separate fixed- and rotary-wing aircraft by determining an altitude below which fixed-wing aircraft will normally not fly and above which rotary-wing aircraft normally will not fly. The coordinating altitude is normally specified in the airspace control plan and may include a buffer zone for small altitude deviations. See also **above ground level; controlled airspace**. See FM 3-52.

coordination – The action necessary to ensure adequately integrated relationships between separate organizations located in the same area. Coordination may include such matters as fire support, emergency defense measures, area intelligence, and other situations in which coordination is considered necessary. (FM 6-0)

corduroy road – A road made or reinforced by laying logs or planks perpendicular to the direction of travel. It is usually used when a road is muddy, snow packed, or in a swamp. (FM 5-34)

corps – The Army's largest tactical unit and the instrument by which higher echelons of command conduct maneuver at the operational level. (FM 3-90) (See page 5-33 for symbol.)

correct – A procedure word meaning, "You are correct, or what you have transmitted is correct." See also **procedure word**. (FM 24-19)

correction – A procedure word meaning, 1. "An error has been made in this transmission. Transmission will continue with the last word correctly transmitted. 2. "An error has been made in this transmission (or message indicated). The correct version is (insert text)." 3. "That which follows is a corrected version in answer to your request for verification." See also **procedure word**. (FM 24-19)

corrosivity – One of the four possible characteristics of hazardous wastes defined by the Environmental Protection Agency. It is the ability to corrode other materials. (FM 3-100.4)

counterair – (DOD) A mission that integrates offensive and defensive operations to attain and maintain a desired degree of air superiority. Counterair missions are designed to destroy or negate enemy aircraft and missiles, both before and after launch. See also **air superiority; defensive counterair; offensive counterair**. See FM 44-100.

counterattack – (DOD, NATO) Attack by part or all of a defending force against an enemy attacking force, for such specific purposes as regaining ground lost, or cutting off or destroying enemy advance units, and with the general objective of denying to the enemy the attainment of the enemy's purpose in attacking. In sustained defensive operations, it is undertaken to restore the battle position and is directed at limited objectives. See also **attack**. See FM 3-0. (See page A-3 for symbol.)

counterdeception – (DOD) Efforts to negate, neutralize, diminish the effects of, or gain the advantage from a foreign deception operation. Counterdeception does not include the intelligence function of identifying foreign deception operations. See also **deception**. See FM 3-13.

counterdrug – (DOD) Those active measures taken to detect, monitor, and counter the production, trafficking, and use of illegal drugs. See FM 3-07.

counterfire – (DOD, NATO) Fire intended to destroy or neutralize enemy weapons. Includes counterbattery, counterbombardment, and countermortar fire. [Note: the NATO definition does not include the second sentence.] See also **fire; fire mission**. See FM 6-20-30.

counterinsurgency – (DOD) Those military, paramilitary, political, economic, psychological, and civic actions taken by a government to defeat insurgency. See also **insurgency**; **stability operations**; **support operations**. See FM 3-07.

counterintelligence – (DOD) Information gathered and activities conducted to protect against espionage, other intelligence activities, sabotage, or assassinations conducted by or on behalf of foreign governments or elements thereof, foreign organizations, or foreign persons, or international terrorist activities. See FM 3-13. (Marine Corps) Within the Marine Corps, counterintelligence constitutes active and passive measures intended to deny a threat force valuable information about the friendly situation, to detect and neutralize hostile intelligence collection, and to deceive the enemy as to friendly capabilities and intentions. Also called **CI**.

counterintelligence coordinating authority – Subordinate to the staff intelligence officer or an element of the J/G/S2X specifically tasked with the oversight, deconfliction, and coordination of that unit's counterintelligence activities. When constituted as the senior or sole counterintelligence coordinating authority within a task force, it is known as the Task Force Counterintelligence Coordinating Authority (TFCICA). Also called **CICA**. (FM 34-60)

counterintelligence measures – Those activities conducted or enacted by a unit or organization to counter the actual or potential capabilities and activities of foreign intelligence and security services and the intelligence activities of non-state entities, such as organized crime, terrorist groups, and drug traffickers. (FM 34-60)

counterintelligence operations – (DOD) Proactive activities designed to identify, exploit, neutralize, or deter foreign intelligence collection and terrorist activities directed against the Department of Defense (DOD). Operations are conducted to: manipulate, disrupt, neutralize, and/or destroy the effectiveness of foreign intelligence activities; recruit or induce defection of foreign intelligence officers and personnel; collect threat information on foreign intelligence operations, modus operandi, intelligence requirements, targeting, objectives, personalities, communications, capabilities, limitations, and vulnerabilities; provide information and operations databases to support decision makers; provide counterintelligence (CI) support to clandestine human intelligence operations; identify post, ongoing, or planned espionage; support force protection, operations other than war, and peacekeeping; acquire foreign intelligence espionage equipment for analysis and countermeasures development; develop operational data, threat data, and espionage leads for future CI operations, investigations, and projects and develop the potential of these leads to enhance DOD security overall; and support specific Chairman of the Joint Chiefs of Staff, DOD, and national plans. (Army) Those activities designed to detect and counter capabilities and activities of foreign intelligence and security services and the intelligence activities of non-state entities, such as organized crime, terrorist groups, and drug traffickers. Counterintelligence operations include, but are not limited to, investigations, collection, support to counterreconnaissance, support to deception, support to information and operations security, and support to force protection. (FM 34-60)

countermeasures – (DOD) That form of military science that, by employment of devices and/or techniques, has as its objective the impairment of the operational effectiveness of enemy activity. See also **electronic warfare**; **risk management**. See FM 20-3.

countermine – (DOD, NATO) To explode the main charge in a mine by the shock of a nearby explosion of another mine or independent explosive charge. The explosion of the main charge may be caused either by sympathetic detonation or through the explosive train and/or firing

mechanisms of that mine. (Army) The actions taken to detect, bypass, breach, mark, report, record, and eliminate enemy mines or minefields. See also **breach**. (FM 20-32)

countermobility – A component of combat engineering and one of the five engineer battlefield functions. It augments natural terrain with obstacle systems according to the commander's concept. This adds depth to the battle in space and time by attacking the enemy's ability to maneuver his forces. (FM 5-100)

countermobility operations – (DOD) The construction of obstacles and emplacement of minefields to delay, disrupt, and destroy the enemy by reinforcement of the terrain. The primary purpose of countermobility operations is to slow or divert the enemy, to increase time for target acquisition, and to increase weapon effectiveness. See FM 5-100.

counterpreparation fire – (DOD, NATO) Intensive prearranged fire delivered when the imminence of the enemy attack is discovered. It is designed to: break up enemy formations; disorganize the enemy's system of command, communications, and observation; decrease the effectiveness of artillery preparation; and impair the enemy's offensive spirit. [Note: the NATO definition does not include the second sentence.] See FM 6-20-30.

counterproliferation – Military measures centering on deterring or discouraging, as well as defending against the possible use of weapons of mass destruction. (FM 100-25)

counterpropaganda – Programs of products and actions designed to nullify propaganda or mitigate its effects. (FM 3-05.30)

counter-psychological operations – (NATO) Actions designed to detect and counteract hostile psychological activities. See FM 3-05.30.

counterreconnaissance – (DOD) All measures taken to prevent hostile observation of a force, area, or place. (Army) A tactical mission task that encompasses all measures taken by a commander to counter enemy reconnaissance and surveillance efforts. Counterreconnaissance is not a distinct mission, but a component of security operations. (FM 3-90)

counterterrorism – (DOD) Offensive measures taken to prevent, deter, and respond to terrorism. Also called **CT**.

country team – (DOD) The senior in-country coordinating and supervising body, headed by the chief of the US diplomatic mission, and composed of the senior member of each represented US department or agency, as desired by the chief of the US diplomatic mission. See FM 3-07.

coup de main – (DOD) An offensive operation that capitalizes on surprise and simultaneous execution of supporting operations to achieve success in one swift stroke. See FM 3-0.

course of action – (DOD) 1. Any sequence of activities that an individual or a unit may follow. 2. A possible plan open to an individual or a commander that would accomplish or is related to the accomplishment of a mission. 3. The scheme adopted to accomplish a job or mission. 4. A line of conduct in an engagement. 5. A product of the Joint Operation Planning and Execution System concept development phase. Also called **COA**. See FM 101-5.

cover – (DOD, NATO) 1. The action by land, air, or sea forces to protect by offense, defense, or threat of either or both. 2. Those measures necessary to give protection to a person, plan, operation, formation, or installation from the enemy intelligence effort and leakage of

information. 3. The act of maintaining a continuous receiver watch with transmitter calibrated and available, but not necessarily available for immediate use. 4. Shelter or protection, either natural or artificial. 5. (DOD only) Photographs or other recorded images which show a particular area of ground. 6. A code meaning, "Keep fighters between force/base and contact designated at distance stated from force/base" (e.g., "cover bogey twenty-seven to thirty miles"). (Army) 1. Protection from the effects of fires. (FM 6-0) 2. A form of security operation whose primary task is to protect the main body by fighting to gain time while also observing and reporting information and preventing enemy ground observation of and direct fire against the main body. Unlike a screening or guard force, the covering force is a self-contained force capable of operating independently of the main body. See also **covering force**. (FM 3-90) (See page A-6 for symbol.)

covered approach – 1. Any route that offers protection against enemy fire. 2. An approach made under the protection furnished by other forces or by natural cover. See also **concealment**; **cover**. (FM 7-10)

covering fire – (DOD, NATO) 1. Fire used to protect troops when they are within range of enemy small arms. See FM 7-10. 2. In amphibious usage, fire delivered prior to the landing to cover preparatory operations such as underwater demolition or minesweeping. See also **fire**.

covering force – (DOD, NATO) 1. A force operating apart from the main force for the purpose of intercepting, engaging, delaying, disorganizing, and deceiving the enemy before the enemy can attack the force covered. 2. Any body or detachment of troops which provides security for a larger force by observation, reconnaissance, attack, or defense, or by any combination of these methods. See FM 3-90.

covering force area – (DOD, NATO) The area forward of the forward edge of the battle area out to the forward positions initially assigned to the covering forces. It is here that the covering forces execute assigned tasks. See also **covering force**. Also called **CFA**.

covert operation – (DOD) An operation that is so planned and executed as to conceal the identity of or permit plausible denial by the sponsor. A covert operation differs from a clandestine operation in that emphasis is placed on concealment of identity of sponsor rather than on concealment of the operation. See also **clandestine operation**; **overt operation**. See FM 3-05.20.

cratering charge – (DOD, NATO) A charge placed at an adequate depth to produce a crater. (Army) A demolition charge used to create a type of point obstacle usually used to close a lane or block a road. See also **point obstacle**; **state of readiness**. (FM 3-34.2)

crisis action planning – (DOD) 1. The Joint Operation Planning and Execution System process involving the time-sensitive development of joint operation plans and orders in response to an imminent crisis. Crisis action planning follows prescribed crisis action procedures to formulate and implement an effective response within the time frame permitted by the crisis. 2. The time-sensitive planning for the deployment, employment, and sustainment of assigned and allocated forces and resources that occurs in response to a situation that may result in actual military operations. Crisis action planners base their plan on the circumstances that exist at the time planning occurs. Also called **CAP**. See also **deliberate planning**; **Joint Operation Planning and Execution System**. See FM 101-5.

- criteria of success** – Information requirements developed during the operations process that measure the degree of success in accomplishing the unit’s mission. They are normally expressed as either an explicit evaluation of the present situation or forecast of the degree of mission accomplishment. (FM 6-0)
- critical friendly zone** – An area, usually a friendly unit or location, that the maneuver commander designates as critical to the protection of an asset whose loss would seriously jeopardize the mission. (FM 3-90)
- critical habitat** – A designated area declared essential for the survival of a protected species under authority of the Endangered Species Act. (FM 3-100.4)
- cross-attachment** – The exchange of subordinate units between units for a temporary period. (FM 7-7)
- cross-country movement** – The movement of forces (usually tactical) across terrain without using roads and bridges. (FM 7-10)
- crossing area** – (DOD, NATO) 1. A number of adjacent crossing sites under the control of one commander. 2. (DOD only) A controlled access area for a river crossing operation used to decrease traffic congestion at the river. It is normally a brigade-sized area defined by lateral boundaries and release lines 3 to 4 kilometers (based on mission, enemy, terrain and weather, troops and support available, time available) [Note: the Army definition adds “and civil considerations”] from each side of the river. See also **crossing site**; **river crossing**. See FM 90-13.
- crossing area commander** – The officer responsible for the control of all crossing units, assault units, and support forces while they are in the crossing area. (FM 90-13)
- crossing force** – Normally a division-sized unit that has responsibility to establish the bridgehead. This is accomplished in four phases: the advance to the river, the assault across the river, the advance from the exit bank, and the securing of the bridgehead line. See also **bridgehead line**; **crossing area**; **crossing site**. (FM 90-13)
- crossing force commander** – The individual designated to control the lead brigades during the assault across the river to secure the bridgehead line. See also **bridgehead**. (FM 90-13)
- crossing site** – The location along a water obstacle where the crossing can be made using amphibious vehicles, assault boats, rafts, bridges, or fording vehicles. (FM 90-13) (See page 7-53 for symbol.)
- crossing site commander** – The individual, normally an engineer company commander or a platoon leader, responsible for the crossing means and crossing site. He commands the engineers operating the crossing means and the engineer regulating points at the call forward areas and staging areas for that site. See also **bridgehead**. (FM 90-13)
- cross-loading (personnel)** – (DOD) The distribution of leaders, key weapons, personnel, and key equipment among the aircraft, vessels, or vehicles of a formation to preclude the total loss of command and control or unit effectiveness if an aircraft, vessel, or vehicle is lost. It is also an important factor in aiding rapid assembly of units at the drop zone or landing zone. See FM 4-01.30.

cross tell – (DOD, NATO) The transfer of information between facilities at the same operational level. Also called **lateral tell**. See also **track telling**.

cruise missile – (DOD) Guided missile, the major portion of whose flight path to its target is conducted at approximately constant velocity; depends on the dynamic reaction of air for lift and upon propulsion forces to balance drag. See FM 44-100.

cryptosecurity – (DOD) The component of communications security that results from the provision of technically sound cryptosystems and their proper use. See also **communications security**. See FM 34-1.

culminating point – (DOD) The point at which a force no longer has the capability to continue its form of operations, offensive or defense. a. In the offense, the point at which continuing the attack is no longer possible and the force must consider reverting to a defensive posture or attempting an operational pause. b. In the defense, the point at which counteroffensive action is no longer possible. (Army) In the offense, that point in time and space where the attacker's effective combat power no longer exceeds the defender's, or the attacker's momentum is no longer sustainable, or both. In the defense, that instant at which the defender must withdraw to preserve the force. (FM 3-0)

—D—

damage assessment – (DOD, NATO) 1. The determination of the effect of attacks on targets. 2. (DOD only) A determination of the effect of a compromise of classified information on national security. See also **battle damage assessment**. See FM 34-1.

damage estimation – (DOD) A preliminary appraisal of the potential effects of an attack. See FM 34-1.

danger area – (DOD, NATO) 1. In air traffic control, an airspace of defined dimensions within which activities dangerous to the flight of aircraft may exist at specified times. See FM 3-52. 2. (DOD only) A specified area above, below, or within which there may be potential danger. (Army) Area in the vicinity of weapons or aircraft which can cause serious injury or death if occupied or passed through by individual soldiers or other equipment, such as the backblast area behind a TOW or Dragon. (FM 7-20) See also **restricted operations area/zone**.

danger close – (DOD) In close air support, artillery, mortar, and naval gunfire support fires, it is the term included in the method of engagement segment of a call for fire which indicates that friendly forces are within close proximity of the target. The close proximity distance is determined by the weapon and munition fired. (NATO) In artillery and naval fire support, a call for fire to indicate that friendly forces are within 600 meters of the target. See also **adjust fire; call for fire; final protective fires**. See FM 6-20-30.

data – (DOD) Representation of facts, concepts, or instructions in a formalized manner suitable for communication, interpretation, or processing by humans or by automatic means. Any representations such as characters or analog quantities to which meaning is or might be assigned. (Army) The lowest class of information on the cognitive hierarchy. Data consist of raw signals communicated by any nodes in an information system, or sensings from the environment detected by a collector of any kind (human, mechanical, or electronic). (FM 6-0)

datum – (DOD, NATO) Any numerical or geometrical quantity or set of such quantities which may serve as reference or base for other quantities. Where the concept is geometric, the plural form is "datums" in contrast to the normal plural "data." See FM 3-34.331.

datum (geodetic) – (DOD) 1. A reference surface consisting of five quantities: the latitude and longitude of an initial point, the azimuth of a line from that point, and the parameters of the reference ellipsoid. 2. The mathematical model of the earth used to calculate the coordinates on any map. Different nations use different datums for printing coordinates on their maps. The datum is usually referenced in the marginal information of each map. See FM 3-25.26.

day of supply – See **one day's supply**.

dazzle – (DOD) Temporary loss of vision or a temporary reduction in visual acuity; may be applied to effects on optics. See also **flash blindness**. See FM 71-123.

D-day – (DOD) The unnamed day on which a particular operation commences or is to commence. See also **times**. See FM 101-5.

deadline – (DOD) To remove a vehicle or piece of equipment from operation or use for one of the following reasons: a. is inoperative due to damage, malfunctioning, or necessary repairs (the term does not include items temporarily removed from use by reason of routine maintenance and repairs that do not affect the combat capability of the item); b. is unsafe; and c. would be damaged by further use. See also **full mission capable**. See FM 4-30.3.

dead space – (DOD, NATO) 1. An area within the maximum range of a weapon, radar, or observer, which cannot be covered by fire or observation from a particular position because of intervening obstacles, the nature of the ground, the characteristics of the trajectory, or the limitations of the pointing capabilities of the weapon. See FM 3-90. 2. An area or zone which is within range of a radio transmitter, but in which a signal is not received. 3. The volume of space above and around a gun or guided missile system into which it cannot fire because of mechanical or electronic limitations. See FM 7-20.

debarkation – (DOD) The unloading of troops, equipment, or supplies from a ship or aircraft. See also **embarkation**. See FM 100-17-3.

debriefing – (Army) The systematic questioning of individuals not in the custody of friendly forces to procure information to answer specific collection requirements by direct and indirect questioning techniques. (FM 34-52) (Marine Corps) Interviewing of an individual who has completed an intelligence or reconnaissance assignment or who has knowledge, whether through observation, participation, or otherwise, of operational or intelligence significance.

deception – (DOD, NATO) Those measures designed to mislead the enemy by manipulation, distortion, or falsification of evidence to induce the enemy to react in a manner prejudicial to the enemy's interests. See also **counterdeception; demonstration; imitative electromagnetic deception; military deception**. See FM 3-13. (See page 7-23 for symbols.)

deception event – (DOD) A deception means executed at a specific time and location in support of a deception operation. See also **deception means**. See FM 3-13.

deception means – (DOD) Methods, resources, and techniques that can be used to convey information to the deception target. There are three categories of deception means: a. **physical means** – Activities and resources used to convey or deny selected information to a foreign power. (Examples include military operations, including exercises, reconnaissance, training activities, and movement of forces; the use of dummy equipment and devices; tactics; bases, logistic actions, stockpiles, and repair activity; and test and evaluation activities); b. **technical means** – Military materiel resources and their associated operating

techniques used to convey or deny selected information to a foreign power through the deliberate radiation, re-radiation, alteration, absorption, or reflection of energy; the emission or suppression of chemical or biological odors; and the emission or suppression of nuclear particles; c. **administrative means** – Resources, methods, and techniques to convey or deny oral, pictorial, documentary, or other physical evidence to a foreign power. See FM 3-13.

deception objective – (DOD) The desired result of a deception operation expressed in terms of what the adversary is to do or not to do at the critical time and/or location. See FM 3-13.

deception story – (DOD) A scenario that outlines the friendly action that will be portrayed to cause the deception target to adopt the desired perception. See FM 3-13.

deception target – (DOD) The adversary decisionmaker with the authority to make the decision that will achieve the deception objective. See FM 3-13.

deception working group – A group tailored to bring together the special technical skills required to conduct a specific military deception operation. (FM 3-13)

decisionmaking – Selecting a course of action as the one most favorable to accomplish the mission. (FM 6-0)

decision point – (DOD) The point in space and time where the commander or staff anticipates making a decision concerning a specific friendly course of action. A decision point is usually associated with a specific target area of interest, and is located in time and space to permit the commander sufficient lead time to engage the adversary in the target area of interest. Decision points may also be associated with the friendly force and the status of ongoing operations. (Army/Marine Corps) An event, area, or point in the battlespace where and when the friendly commander will make a critical decision. (FM 101-5) Also called **DP**. See also **decision support matrix; decision support template; wargaming**. (See page 7-42 for symbol.)

decision support matrix – An aid used by the commander and staff to make battlefield decisions. It is a staff product of the wargaming process, which lists the decision point, location of the decision point, the criteria to be evaluated at the point of decision, the action or operations to occur at the decision point, and the unit or element that is to act and has responsibility to observe and report the information affecting the criteria for the decision. Also called **DSM**. See also **branch; decision point; decision support template; sequel; wargaming**. (FM 101-5)

decision support template – (DOD) A graphic record of wargaming. The decision support template depicts decision points, timelines associated with the movement of forces and the flow of the operation, and other key items of information required to execute a specific friendly course of action. (Marine Corps) A staff product initially used in the wargaming process which graphically represents the decision points and projected situations and indicates when, where, and under what conditions a decision is most likely to be required to initiate a specific activity (such as a branch or sequel) or event (such as lifting or shifting of fires). Also called **DST**. See also **decision point; decision support matrix; intelligence preparation of the battlefield; wargaming**. See FM 101-5.

decisive engagement – (DOD) In land and naval warfare, an engagement in which a unit is considered fully committed and cannot maneuver or extricate itself. In the absence of outside assistance, the action must be fought to a conclusion and either won or lost with the forces at hand. See FM 3-90.

decisive operation – The operation that directly accomplishes the task assigned by the higher headquarters. Decisive operations conclusively determine the outcome of major operations, battles, and engagements. (FM 3-0)

decisive point – (DOD) A geographic place, specific key event, critical system or function that allows commanders to gain a marked advantage over an enemy and greatly influence the outcome of an attack. See also **centers of gravity**. See FM 3-0.

decisive terrain – Key terrain whose seizure and retention is mandatory for successful mission accomplishment. See also **key terrain**. (FM 3-90)

declination – (DOD, NATO) The angular distance on the celestial sphere measured north or south through 90 degrees from the celestial equator along the hour circle of the body. Comparable to latitude on the terrestrial sphere. (Army) In navigation, at a given place and time, the angle between the grid north meridian and the true north meridian or magnetic north meridian measured in degrees or mils east or west. These change in relationship to the magnetic north meridian annually based on the drift of the magnetic pole. See also **magnetic declination; magnetic variation**. (FM 3-25.26)

deconflict – To reconcile or resolve a conflict in responsibility, area of operations, airspace, or interests in order to accomplish smooth operations without undesired redundancy or threat of fratricide. (FM 101-5)

decontaminant – Any substance used to break down, neutralize, or remove a chemical, biological, or radioactive material posing a threat to personnel or equipment. (FM 3-5)

decontamination – (DOD, NATO) The process of making any person, object or area safe by absorbing, destroying, neutralizing, making harmless, or removing chemical or biological agents, or by removing radioactive material clinging to or around it. See FM 3-5. (See page 7-60 for symbol.)

decoy – (DOD) An imitation in any sense of a person, object, or phenomenon which is intended to deceive enemy surveillance devices or mislead enemy evaluation. Also called **dummy**. See FM 20-3. (See page 7-23 for symbol.)

deep area – An area forward of the close area that commanders use to shape enemy forces before they are encountered or engaged in the close area. Typically, the deep area extends from the forward boundary of subordinate units to the forward boundary of the controlling echelon. (FM 3-0)

deep supporting fire – (NATO) Fire directed on objectives, not in the immediate vicinity of friendly forces, for neutralizing and destroying enemy reserves and weapons, and interfering with enemy command, supply, communications, and observations. See FM 6-20-30.

defeat – A tactical mission task that occurs when an enemy force has temporarily or permanently lost the physical means or the will to fight. The defeated force's commander is unwilling or unable to pursue his adopted course of action, thereby yielding to the friendly commander's will, and can no longer interfere to a significant degree with the actions of friendly forces. Defeat can result from the use of force or the threat of its use. See also **decisive point**. (FM 3-90)

defeat in detail – Concentrating overwhelming combat power against separate parts of a force in sequence rather than defeating the entire force at once. (FM 3-90)

defense in depth – (DOD, NATO) The siting of mutually supporting defense positions designed to absorb and progressively weaken attack, prevent initial observations of the whole position by the enemy, and to allow the commander to maneuver the reserve. See FM 3-90. (Army) In information operations, the integration of the capabilities of people, operations, and technology to establish multilayered, multidimensional protection. (FM 3-13)

defensive counterair – (DOD) All defensive measures designed to detect, identify, intercept, and destroy or negate enemy forces attempting to attack or penetrate the friendly air environment. Also called **DCA**. See also **counterair**; **offensive counterair**. See FM 44-100.

defensive counterspace – Operations conducted to defend against attacks by systems operating in space. Also called **DCS**. (FM 44-100)

defensive information operations – (DOD) The integration and coordination of policies and procedures, operations, personnel, and technology to protect and defend information and information systems. Defensive information operations are conducted through information assurance, physical security, operations security, counterdeception, counter-psychological operations, counterintelligence, electronic warfare, and special information operations. [Note: the Army definition does not include the previous sentence.] Defensive information operations ensure timely, accurate, and relevant information access while denying adversaries the opportunity to exploit friendly information and information systems for their own purposes. See FM 3-0.

defensive operations – (Army) Operations that defeat an enemy attack, buy time, economize forces, or develop conditions favorable for offensive operations. Defensive operations alone normally cannot achieve a decision. Their purpose is to create conditions for a counteroffensive that allows Army forces to regain the initiative. (FM 3-0) (Marine Corps) Operations conducted with the immediate purpose of causing an enemy attack to fail. Defensive operations also may achieve one or more of the following: gain time; concentrate forces elsewhere; wear down enemy forces as a prelude to offensive operations; and retain tactical, strategic, or political objectives. See also **area defense**; **mobile defense**.

defilade – (DOD, NATO) 1. Protection from hostile observation and fire provided by an obstacle such as a hill, ridge, or bank. 2. A vertical distance by which a position is concealed from enemy observation. 3. To shield from enemy fire or observation by using natural or artificial obstacles. See FM 7-20.

defilade fire – (Army) Fire delivered at a rate intentionally less than sustained to permit adjustment corrections, meet specific tactical requirements, or conserve ammunition. (Marine Corps) Fire delivered on a target in such a manner that the range pattern of the fall of shot generally aligns with the short axis of the target. See also **enfilade fire**; **sustained rate of fire**.

defile – 1. A narrow gorge or pass that tends to prevent easy movement of troops. (FM 7-10) 2. A special movement circulation control measure. A defile operation is conducted to keep traffic moving smoothly through a narrow passageway. (FM 3-19.4)

degrade – In information operations, using nonlethal or temporary means to reduce the effectiveness or efficiency of adversary command and control systems and information collection efforts or means. (FM 3-13)

degree of risk – (DOD) As specified by the commander, the risk to which friendly forces may be subjected from the effects of the detonation of a nuclear weapons used in the attack of a

close-in enemy target; acceptable degrees of risk under differing tactical conditions are emergency, moderate, and negligible. See also **emergency risk (nuclear)**; **moderate risk (nuclear)**; **negligible risk (nuclear)**; **radiation status**. See FM 3-11.4.

delay – A form of retrograde in which a force under pressure trades space for time by slowing the enemy's momentum and inflicting maximum damage on the enemy without, in principle, becoming decisively engaged. (FM 3-90) (See page A-3 for symbol.)

delaying operation (DOD, NATO) – See **delay**.

delay line – A phase line where the date and time before which the enemy is not allowed to cross the phase line is depicted as part of the graphic control measure. (FM 3-90)

delegation of authority – (DOD) The action by which a commander assigns part of his or her authority commensurate with the assigned task to a subordinate commander. While ultimately responsibility cannot be relinquished, delegation of authority carries with it the imposition of a measure of responsibility. The extent of the authority delegated must be clearly stated. (NATO) An action by which a commander assigns to a subordinate commander a clearly stated part of his authority. See also **command**. See FM 6-0.

deliberate attack – (DOD, NATO) A type of offensive action characterized by preplanned coordinated employment of firepower and maneuver to close with and destroy or capture the enemy. See also **attack**; **deliberate operation**. See FM 3-0.

deliberate crossing – (DOD, NATO) The crossing of an inland water obstacle that requires extensive planning and detailed preparations. See also **bridgehead**; **bridgehead line**; **hasty crossing**; **river crossing**. See FM 90-13.

deliberate defense – (DOD, NATO) A defense normally organized when out of contact with the enemy or when contact with the enemy is not imminent and time for organization is available. It normally includes an extensive fortified zone incorporating pillboxes, forts, and communications systems. See also **defense in depth**; **deliberate operation**; **forward defense**; **hasty defense**. See FM 7-20.

deliberate operation – An operation in which a commander's detailed intelligence concerning the situation allows him to develop and coordinate detailed plans, including multiple branches and sequels. He task organizes his forces specifically for the operation to provide a fully synchronized combined arms team. He conducts extensive rehearsals while conducting extensive shaping operations to set the conditions for the conduct of his decisive operation. (FM 3-90)

deliberate planning – (DOD) 1. The Joint Operation Planning and Execution System process involving the development of joint operation plans for contingencies identified in joint strategic planning documents. Conducted principally in peacetime, deliberate planning is accomplished in prescribed cycles that complement other Department of Defense planning cycles in accordance with the formally established Joint Strategic Planning System. 2. A planning process for the deployment and employment of apportioned forces and resources that occurs in response to a hypothetical situation. Deliberate planners rely heavily on assumptions regarding the circumstances that will exist when the plan is executed. See also **contingency**; **fragmentary order**; **Joint Operation Planning and Execution System**; **warning order**. See FM 101-5.

deliberate smoke – Smoke operations conducted with detailed planning and executed by either on-hand smoke assets or with those on-hand augmented by corps and theater assets. Deliberate smoke operations normally are synchronized with specific time, events, or locations on the battlefield. Deliberate smoke operations normally include multiple preplanned smoke operations. They cover large areas over long periods to support the operations of brigades, divisions, and corps. (FM 3-50)

demilitarized zone – (DOD, NATO) A defined area in which the stationing or concentrating of military forces, or the retention or establishment of military installations of any description is prohibited. Also called **DMZ**. See also **area of separation**; **buffer zone**. See FM 3-07.

demining – Activities to remove the hazard of all mines and other unexploded explosive munitions from a defined area. (FM 20-32)

demobilization – (DOD) The process of transitioning a conflict or wartime military establishment and defense-based civilian economy to a peacetime configuration while maintaining national security and economic vitality. (Army) The act of returning the force and materiel to a premobilization posture or to some other approved position. It also involves returning the mobilized portion of the industrial base to peacetime conditions. See also **mobilization**. (FM 100-17)

demolition – (NATO) The destruction of structures, facilities, or material by use of fire, water, explosives, mechanical, or other means. See FM 5-250.

demolition chamber – (DOD, NATO) Space intentionally provided in a structure for the emplacement of explosive charges. See FM 5-250.

demolition firing party – (DOD) The party at the site that is technically responsible for the demolition and that actually initiates detonation or fires the demolitions. See also **demolition guard**; **state of readiness**. See FM 5-250.

demolition guard – (DOD, NATO) A local force positioned to ensure that a target is not captured by an enemy before orders are given for its demolition and before the demolition has been successfully fired. The commander of the demolition guard is responsible for the tactical control of all troops at the demolition site, including the demolition firing party. The commander of the demolition guard is responsible for transmitting the order to fire to the demolition firing party. See also **demolition firing party**. See FM 5-250.

demolition kit – (DOD, NATO) The demolition tool kit complete with explosives. See FM 5-250.

demolition obstacle – An obstacle created by using explosives. (FM 5-250)

demolition plan – Documentation with data required for the preparation of a single demolition. (FM 5-250)

demolition target – (DOD, NATO) A target of known military interest identified for possible future demolition. See FM 5-250.

demonstration – (DOD, NATO) 1. An attack or show of force on a front where a decision is not sought, made with the aim of deceiving the enemy. 2. (DOD only) In military deception, a show of force in an area where a decision is not sought; made to deceive an adversary. It is similar to a feint but no actual contact with the adversary is intended. (Army) 1. A form of attack designed to deceive the enemy as to the location or time of the decisive operation by a

display of force. Forces conducting a demonstration do not seek contact with the enemy. (FM 3-0) 2. In stability operations and support operations, an operation by military forces in sight of an actual or potential adversary to show military capabilities. (FM 3-07) See also **deception; diversion; show of force**. (See page 9-7 for symbol.)

denial measure – (DOD, NATO) An action to hinder or deny the enemy the use of space, personnel, or facilities. It may include destruction, removal, contamination, or erection of obstructions. [Note: the Army uses the term “denial operation.”]

denial operation – Action to hinder or deny the enemy the use of space, personnel, supplies, and facilities. (FM 3-90)

denied area – (DOD) An area under enemy or unfriendly control in which friendly forces cannot expect to operate successfully within existing operational constraints and force capabilities. (Army) An area that is operationally unsuitable for general purpose forces due to political, tactical, environmental, or geographical reasons. It is a primary area for special operations forces. (FM 100-25)

deny – (Army) In information operations, entails withholding information about Army force capabilities and intentions that adversaries need for effective and timely decisionmaking. (FM 3-13) (Marine Corps) To hinder or prevent the enemy from using terrain, space, personnel, supplies, or facilities. See also **denial measure**.

departure airfield – (DOD) An airfield on which troops and/or materiel are enplaned for flight. See also **aerial port of debarkation; aerial port of embarkation**. See FM 55-1.

departure point – (DOD, NATO) 1. A navigational check point used by aircraft as a marker for setting course. 2. In amphibious operations, an air control point at the seaward end of the helicopter approach lane system from which helicopter waves are dispatched along the selected helicopter approach lane to the initial point. (Army) That point, assembly area, airfield, or other location from which an aircraft begins an aeronautical mission. See also **air control point; air corridor; pickup zone**. (FM 3-04.111)

deployment – (DOD, NATO) 1. In naval usage, the change from a cruising approach or contact disposition to a disposition for battle. 2. The movement of forces within operational areas. 3. The positioning of forces into a formation for battle. 4. The relocation of forces and materiel to desired operational areas. Deployment encompasses all activities from origin or home station through destination, specifically including intracontinental United States, intertheater, and intratheater movement legs, staging, and holding areas. [Note: the NATO definition does not include the second sentence.] (Army) Those activities required to prepare and move a force and its sustainment equipment and supplies to the area of operations in response to a crisis or natural disaster. See also **force projection**. (FM 100-17)

depot – (DOD) 1. supply—An activity for the receipt, classification, storage, accounting, issue, maintenance, procurement, manufacture, assembly, research, salvage, or disposal of material. 2. personnel—An activity for the reception, processing, training, assignment, and forwarding of personnel replacements. [Note: Army definition does not include personnel activities.] See also **classes of supply; combat service support**. See FM 10-1.

depression angle – See **angle of depression**.

depth – The extension of operations in time, space, and resources. (FM 3-0)

describe – To relate operations to time and space in terms of accomplishing the purpose of the overall mission. (FM 6-0)

description of target – (NATO) In artillery and naval fire support, an element in the call for fire in which the observer or spotter describes the installation, personnel, equipment, or activity to be taken under fire. [Note: the Army definition also applies to mortar fire.] Also called **target description**. See FM 6-30.

desired ground zero – (DOD, NATO) The point on the surface of the Earth at, or vertically below or above, the center of a planned nuclear detonation. Also called **DGZ**. See also **ground zero**. See FM 100-30.

desired perception – (DOD) In military deception, what the deception target must believe for it to make the decision that will achieve the deception objective. See FM 3-13.

destroy – 1. A tactical mission task that physically renders an enemy force combat-ineffective until it is reconstituted. 2. To damage a combat system so badly that it cannot perform any function or be restored to a usable condition without being entirely rebuilt. (FM 3-90) (See page A-3 for symbol.)

destruction – (DOD) A type of adjustment for destroying a given target. (Army) 1. When referring to the effects of field artillery fires, a target out of action permanently, or 30 percent casualties or material damage. (FM 6-20) 2. When used in an attack helicopter mission, the percentage of destroyed or disabled vehicles must be specified by the higher commander. (FM 1-112)

destruction fire – (DOD) Fire delivered for the sole purpose of destroying material objects. See also **destroy**; **fire support**. See FM 6-30.

destruction radius – (DOD, NATO) In mine warfare, the maximum distance from an exploding charge of stated size and type at which a mine will be destroyed by sympathetic detonation of the main charge, with a stated probability of destruction, regardless of orientation. See FM 20-32.

detachment – (DOD, NATO) 1. A part of a unit separated from its main organization for duty elsewhere. 2. A temporary military or naval unit formed from other units or parts of units. (Army) The basic organizational unit of the US Army Special Forces. Also called **DET**. See also **assign**; **attach**; **command relationship**; **operational control**. (FM 3-05.20) (See page 5-33 for symbol.)

detachment left in contact – An element left in contact as part of the previously designated (usually rear) security force while the main body conducts its withdrawal. Also called **DLIC**. See also **breakout**; **retrograde**. (FM 3-90)

detailed equipment decontamination – In thorough decontamination, removing, neutralizing, or reducing contamination on interior and exterior surfaces of unit equipment to negligible risk levels to allow the removal of mission-oriented protective posture (MOPP) gear or education in MOPP level for extended periods. (FM 3-5)

detailed troop decontamination – In thorough decontamination, reducing mission-oriented protective posture (MOPP) levels for extended periods by decontaminating individual fighting equipment to negligible risk levels, removing contaminated MOPP gear including

protective masks, decontaminating protective masks, and monitoring personnel and equipment for effectiveness of decontamination. (FM 3-5)

detained – (DOD) A casualty who is prevented from proceeding or is restrained in custody for alleged violation of international law or other reason claimed by the government or group under which the person is being held. See also **missing**. See FM 4-02.

detainee – (DOD) A term used to refer to any person captured or otherwise detained by an armed force. (Army) An individual who is captured by or placed in the custody of a duly constituted governmental organization for a period of time. See also **missing**. (FM 34-52)

deterrence – (DOD) The prevention from action by fear of the consequences. Deterrence is a state of mind brought about by the existence of a credible threat of unacceptable counteraction. See FM 1.

detonating cord – (DOD, NATO) A waterproof, flexible fabric tube containing a high explosive designed to transmit the detonation wave. See also **demolition**. See FM 5-250.

detonator – (DOD, NATO) A device containing a sensitive explosive intended to produce a detonation wave. See FM 5-250.

dew point spread – The degree of difference between the air temperature and the dew point that indicates if fog will begin to form. (FM 3-04.111)

diamond formation – A tactical or movement formation that is a variation of the box formation with one maneuver unit leading, maneuver units positioned on each flank, and the remaining maneuver unit to the rear. See also **box formation**; **formation**. (FM 3-90)

died of wounds – A hostile or battle casualty who dies after having reached a medical treatment facility. Also called **DOW**. See also **hostile casualty**; **killed in action**. (FM 8-55)

died of wounds received in action – (DOD) A casualty category applicable to a hostile casualty, other than the victim of a terrorist activity, who dies of wounds or other injuries received in action after having reached a medical treatment facility. Also called **DWRIA**. See FM 8-55.

direct – To communicate execution information. (FM 6-0)

direct action – (DOD) Short-duration strikes and other small-scale offensive actions by special operations forces or special operations-capable units to seize, destroy, capture, recover, or inflict damage on designated personnel or materiel. In the conduct of these operations, special operations forces or special operations-capable units may employ raid, ambush, or direct assault tactics; emplace mines and other munitions; conduct standoff attacks by fire from air, ground, or maritime platforms; provide terminal guidance for precision-guided munitions; conduct independent sabotage; and conduct anti-ship operations. Also called **DA**. See also **special operations**; **special operations forces**. See FM 100-25.

direct action mission – In special operations, a specified act involving operations of an overt, clandestine, or low-visibility nature conducted primarily by special operations forces in hostile or denied areas. See also **direct action**. (FM 100-25)

direct approach – To apply combat power directly against the enemy center of gravity or the enemy's principal strength. (FM 3-0)

directed obstacle – An obstacle directed by a higher commander as a specified task to a subordinate unit. (FM 3-34.2)

directed target – A target directed by the responsible commander to be prepared for demolition or destroyed to support his intent. (FM 5-100)

directed telescope – A dedicated information collector—a trusted and like-minded subordinate—used to observe selected events or units and report directly to the commander. (FM 6-0)

direct exchange – (DOD) A supply method of issuing serviceable materiel in exchange for unserviceable materiel on an item-for-item basis. Also called **DX**. See FM 10-1.

direct fire – (DOD) Gunfire delivered on a target, using the target itself as a point of aim for either the gun or the director. [Note: the Army definition includes missile and rocket fire.] See FM 7-20.

direction finding – (DOD) A procedure for obtaining bearings of radio frequency emitters by using a highly directional antenna and a display unit on an intercept receiver or ancillary equipment. (Army) The procedures to determine a line of bearing to a communications, radar, or other electromagnetic emitter.

direction of attack – (DOD) A specific direction or route that the main attack or center of mass of the unit will follow. The unit is restricted, required to attack as indicated, and is not normally allowed to bypass the enemy. The direction of attack is used primarily in counterattacks or to ensure that supporting attacks make maximal contribution to the main attack. (Army) A specific direction or assigned route a force uses and does not deviate from when attacking. See also **axis of advance**. (FM 3-90) (See page 7-29 for symbol.)

direction of fire – The direction on which a cannon, rocket, gun, or missile is laid. It represents the direction to the most significant threat in the target area. (FM 6-20-10)

direct laying – (DOD) Laying in which the sights of weapons are aligned directly on the target. Normally used in conjunction with mortars and sometimes artillery. See also **lay**. See FM 6-20-10.

direct pressure force – A force employed in a pursuit operation that orients on the enemy main body to prevent enemy disengagement or defensive reconstitution prior to envelopment by the encircling force. It normally conducts a series of hasty attacks to slow the enemy's retirement by forcing him to stand and fight. See also **encircling force**. (FM 3-90)

direct support – (DOD) A mission requiring a force to support another specific force and authorizing it to answer directly the supported force's request for assistance. [Note: Army designates this as a "support relationship" instead of "mission."] (NATO) 1. The support provided by a unit or formation not attached to, nor under command of, the supported unit or formation, but required to give priority to the support required by that unit or formation. 2. In maritime usage, operations related to the protection of a specific force by other units, normally under the tactical control of that force. Also called **DS**. See FM 101-5.

direct support artillery – (DOD, NATO) Artillery whose primary task is to provide fire requested by the supported unit. See also **general support**. See FM 6-30.

direct support unit – Unit providing supply and maintenance support directly to a using or consuming unit. Also called **DSU**. (FM 4-0)

disarmed mine – (DOD) A mine for which the arming procedure has been reversed, rendering the mine inoperative. It is safe to handle and transport and can be rearmed by simple action. (NATO) A previously armed mine which has been returned to a safe state. See FM 20-32.

discharge – The accidental or intentional spilling, leaking, pumping, pouring, emitting, emptying, or dumping of a substance into or on any land or water. (FM 3-100.4)

disease and nonbattle injury casualty – (DOD) A person who is not a battle casualty but who is lost to the organization by reason of disease or injury, including persons dying of disease or injury, by reason of being missing where the absence does not appear to be voluntary, or due to enemy action or being interned. Also called **DNBI** casualty. See FM 4-02.17.

disengage – A tactical mission task where a commander has his unit break contact with the enemy to allow the conduct of another mission or to avoid decisive engagement. (FM 3-90)

disengagement – (DOD) In arms control, a general term for proposals that would result in the geographic separation of opposing nonindigenous forces without directly affecting indigenous military forces. See FM 3-07.

disengagement line – A phase line located on identifiable terrain that, when crossed by the enemy, signals to defending elements that it is time to displace to their next position. (FM 3-90)

disinformation – Information disseminated primarily by intelligence organizations or other covert agencies designed to distort information or deceive or influence US decisionmakers, US forces, coalition allies, key actors, or individuals via indirect or unconventional means. (FM 3-13)

dislocated civilian – (DOD) A broad term that includes a displaced person, an evacuee, an expellee, an internally displaced person, a migrant, refugee, or a stateless person. (Army) A generic term that describes a civilian who has been forced to move by war, revolution, or natural or man-made disaster from his or her home to some other location. Dislocated citizens include displaced persons, refugees, evacuees, stateless persons, and war victims. Legal and political considerations define the subcategories of a dislocated civilian. Also called **DC**. See also **displaced person; refugee**. (FM 3-07)

dismounted marches – Movements of troops and equipment mainly by foot, with limited support by vehicles. Also called **foot marches**. (FM 3-90)

dispersion – (DOD, NATO) 1. A scattered pattern of hits around the mean point of impact of bombs and projectiles dropped or fired under identical conditions. 2. In anti-aircraft gunnery, the scattering of shots in range and deflection about the mean point of explosion. See FM 44-100. 3. The spreading or separating of troops, materiel, establishments, or activities which are usually concentrated in limited areas to reduce vulnerability. 4. In chemical and biological operations, the dissemination of agents in liquid or aerosol form. See FM 3-7. 5. In airdrop operations, the scatter of personnel and/or cargo on the drop zone. See FM 90-26.

displace – To leave one position and take another. Forces may be displaced laterally to concentrate combat power in threatened areas. See also **delay**. (FM 6-20-10)

displaced person – (DOD) A civilian who is involuntarily outside the national boundaries of his or her country. [Note: the Army definition adds: “or as an internally displaced person is a civilian involuntarily outside his area or region within his country.”] See also **dislocated civilian**; **refugee**. See FM 34-1.

display – (DOD) In military deception, a static portrayal of an activity, force, or equipment intended to deceive the adversary’s visual observation. See FM 3-13. (Army) An information management activity: to represent relevant information in a usable, easily understood audio or visual form tailored to the needs of the user that conveys the common operational picture for decisionmaking and exercising command and control functions. (FM 6-0)

disposal (waste) – The discharge, deposit, injection, dumping, spilling, leaking, or placing of any solid waste or hazardous waste into or on any land or water. The act is such that the solid waste or hazardous waste, or any constituent thereof, may enter the environment or be emitted into the air or discharged into any waters, including ground water. (FM 3-100.4)

disposition – (DOD, NATO) 1. Distribution of the elements of a command within an area, usually the exact location of each unit headquarters and the deployment of forces subordinate to it. See FM 6-0. 2. A prescribed arrangement of the stations to be occupied by the several formations and single ships of a fleet, or major subdivisions of a fleet, for any purpose, such as cruising, approach, maintaining contact, or battle. 3. A prescribed arrangement of all the tactical units composing a flight or a group of aircraft. See FM 3-04.111. 4. (DOD only) The removal of a patient from a medical treatment facility by reason of return to duty, transfer to another treatment facility, death, or other termination of medical case. See also **deployment**; **dispersion**. See FM 8-55.

disregard this transmission-out – A procedure word meaning, “This transmission is in error. Disregard it.” (This procedure word shall not be used to cancel any message that has been completely transmitted and for which receipt or acknowledgment has been received.) See also **procedure word**. (FM 24-19)

disrupt – 1. A tactical mission task in which a commander integrates direct and indirect fires, terrain, and obstacles to upset an enemy’s formation or tempo, interrupt his timetable, or cause his forces to commit prematurely or attack in piecemeal fashion. (FM 3-90) 2. An engineer obstacle effect that focuses fire planning and obstacle effort to cause the enemy to break up his formation and tempo, interrupt his timetable, commit breaching assets prematurely, and attack in a piecemeal effort. (FM 90-7) 3. In information operations, breaking and interrupting the flow of information between selected command and control nodes. (FM 3-13) (See pages 7-50 and A-3 for symbol.)

disseminate – An information management activity: to communicate relevant information of any kind from one person or place to another in a usable form by any means to improve understanding or to initiate or govern action. (FM 6-0)

distribution – (DOD) 1. The arrangement of troops for any purpose, such as a battle, march, or maneuver. 2. A planned pattern of projectiles about a point. 3. A planned spread of fire to cover a desired frontage or depth. 4. An official delivery of anything, such as orders or supplies. 5. The operational process of synchronizing all elements of the logistic system to deliver the “right things” to the “right place” at the “right time” to support the geographic combatant commander. 6. The process of assigning military personnel to activities, units, or billets. See FM 100-10-1.

distribution manager – (DOD) The executive agent for managing distribution with the combatant commander's area of responsibility. See also **area of responsibility**; **distribution**. See FM 100-10-1.

distribution pipeline – (DOD) Continuum or channel through which the Department of Defense conducts distribution operations. The distribution pipeline represents the end-to-end flow of resources from supplier to consumer and, in some cases, back to the supplier in retrograde activities. See FM 100-10-1.

distribution plan – (DOD) A reporting system comprising reports, updates and information system feeds that articulate the requirements of the theater distribution system to the strategic and operational resources assigned responsibility for support to the theater. It portrays the interface of the physical, financial, information and communications networks for gaining visibility of the theater distribution system and communicates control activities necessary for optimizing capacity of the system. It depicts, and is continually updated to reflect changes in, infrastructure, support relationships, and customer locations to all elements of the distribution system (strategic, operational, and tactical). See also **distribution**; **distribution system**; **theater distribution**; **theater distribution system**. See FM 100-10-1.

distribution point – (DOD, NATO) A point at which supplies and/or ammunition, obtained from supporting supply points by a division or other unit, are broken down for distribution to subordinate units. Distribution points usually carry no stocks; items drawn are issued completely as soon as possible. See FM 10-1.

distribution system – (DOD) That complex of facilities, installations, methods, and procedures designed to receive, store, maintain, distribute, and control the flow of military materiel between the point of receipt into the military system and the point of issue to using activities and units. See FM 100-10-1.

diversion – (DOD) 1. The act of drawing the attention of forces of an enemy from the point of the principal operation; an attack, alarm, or feint that diverts attention. 2. A change made in a prescribed route for operational or tactical reasons. A diversion order will not constitute a change of destination. 3. A rerouting of cargo or passengers to a new transshipment point or destination or on a different mode of transportation prior to arrival at ultimate destination. See FM 4-01.30. 4. In naval mine warfare, a route or channel bypassing a dangerous area. A diversion may connect one channel to another or it may branch from a channel and rejoin it on the other side of the danger. See also **deception**; **demonstration**.

division – (DOD, NATO) 1. A tactical unit/formation as follows: a. A major administrative and tactical unit/formation which combines in itself the necessary arms and services required for sustained combat, larger than a regiment/brigade and smaller than a corps. b. A number of naval vessels of similar type grouped together for operational and administrative command, or a tactical unit of a naval aircraft squadron, consisting of two or more sections. c. An air division is an air combat organization normally consisting of two or more wings with appropriate service units. The combat wings of an air division will normally contain similar type units. 2. An organizational part of a headquarters that handles military matters of a particular nature, such as personnel, intelligence, plans, and training, or supply and evacuation. 3. A number of personnel of a ship's complement grouped together for tactical and administrative control. (Army) The largest fixed organization in the Army that trains and fights as a tactical team and is organized with varying numbers and types of combat,

combat support, and combat service support units. Also called **div.** (FM 3-90) (See page 5-32 for symbol.)

division support area – An area normally located in the division rear and often positioned near air-landing facilities along the main supply route. The division support area contains the portions of the division rear command post, division support command (DISCOM) command post, and units organic and attached to the DISCOM. It may also contain the corps support command units supporting the division and nondivisional units in the division area. Also called **DSA.** (FM 63-2) (See page 7-71 for symbol.)

doctrinal template – (DOD) A model based on known or postulated adversary doctrine. Doctrinal templates illustrate the disposition and activity of adversary forces and assets conducting a particular operation unconstrained by the effects of the battlespace. They represent the application of adversary doctrine under ideal conditions. Ideally, doctrinal templates depict the threat's normal organization for combat, frontages, depths, boundaries and other control measures, assets available from other commands, objective depths, engagement areas, battle positions, and so forth. Doctrinal templates are usually scaled to allow ready use with geospatial products. See also **doctrine.** See FM 34-130.

doctrine – (DOD) Fundamental principles by which the military forces or elements thereof guide their actions in support of national objectives. It is authoritative but requires judgment in application. (NATO) Fundamental principles by which the military forces guide their actions in support of objectives. It is authoritative but requires judgment in application. See FM 3-0.

document exploitation – The systematic extraction of information from documents either produced by the threat, having been in the possession of the threat, or that are directly related to the current or future threat situation for the purpose of producing intelligence or answering information requirements. This may be conducted in conjunction with human intelligence (HUMINT) collection activities or may be conducted as a separate activity. Also called **DOCEX.** (FM 34-52)

domestic emergencies – (DOD) Emergencies affecting the public welfare and occurring within the 50 states, District of Columbia, Commonwealth of Puerto Rico, US possessions and territories, or any political subdivision thereof, as a result of enemy attack, insurrection, civil disturbances, earthquake, fire, flood, or other public disasters, or equivalent emergencies that endanger life and property or disrupt the usual process of government. The term domestic emergency includes any or all of the emergency conditions defined below: a. **civil defense emergency**—A domestic emergency disaster situation resulting from devastation created by an enemy attack and requiring emergency operations during and following that attack. It may be proclaimed by appropriate authority in anticipation of an attack. b. **civil disturbances**—Riots, acts of violence, insurrections, unlawful obstructions or assemblages, or other disorders prejudicial to public law and order. The term civil disturbances includes all domestic conditions requiring or likely to require the use of Federal Armed Forces pursuant to the provisions of Chapter 15 of Title 10, United States Code. c. **major disaster**—Any flood, fire, hurricane, tornado, earthquake, or other catastrophe which, in the determination of the President, is or threatens to be of sufficient severity and magnitude to warrant disaster assistance by the federal Government under Public Law 606, 91st Congress (42 United States Code 58) to supplement the efforts and available resources of State and local governments in alleviating the damage, hardship, or suffering caused thereby. d. **natural disaster**—All domestic emergencies except those created as a result of enemy attack or civil disturbance. See FM 3-07.

domestic support operations – (DOD) Those activities and measures taken by the Department of Defense to foster mutual assistance and support between the Department of Defense and any civil government agency in planning or preparedness for, or in the application of resources for response to, the consequences of civil emergencies or attacks, including national security emergencies. See FM 3-07.

dominant terrain – See **key terrain**.

dominant user concept – (DOD) The concept that the Service that is the principal customer will have the responsibility for performance of a support workload for all using Services. See FM 10-1.

do not answer – A procedure word meaning, “Stations called are not to answer this call, receipt for this message, or otherwise transmit in connection with this transmission.” When this procedure word is employed, the transmission shall be ended with the procedure word “Out.” See also **procedure word**. (FM 24-19)

dormant – (DOD, NATO) In mine warfare, the state of a mine during which a time delay feature in a mine prevents it from being actuated. See FM 20-32.

dose rate – The amount of ionizing or nuclear radiation that an individual would receive during a unit of time. It is usually expressed in centigray (cGy) per hour. Dose rate is commonly used to indicate the level of radioactivity in a contaminated area. (FM 3-3-1)

dose rate contour line – (DOD, NATO) A line on a map, diagram, or overlay joining all points at which the radiation dose rate at a given time is the same. See FM 3-3-1. (See page 7-61 for symbol.)

doubtful – (NATO) In artillery and naval fire support, a term used by an observer or spotter to indicate that he was unable to determine the difference in range between the target and a round or rounds. [Note: the Army definition also applies to mortar fire.] See FM 6-30.

down – (NATO) In artillery and naval fire support: a. A term used in a call for fire to indicate that the target is at a lower altitude than the reference point used in identifying the target. b. A correction used by an observer/spotter in time fire to indicate that a decrease in height of burst is desired. [Note: the Army definition also applies to mortar fire.] See FM 6-30.

downed aircrew pickup point – A point where aviators will attempt to evade and escape to be recovered by friendly forces. (FM 3-04.111) (See page 7-22 for symbol.)

downwind hazard area – The area downwind of a nuclear, biological, or chemical attack that may present a hazard to unprotected troops. (FM 3-3)

downwind hazard prediction – A prediction of the possible extent of chemical hazard prepared by a corps or division nuclear, biological, chemical center following an attack. (FM 3-3)

drill mine – (DOD, NATO) An inert filled mine or mine-like body, used in loading, laying, or discharge practice and trials. See also **mine**. See FM 20-32.

drop – (NATO) In artillery and naval fire support, a correction used by an observer/spotter to indicate that a decrease in range along a spotting line is desired. [Note: the Army definition also applies to mortar fire.] See FM 6-30. (Army) Parachute jump, individual or in mass, or

supply delivery by parachute from an aircraft in flight, or the act of making such a jump or delivery. (FM 90-26)

drop zone – (DOD, NATO) A specific area upon which airborne troops, equipment, or supplies are airdropped. Also called **DZ**. See FM 90-26. (See page 7-17 for symbol.)

dual-firing circuit – (DOD, NATO) An assembly comprising two independent firing systems, both electric or both non-electric, so that the firing of either system will detonate all charges. See also **demolition; state of readiness**. See FM 5-250.

dud – (DOD, NATO) Explosive munition which has not been armed as intended or which has failed to explode after being armed. See FM 5-250.

dummy – See **decoy**.

dummy minefield – (DOD) In naval warfare, a mine field containing no live mines and presenting only a psychological threat.

—E—

early warning – (DOD, NATO) Early notification of the launch or approach of unknown weapons or weapon carriers. Also called **EW**. See also **air defense**. See FM 44-100.

echelon – (DOD, NATO) 1. A subdivision of a headquarters, i.e., forward echelon, rear echelon. See FM 6-0. 2. Separate level of command. As compared to a regiment, a division is a higher echelon; a battalion is a lower echelon. 3. A fraction of a command in the direction of depth to which principal combat mission is assigned, i.e., attack echelon, support echelon, reserve echelon. See FM 3-90. 4. A formation in which its subdivisions are placed one behind another, with a lateral and even spacing to the same side. See FM 3-90.

echelon formation – A unit formation with subordinate elements arranged on an angle to the left or to the right of the direction of attack (echelon left, echelon right). This formation provides for firepower forward and to the flank of the direction of the echelon. It facilitates control in open areas. It provides minimal security to the opposite flank of the direction of the echeloning. See also **box formation; formation; line formation; movement formation; vee formation; wedge formation**. (FM 3-90)

echelons above corps – Army headquarters and organizations that provide the interface between the theater commander (joint or multinational) and the corps for operational matters. Also called **EAC**. (FM 100-7)

economy of force – (Army) One of the nine principles of war: Allocate minimum essential combat power to secondary efforts. (FM 3-0) (Marine Corps) The allocation of minimum-essential combat capability to supporting efforts, with attendant degree of risk, so that combat power may be concentrated on the main effort. Economy of force is used to describe a principle of war and a condition of tactical operations, and not used to describe a mission. See also **decisive operations; main effort; principles of war**.

effective downwind message – A message that forecasts wind speed and direction at heights corresponding to preselected nuclear weapon yields. (FM 3-3-1)

effectiveness (of target audience) – The ability of a target audience to effect the desired reaction or behavior in themselves or others in response to a psychological activity or psychological operation message. (FM 3-05.30)

electromagnetic deception – (DOD) The deliberate radiation, re-radiation, alteration, suppression, absorption, denial, enhancement, or reflection of electromagnetic energy in a manner intended to convey misleading information to an enemy or enemy electromagnetic-dependent weapons, thereby degrading or neutralizing the enemy's combat capability. Among the types of electromagnetic deception are: a. **manipulative electromagnetic deception**—Actions to eliminate revealing, or convey misleading, electromagnetic telltale indicators that may be used by hostile forces; b. **simulative electromagnetic deception**—Actions to simulate friendly, notional, or actual capabilities to mislead hostile forces; c. **imitative electromagnetic deception**—The introduction of electromagnetic energy into enemy systems that imitates enemy emissions. See also **electronic warfare; information operations**. See FM 3-13.

electromagnetic interference – (DOD) Any electromagnetic disturbance that interrupts, obstructs, or otherwise degrades or limits the effective performance of electronics and electrical equipment. It can be induced intentionally, as in some forms of electronic warfare, or unintentionally, as a result of spurious emissions and responses, intermodulation products, and the like. Also called **EMI**. See also **jamming**. See FM 34-1.

electromagnetic pulse – (DOD) The electromagnetic radiation from a strong electronic pulse, most commonly caused by a nuclear explosion, that may couple with electrical or electronic systems to produce damaging current and voltage surges. Also called **EMP**. See also **electromagnetic radiation**. See FM 3-3-1.

electromagnetic radiation – (DOD) Radiation made up of oscillating electric and magnetic fields and propagated with the speed of light. Includes gamma radiation, X-rays, ultraviolet, visible, and infrared radiation, and radar and radio waves. See FM 34-1.

electromagnetic spectrum – (DOD) The range of frequencies of electromagnetic radiation from zero to infinity. It is divided into 26 alphabetically designated bands. See also **electronic warfare**. See FM 3-13.

electronic attack – (DOD) That division of electronic warfare involving the use of electromagnetic energy, directed energy, or antiradiation weapons to attack personnel, facilities, or equipment with the intent of degrading, neutralizing, or destroying enemy combat capability and is considered a form of fires. Also called **EA**. EA includes: 1. actions taken to prevent or reduce an enemy's effective use of the electromagnetic spectrum, such as jamming and electromagnetic deception, and 2. employment of weapons that use either electromagnetic or directed energy as their primary destructive mechanism (lasers, radio frequency weapons, particle beams), or antiradiation weapons. See also **electronic warfare; information operations**. See FM 34-1.

electronic intelligence – (DOD) Technical and geolocation intelligence derived from foreign noncommunications electromagnetic radiations emanating from other than nuclear detonations or radioactive sources. Also called **ELINT**. See also **electronic warfare; signals intelligence**. See FM 34-1.

electronic protection – (DOD) That division of electronic warfare involving passive and active means taken to protect personnel, facilities, and equipment from any effects of friendly or enemy employment of electronic warfare that degrade, neutralize or destroy friendly combat capability. Also called **EP**. See also **electronic warfare**. See FM 34-1

electronic warfare – (DOD) Any military action involving the use of electromagnetic and directed energy to control the electromagnetic spectrum or to attack the enemy. Also called **EW**. The three major subdivisions within electronic warfare are: electronic attack, electronic protection, and electronic warfare support. a. **electronic attack**—That division of electronic warfare involving the use of electromagnetic energy, directed energy, or antiradiation weapons to attack personnel, facilities, or equipment with the intent of degrading, neutralizing, or destroying enemy combat capability and is considered a form of fires. Also called **EA**. EA includes: 1. actions taken to prevent or reduce an enemy's effective use of the electromagnetic spectrum, such as jamming and electromagnetic deception, and 2. employment of weapons that use either electromagnetic or directed energy as their primary destructive mechanism (lasers, radio frequency weapons, particle beams), or antiradiation weapons. b. **electronic protection**—That division of electronic warfare involving passive and active means taken to protect personnel, facilities, and equipment from any effects of friendly or enemy employment of electronic warfare that degrade, neutralize or destroy friendly combat capability. Also called **EP**. c. **electronic warfare support**—That division of electronic warfare involving actions tasked by, or under direct control of, an operational commander to search for, intercept, identify, and locate or localize sources of intentional and unintentional radiated electromagnetic energy for the purpose of immediate threat recognition, targeting, planning, and conduct of future operations. Thus, electronic warfare support provides information required for immediate decisions involving electronic warfare operations and other tactical actions such as threat avoidance, targeting, and homing. Also called **ES**. Electronic warfare support data can be used to produce signals intelligence, provide targeting for electronic or destructive attack, and produce measurement and signature intelligence. See also **electromagnetic spectrum**. See FM 34-1.

electronic warfare support – (DOD) That division of electronic warfare involving actions tasked by, or under direct control of, an operational commander to search for, intercept, identify, and locate or localize sources of intentional and unintentional radiated electromagnetic energy for the purpose of immediate threat recognition, targeting, planning, and conduct of future operations. Thus, electronic warfare support provides information required for immediate decisions involving electronic warfare operations and other tactical actions such as threat avoidance, targeting, and homing. Also called **ES**. Electronic warfare support data can be used to produce signals intelligence, provide targeting for electronic or destructive attack, and produce measurement and signature intelligence. See also **electronic warfare**. See FM 34-1.

elicitation – (DOD) Acquisition of information from a person or group in a manner that does not disclose the intent of the interview or conversation. A technique of human source intelligence collection, generally overt, unless the collector is other than he or she purports to be. See FM 34-52.

embarkation – (DOD, NATO) The process of putting personnel and/or vehicles and their associated stores and equipment into ships and/or aircraft. See also **aerial port of embarkation**. See FM 100-17-3.

embarkation order – (DOD, NATO) An order specifying dates, times, routes, loading diagrams, and methods of movement to shipside or aircraft for troops and their equipment. See also **movement table**; **operation order**. See FM 101-5.

embarkation phase – (DOD) In amphibious operations, the phase that encompasses the orderly assembly of personnel and materiel and their subsequent loading aboard ships and/or

aircraft in a sequence designed to meet the requirements of the landing force concept of operations ashore. See also **amphibious force**; **amphibious operation**.

emergency decontamination – See **immediate decontamination**.

emergency procedure – A mandatory procedure that a flight crew must perform to preclude loss of life or injury and to avoid damage to the aircraft when an aircraft malfunction occurs. (FM 3-04.111)

emergency resupply – (DOD) A resupply mission that occurs based on a predetermined set of circumstances and time interval should radio contact not be established or, once established, is lost between a special operations tactical element and its base. See also **automatic resupply**; **on-call resupply**. See FM 100-25.

emergency risk (nuclear) – (DOD) A degree of risk where anticipated effects may cause some temporary shock and casualties and may significantly reduce the unit's combat efficiency. See also **degree of risk**; **negligible risk (nuclear)**. See FM 100-30.

emission security – (DOD) The component of communications security that results from all measures taken to deny unauthorized persons information of value that might be derived from intercept and analysis of compromising emanations from crypto-equipment and telecommunications systems. See also **communications security**. See FM 34-1.

emplacement – (DOD, NATO) 1. A prepared position for one or more weapons or pieces of equipment, for protection against hostile fire or bombardment, and from which they can execute their tasks. 2. The act of fixing a gun in a prepared position from which it may be fired. See FM 6-30. (See page 7-55 for symbol.)

encirclement – (Army) An operation where one force loses its freedom of maneuver because an opposing force is able to isolate it by controlling all ground lines of communications. (FM 3-0) (Marine Corps) The loss of freedom of maneuver resulting from enemy control of all ground routes of evacuation and reinforcement. See also **breakout**; **linkup**. (See page 7-33 for symbols.)

encircling force – (Army/Marine Corps) In pursuit operations, the force which maneuvers to the rear or flank of the enemy to block his escape so that he can be destroyed between the direct pressure force and encircling force. This force advances or flies along routes parallel to the enemy's line of retreat. If the encircling force cannot outdistance the enemy to cut him off, the encircling force may also attack the flank of a retreating enemy. See also **block**; **direct pressure force**; **envelopment**; **pursuit**. See FM 3-90.

endangered species – Those species designated by the Secretary of the Interior that are in danger of extinction throughout all or a significant portion of their range. See also **threatened species**. (FM 3-100.4)

end evening civil twilight – (DOD) The time period when the sun has dropped 6 degrees beneath the western horizon; it is the instant at which there is no longer sufficient light to see objects with the unaided eye. Light intensification devices are recommended from this time until begin morning civil twilight. Also called **EECT**. See also **begin morning civil twilight**; **begin morning nautical twilight**; **end of evening nautical twilight**; **limited visibility operations**. See FM 34-130.

end of evening nautical twilight – (DOD) Occurs when the sun has dropped 12 degrees below the western horizon, and is the instant of last available daylight for the visual control of ground operations. At the end of evening nautical twilight there is no further sunlight available. Also called **EENT**. See also **begin morning civil twilight; begin morning nautical twilight; end evening civil twilight; limited visibility operations**. See FM 34-130.

end of mission – (DOD, NATO) In artillery and naval gunfire support, an order given to terminate firing on a specific target. [Note: the DOD definition also applies to mortar fire.] See also **cease loading; call for fire; fire mission**. See FM 6-20-30.

end state – (DOD) The set of required conditions that defines achievement of the commander's objectives. (Army) At the operational and tactical levels, the conditions that, when achieved, accomplish the mission. At the operational level, these conditions attain the aims set for the campaign or major operation. (Marine Corps) A set of required conditions that, when achieved, attain the aims set for the campaign or operation. See also **commander's intent; operation order**. (FM 3-0)

enemy prisoner of war – An individual or group of individuals detained by friendly forces in any operational environment who meet the criteria as listed in Article 4 of the Geneva Convention Relative to the Handling of Prisoners of War. Also called **EPW**. (FM 34-52)

enfilade fire – Fire delivered on a target in such a manner that the range pattern of the fall of shot generally aligns with the long axis of the target. See also **defilade fire**.

engage – (DOD, NATO) In air defense, a fire control order used to direct or authorize units and/or weapon systems to fire on a designated target. See also **cease fire**. See FM 44-100.

engagement – (DOD) 1. In air defense, an attack with guns or air-to-air missiles by an interceptor aircraft, or the launch of an air defense missile by air defense artillery and the missile's subsequent travel to intercept. 2. A tactical conflict, usually between opposing lower echelon maneuver forces. See also **battle; campaign**. See FM 3-0.

engagement area – An area where the commander intends to contain and destroy an enemy force with the massed effects of all available weapons and supporting systems. Also called **EA**. (FM 3-90) (See page 7-25 for symbol.)

engagement criteria – Protocols that specify those circumstances for initiating engagement with an enemy force. See also **engagement area; decision point**. (FM 3-90)

engagement priority – The order in which the unit engages enemy systems or functions. (FM 3-90)

engineer regulating point – Checkpoint to ensure that vehicles do not exceed the capacity of the crossing means and to give drivers final instructions on site-specific procedures and information, such as speed and vehicle interval. Also called **ERP**. (FM 5-100) (See page 7-55 for symbol.)

engineer work line – A coordinated boundary or phase line used to compartmentalize an area of operations (AO) to indicate where specific engineer units have primary responsibility for the engineer effort. It may be used at division level to discriminate between an AO supported by division engineer assets and an AO supported by direct support or general support corps engineer units. Also called **EWL**. (FM 5-100)

envelopment – (DOD, NATO) An offensive maneuver in which the main attacking force passes around or over the enemy's principal defensive positions to secure objectives to the enemy's rear. (Army) – A form of maneuver in which an attacking force seeks to avoid the principal enemy defenses by seizing objectives to the enemy rear to destroy the enemy in his current positions. At the tactical level, envelopments focus on seizing terrain, destroying specific enemy forces, and interdicting enemy withdrawal routes. See also **turning movement**. (FM 3-0).

environmental area of interest – An environmentally sensitive area that may be deemed worthy of special consideration because of its unique and important qualities relative to adjacent areas (for example, the only forest within a large region), or the importance of its natural environment function (for example, a wetland, flood plains, permafrost area, or an endangered species critical habitat). The environmental area of interest includes man-made structures, such as waste water treatment plants and dams. (FM 3-100.4)

environmental assessment – A study to determine if significant environmental impacts are expected from a proposed action. (FM 3-100.4)

environmental audit – A compliance review of facility operations, practices, and records to assess and verify compliance with federal, state, and local environmental laws and regulations. See also **environmental compliance**. (FM 3-100.4)

environmental base line survey – An assessment or study done on an area of interest (a property) in order to define the environmental state or condition of that property prior to use by US forces. Used to determine the environmental impact of property use by US forces, and the level of environmental restoration needed prior to returning the property upon US departure. (FM 3-100.4)

environmental compliance – The unconditional obeying of international, foreign nation, federal, state, and local environmental rules, regulations, and guidelines that affect current operations. (FM 3-100.4)

environmental conditions report – A concise summary of environmental conditions at a base camp site, based on the environmental base line survey, supported by maps and backup documents, prepared by base camp commanders for each base camp. The environmental conditions report documents conditions at the site if claims or other legal challenges arise against the government. Also called **ECR**. (FM 3-100.4)

environmental considerations – (DOD) The spectrum of environmental media, resources, or programs that may impact on, or are affected by, the planning and execution of military operations. Factors may include, but are not limited to, environmental compliance, pollution prevention, conservation, protection of historical and cultural sites, and protection of flora and fauna. See also **environmental compliance**; **pollution prevention**. See FM 3-100.4.

environmental ethic – Taking care of the environment because it is the right thing to do. This ethic is the operating principle and value that governs individual soldiers, units, and the Army. (FM 3-100.4)

environmental hazards – All activities that may pollute, create negative noise-related effects, degrade archeological/cultural resources, or negatively affect threatened or endangered species habitats. They also include environmental health-related hazards. (FM 3-100.4)

environmental impact statement – Detailed description of the effects, impacts, or consequences associated with designing, manufacturing, testing, operating, maintaining, and disposing of weapon systems or automated information systems. Under the National Environmental Policy Act (NEPA), an environmental impact statement is required when cultural resources may be damaged or significantly adversely affected. (FM 3-100.4)

environmental noise – The outdoor noise environment consisting of all noise (including ambient noise) from all sources that extend beyond, but do not include, the workplace. (FM 3-100.4)

environmental performance assessment system – The examination of an installation's environmental program review to identify possible compliance deficiencies. It also includes designing corrective action plans and implementing fixes for identified deficiencies. Also called **EPAS**. (FM 3-100.4)

environmental planning – Efforts that consider the impact of operation, training, exercises, or weapon system introduction on the environment, and, where necessary, allow decisionmakers to take early action to eliminate or mitigate those impacts. (FM 3-100.4)

environmental pollution – The condition resulting from the presence of chemical, mineral, radioactive, or biological substances that alter the natural environment or that adversely affect human health or the quality of life, biosystems, the environment, structures and equipment, recreational opportunities, aesthetics, or natural beauty. (FM 3-100.4)

environmental protection – The application of human ingenuity and resources, through the disciplines of science and engineering, as required by environmental protection laws, regulations, and policies, to protect the natural environment. (FM 3-100.4)

environmental protection level – The varying level of environmental protection that can reasonably be afforded at any particular time during warfare or battlefield conditions, given the absolute requirement that such a diversion of resources away from the mission at hand does not adversely affect that mission, or any friendly personnel, or indigenous or refugee populations. (FM 3-100.4)

environmental reconnaissance – The systematic observation and recording of site or area data collected by visual or physical means, dealing specifically with environmental conditions as they exist, and identifying areas that are environmentally sensitive or of relative environmental concern, for information and decisionmaking purposes. (FM 3-100.4)

environmental services – (DOD) The various combinations of scientific, technical, and advisory activities (including modification processes, i.e., the influence of manmade and natural factors) required to acquire, produce, and supply information on the past, present, and future states of space, atmospheric, oceanographic, and terrestrial surroundings for use in military planning and decisionmaking processes or to modify those surroundings to enhance military operations. See FM 3-100.4.

environmental stewardship – (DOD) The integration and application of environmental values into the military mission in order to sustain readiness, improve quality of life, strengthen civil relations and preserve valuable natural resources. See FM 3-100.4.

escort – (DOD, NATO) 1. A combatant unit(s) assigned to accompany and protect another force or convoy. 2. Aircraft assigned to protect other aircraft during a mission. See FM 3-04.111. 3. An armed guard that accompanies a convoy, a train, prisoners, etc. 4. An armed guard

accompanying persons as a mark of honor. 5. (DOD only) To convoy. 6. A member of the Armed Forces assigned to accompany, assist, or guide an individual or group, e.g., an escort officer. See FM 3-07.

essential elements of friendly information – (DOD) Key questions likely to be asked by adversary officials and intelligence systems about specific friendly intentions, capabilities, and activities so they can obtain answers critical to their operational effectiveness. (Army) The critical aspects of a friendly operation that, if known by the enemy, would subsequently compromise, lead to failure, or limit success of the operation, and, therefore, must be protected from enemy detection. (FM 3-13) (Marine Corps) Specific facts about friendly intentions, capabilities, and activities needed by adversaries to plan and execute effective operations against our forces. Also called **EEFI**. See also **commander's critical information requirements**.

essential task – A task that must be executed to accomplish the mission. See also **implied task**; **specified task**. (FM 101-5)

evacuation – (DOD) 1. The process of moving any person who is wounded, injured, or ill to and/or between medical treatment facilities. [Note: the Army definition adds “using non-standard platforms.”] See FM 8-10-6. 2. The clearance of personnel, animals, or materiel from a given locality. 3. The controlled process of collecting, classifying, and shipping unserviceable or abandoned materiel, US or foreign, to appropriate reclamation, maintenance, technical intelligence, or disposal facilities. 4. The ordered or authorized departure of noncombatants from a specific area by the Department of State, Department of Defense, or appropriate military commander. This refers to the movement from one area to another in the same or different countries. The evacuation is caused by unusual or emergency circumstances and applies equally to command or non-command sponsored family members. See FM 3-07. (Army) A combat service support function that involves the movement of recovered materiel, personnel, casualties, bodies, prisoners of war, and so forth from a forward collection point along a main supply route to a rearward, usually higher unit, exchange point, or facility. (FM 4-0) See also **noncombatant evacuation operation**.

evacuation force – Element of joint task force that conducts in-country evacuation operations, including advance party, evacuation control center, marshalling, and force protection operations. See also **evacuation**. (FM 3-07)

evacuation site – Location, selected by the embassy and occupied by the evacuation force, where evacuees are consolidated and prepared for evacuation. It is usually located near the point of embarkation. See also **evacuation**. (FM 3-07)

evaluate – An element of assessment: To compare relevant information on the situation or operation against criteria to judge success or progress. (FM 6-0)

evasion and escape – (DOD, NATO) The procedures and operations whereby military personnel and other selected individuals are enabled to emerge from an enemy-held or hostile area to areas under friendly control. Also called **E&E**. See FM 100-25.

evasion and recovery – (DOD) The full spectrum of coordinated actions carried out by evaders, recovery forces, and operational recovery planners to effect the successful return of personnel isolated in hostile territory to friendly control. Also called **E&R**. See also **hostile**. See FM 3-05.20.

event template – (DOD) A guide for collection planning. The event template depicts the named area of interest where activity, or its lack of activity, will indicate which course of action the adversary has adopted. (Army) A model against which enemy activity can be recorded and compared. It represents a sequential projection of events that relate to space and time on the battlefield and indicate the enemy’s ability to adopt a particular course of action. The event template is a guide for collection and reconnaissance and surveillance planning. See also **area of interest; course of action; decision support template; doctrinal template; named area of interest; situation template**. (FM 34-1)

exclusive standoff zone – A controlled area surrounding a facility in which only service and delivery vehicles are allowed. The perimeter of this area is defined by barriers and is set at a standoff distance sufficient to reduce the blast effects of a vehicle bomb. (FM 5-100)

execute – To put a plan into action by applying combat power to accomplish the mission and using situational understanding to assess progress and make execution and adjustment decisions. (FM 6-0)

execution decisions – The selection, during preparation and execution, of a course of action anticipated by the order. (FM 6-0)

execution information – Information that communicates a decision and directs, initiates, or governs action, conduct, or procedure. (FM 6-0)

execution matrix – A visual and sequential representation of the critical tasks and responsible organizations by phase for a tactical operation. (FM 101-5)

exempt – A procedure word meaning, “The addressees immediately following are exempted from the collective call.” See also **procedure word**. (FM 24-19)

exercise – (DOD, NATO) A military maneuver or simulated wartime operation involving planning, preparation, and execution. It is carried out for the purpose of training and evaluation. It may be a multinational [Note: the NATO definition replaces “multinational” with “combined”], joint, or single-Service exercise, depending on participating organizations. See also **command post exercise; field exercise; maneuver**. See FM 7-0.

exfiltration – (DOD) The removal of personnel or units from areas under enemy control by stealth, deception, surprise, or clandestine means. See also **special operations; unconventional warfare**. See FM 3-90.

expedient flight route – Flight route that is established with preselected and disseminated checkpoints. For a specific mission, the commander can define an expedient flight route by reference to these checkpoints when limited time is available to develop and disseminate pickup and landing zones and flight route information. (FM 3-04.111)

expeditionary force – (DOD) An armed force organized to accomplish a specific objective in a foreign country.

exploit – In information operations, to gain access to adversary command and control systems to collect information or to plant false or misleading information. (FM 3-13)

exploitation – (DOD, NATO) 1. Taking full advantage of success in military operations [Note: the NATO definition replaces “military operations” with “battle”], following up initial gains, [Note: the NATO definition ends here] and making permanent the temporary effects already

achieved. See FM 3-0. 2. Taking full advantage of any information that has come to hand for tactical, operational, or strategic purposes. See FM 3-13. 3. An offensive operation that usually follows a successful attack and is designed to disorganize the enemy in depth. See FM 3-0. See also **attack**; **pursuit**.

explosive ordnance disposal – (DOD, NATO) The detection, identification, on-site evaluation, rendering safe, recovery, and final disposal of unexploded explosive ordnance. It may also include explosive ordnance which has become hazardous by damage or deterioration. Also called **EOD**. See FM 5-250.

exposure – The frequency and length of time subjected to a hazard. (FM 100-14)

exposure dose – (DOD, NATO) The exposure dose at a given point is a measurement of radiation in relation to its ability to produce ionization. The unit of measurement of the exposure dose is the roentgen. [Note: the Army also uses centigray per hour/cGyph or gray per hour/Gyph as units of measurement.] See also **absorbed dose**; **dose rate**. See FM 3-3-1.

exterior lines – A force operates on exterior lines when its operations converge on the enemy. (FM 3-0)

extraction zone – (DOD, NATO) A specified drop zone used for the delivery of supplies and/or equipment by means of an extraction technique from an aircraft flying very close to the ground. Also called **EZ**. See also **air assault**; **airborne operation**; **airhead line**. See FM 90-26. (See page 7-17 for symbol.)

—F—

fallout – (DOD) The precipitation to Earth of radioactive particulate matter from a nuclear cloud; also applied to the particulate matter itself. See also **downwind hazard area**; **radiation dose**; **radiation dose rate**; **radiation status**. See FM 3-3-1.

family of scatterable mines – A grouping of munitions that dispenses scatterable mines (scatmines) by artillery, helicopter, fixed wing, or ground launchers. There are antipersonnel and antitank mines. Also called **FASCAM**. See also **minefield**; **scatterable mines**. (FM 20-32)

fascines – Large cylindrical bundles of material, usually wooden poles or plastic or metal pipe loosely bound together, which are dropped into ditches or gaps to create crossings. See also **block**; **obstacle**. (FM 3-34.2)

feature – (NATO) In cartography, any object or configuration of ground or water represented on the face of the map or chart. See FM 3-25.26.

feedback – In information operations, information that reveals how the deception target is responding to the deception story and if the military deception plan is working. See also **deception target**. (FM 3-13)

feint – (DOD) In military deception, an offensive action involving contact with the adversary conducted for the purpose of deceiving the adversary as to the location and/or time of the actual main offensive action. (Army) A form of attack used to deceive the enemy as to the location or time of the actual decisive operation. Forces conducting a feint seek direct fire contact with the enemy but avoid decisive engagement. (FM 3-0) (Marine Corps) A limited-objective attack involving contact with the enemy, varying in size from a raid to a supporting attack. Feints are used to cause the enemy to react in three predictable ways: to employ

reserves improperly, to shift supporting fires, or to reveal defensive fires. See also **attack; deception; demonstration; display; ruse**. (See page 7-23 for symbol.)

F-hour – (DOD) The effective time of announcement by the Secretary of Defense to the Military Departments of a decision to mobilize Reserve units. See also **times**. See FM 101-5.

field artillery survey – The element of an artillery unit that determines an exact location and marks it as a point of reference for laying in the artillery unit. (FM 6-2)

field control – (NATO) A series of points whose relative positions and elevations are known. These positions are used in basic data in mapping and charting. Normally these positions are established by survey methods, and are sometimes referred to as trig control or trigonometric net(work). See also **control point**. See FM 3-34.331

field exercise – (DOD, NATO) An exercise conducted in the field under simulated war conditions in which troops and armament of one side are actually present, while those of the other side may be imaginary or in outline. See also **command post exercise**. See FM 7-0.

field force engineering – The application of the engineer regiment's capabilities across the range of engineer battlespace functions (although primarily general engineering intensive) and in all phases of operations (offense, defense, stability, and support) through both reach and forward presence. Also called **FFE**. (FM 5-100)

field fortifications – (DOD, NATO) An emplacement or shelter of a temporary nature which can be constructed with reasonable facility by units requiring no more than minor engineering supervisory and equipment participation. See also **battle position; emplacement; strong point**. See FM 5-103.

field of fire – (DOD, NATO) The area which a weapon or a group of weapons may cover effectively with fire from a given position. See also **dead space; defilade fire; enfilade fire intelligence preparation of the battlefield**. See FM 3-90.

field services – Essential services to enhance a soldier's quality of life during operations. They consist of clothing exchange, laundry and shower support, textile repair, mortuary affairs, preparation for aerial delivery, food services, billeting, and sanitation. (FM 4-0)

field trains – The combat service support portion of a unit at company, battalion, and brigade level that is positioned in the brigade support area with the forward support battalion and other support elements pushed forward from the division main support battalion. See also **combat trains; unit trains**. (FM 63-2)

field trains command post – At the battalion and squadron levels, the place from which the headquarters and headquarters company/headquarters and headquarters troop commander controls the field trains operations. Also called **FTCP**. (FM 7-20)

fighter engagement zone – (DOD) In air defense, that airspace of defined dimensions within which the responsibility for engagement of air threats normally rests with fighter aircraft. Also called **FEZ**. See also **weapon engagement zone**. See FM 3-52.

fighting patrol – See **combat patrol**.

figures – A procedure word meaning, "Numerals or numbers follow." See also **procedure word**. (FM 24-19)

final coordination line – (Army) A phase line close to the enemy position used to coordinate the lifting or shifting of supporting fires with the final deployment of maneuver elements. (FM 3-90) (Marine Corps) A line used to coordinate the ceasing and shifting of supporting fires and the final deployment of the assault echelon in preparation for launching an assault against an enemy position. Also called **FCL**. See also **assault**. (See page 7-30 for symbol.)

final protective fire – (DOD, NATO) An immediately available prearranged barrier of fire designed to impede enemy movement across defensive lines or areas. Also called **FPF**. See also **battle position**; **final protective line**. See FM 3-90. (See page 7-39 for symbol.)

final protective line – A line of fire selected where an enemy assault is to be checked by interlocking fire from all available weapons and obstacles. [Note: the Marine Corps definition adds “A final protective line may be parallel with, or oblique to, the front of the position.”]. Also called **FPL**. See also **dead space**; **field of fire**; **final protective fire**; **principal direction of fire**. (FM 6-30) (See page 7-24 for symbol.)

fire – (DOD, NATO) 1. The command given to discharge a weapon(s). See FM 6-50. 2. To detonate the main explosive charge by means of a firing system. See FM 5-250. See also **barrage fire**; **call for fire**; **counterfire**; **counterpreparation fire**; **covering fire**; **destruction fire**; **direct fire**; **grazing fire**; **harassing fire**; **indirect fire**; **neutralization fire**; **observed fire**; **preparation fire**; **registration fire**; **scheduled fire**.

fire and movement – (Army) The concept of applying fires from all sources to suppress, neutralize, or destroy the enemy, and the tactical movement of combat forces in relation to the enemy (as components of maneuver, applicable at all echelons). At the squad level, it entails a team placing suppressive fire on the enemy as another team moves against or around the enemy. (FM 7-30) (Marine Corps) A technique primarily used in the assault wherein a unit or element advances by bounds or rushes, with subelements alternately moving and providing covering fire for other moving subelements. Fire and movement may be done by individuals (personnel or vehicles) or units (such as fire teams or squads). Usually, fire and movement is used only when under effective fire from the enemy because it is relatively slow and difficult to control. See also **bounding overwatch**; **formation**; **support by fire**.

fire base – An area used during air assault operations from which a unit is moved via helicopters and supports the air assault operation’s main effort with direct or indirect fires. (FM 90-4)

fire command – A specific sequence of information given by a control authority that causes a crew to begin performing a sequence of actions and provides detailed direction to choose the ammunition type, aim the weapon, and engage the target. Each element given by the controller requires a response from a crewmember to ensure correct aiming and engagement. After the initial fire command, subsequent fire commands using the same sequence of information can be used to adjust the point of impact to ensure the desired target effect. (FM 6-50)

fire direction center – (DOD, NATO) That element of a command post, consisting of gunnery and communication personnel and equipment, by means of which the commander exercises fire direction and/or fire control. The fire direction center receives target intelligence and requests for fire, and translates them into appropriate fire direction. The fire direction center provides timely and effective tactical and technical fire control in support of current operations. [Note: the NATO definition replaces the last sentence with “The fire direction

center receives target intelligence and requests for fire and translates them into appropriate fire direction.”] Also called **FDC**. See FM 6-40.

fire for effect – (DOD) That volume of fires delivered on a target to achieve the desired effect. (NATO) 1. Fire which is delivered after the mean point of impact or burst is within the desired distance of the target or adjusting/ranging point. 2. Term in a call for fire to indicate the adjustment/ranging is satisfactory and fire for effect is desired. Also called **FFE**. See also **call for fire; destroy; final protective fire; fire mission; neutralize; suppression**. See FM 6-30.

fire mission – (DOD, NATO) 1. Specific assignment given to a fire unit as part of a definite plan. 2. Order used to alert the weapon/battery area and indicate that the message following is a call for fire. See also **call for fire; cease loading; fire support element**. See FM 6-30.

fire plan – (DOD, NATO) A tactical plan for using the weapons of a unit or formation so that their fire will be coordinated. See also **air defense; final protective fire; fire support; offensive operations**. See FM 6-20-10.

firepower – (DOD, NATO) 1. The amount of fire which may be delivered by a position, unit, or weapon system. 2. Ability to deliver fire. See also **combat power; fire plan; mission, enemy, terrain, troops, time available, and civil considerations**. See FM 3-0.

fires – (DOD) The effects of lethal or nonlethal weapons. See FM 6-20.

fire strike – The massed, synchronized, and nearly simultaneous delivery of precision-guided munitions. (FM 3-90)

fire superiority – The degree of dominance in the fires of one force over another that permits that force to conduct maneuver at a given time and place without prohibitive interference by the enemy. (FM 3-90)

fire support – (DOD) Fires that directly support land, maritime, amphibious, and special operations forces to engage enemy forces, combat formations, and facilities in pursuit of tactical and operational objectives. See FM 3-0. (Marine Corps) In Marine Corps usage, assistance to elements of the Marine air-ground task force engaged with the enemy rendered by other firing units, including (but not limited to) artillery, mortars, naval surface fire support, and offensive air support. See also **combined arms; fire support plan**.

fire support area – (DOD) An appropriate maneuver area assigned to fire support ships by the naval force commander from which they can deliver gunfire support to an amphibious operation. Also called **FSA**. See also **amphibious operation; fire support; fire support station; naval gunfire support**. See FM 6-20-30. (See page 7-37 for symbol.)

fire support battlefield operating system – (Army) Encompasses the collective and coordinated use of target-acquisition data, indirect fire weapons, fixed-wing aircraft, offensive information operations, and other lethal and nonlethal means against targets located throughout an area of operations. See also **battlefield operating systems**. (FM 7-15)

fire support coordinating measure – (DOD) A measure employed by land or amphibious commanders to facilitate the rapid engagement of targets and simultaneously provide safeguards for friendly forces. See also **fire support coordination**. See FM 6-20-10.

fire support coordination – (DOD, NATO) The planning and executing of fire so that targets are adequately covered by a suitable weapon or group of weapons. See also **fire support coordinating measure**. See FM 6-20-10.

fire support coordination line – (DOD) A fire support coordinating measure that is established and adjusted by appropriate land or amphibious force commanders within their boundaries in consultation with superior, subordinate, supporting, and affected commanders. Fire support coordination lines (FSCLs) facilitate the expeditious attack of surface targets of opportunity beyond the coordinating measure. An FSCL does not divide the area of operations by defining a boundary between close and deep operations or a zone for close air support. The FSCL applies to all fires of air, land, and sea-based weapons systems using any type of ammunition. Forces attacking targets beyond an FSCL must inform all affected commanders in sufficient time to allow necessary reaction to avoid fratricide. Supporting elements attacking targets beyond the FSCL must ensure that the attack will not produce adverse effects on, or to the rear of, the line. Short of an FSCL, all air-to-ground and surface-to-surface attack operations are controlled by the appropriate land or amphibious force commander. The FSCL should follow well-defined terrain features. Coordination of attacks beyond the FSCL is especially critical to commanders of air, land, and special operations forces. In exceptional circumstances, the inability to conduct this coordination will not preclude the attack of targets beyond the FSCL. However, failure to do so may increase the risk of fratricide and could waste limited resources. (NATO) Within an assigned area of operations, a line established by a land or amphibious force commander to denote coordination requirements for fires by other force elements which may affect the commander's current and planned operations. The fire support coordination line applies to fires of air, ground or sea weapons using any type of ammunition against surface or ground targets. The establishment of the fire support coordination line must be coordinated with the appropriate commanders and supporting elements. Attacks against surface or ground targets short of the fire support coordination line must be conducted under the positive control or procedural clearance of the associated land or amphibious force commander. Unless in exceptional circumstances, commanders of forces attacking targets beyond the fire support coordination line must coordinate with all affected commanders in order to avoid fratricide and to harmonize joint objectives. Note: in the context of this definition, the term "surface targets" applies to those in littoral or inland waters within the designated area of operations. Also called **FSCL**. See also **boundary; coordinated fire line; fires; fire support; fire support coordinating measure**. See FM 6-20-10. (See page 7-36 for symbol.)

fire support coordinator – (Marine Corps) The officer in charge of the fire support coordination center. He is the direct representative of the landing force commander for the planning and coordination of all available fire support. Also called **FSC**.

fire support element – (DOD) That portion of the force tactical operations center at every echelon above company or troop (to corps) that is responsible for targeting coordination and for integrating fires delivered on surface targets by fire support means under the control, or in support, of the force. Also called **FSE**. See also **fire; fire support; support**. See FM 6-40.

fire support officer – (DOD) Senior field artillery officer assigned to Army maneuver battalions and brigades. Advises commander on fire support matters. See also **fire support**. See FM 6-20.

fire support plan – A plan on how indirect fires and target acquisition will be used to support an operation. It should include a portion for each means of fire support involved. See also

counterfire; fire support; fire support coordination; list of targets; operation order. (FM 6-20-10)

fire support station – (DOD) An exact location at sea within a fire support area from which a fire support ship delivers fire. Also called **FSS**. See also **fire support area; naval gunfire support**. See FM 6-20-30. (See page 7-36 for symbol.)

fire support targets – Geographical points or objects that are aiming points for fire support systems. There are point targets, rectangular targets, and linear targets. (FM 3-90)

fire support team – (DOD) An Army team provided by the field artillery component to each maneuver company and troop to plan and coordinate all indirect fire means available to the unit, including mortars, field artillery, close air support, and naval gunfire. Also called **FIST**. See also **air support; fire; fire support; fire support element**. See FM 6-20-20.

firing circuit – (DOD) 1. In land operations, an electrical circuit and/or pyrotechnic loop designed to detonate connected charges from a firing point. See FM 5-250. 2. In naval mine warfare, that part of a mine circuit which either completes the detonator circuit or operates a ship counter.

first destination reporting point – A point manned by a movement regulating team, a movement control team, or military police that diverts a driver and cargo to an alternate consignee or destination. Also called **FDRP**. (FM 4-01.30)

fix – (DOD, NATO) A position determined from terrestrial, electronic, or astronomical data. (Army) 1. A tactical mission task where a commander prevents the enemy from moving any part of his force from a specific location for a specific period of time. 2. An engineer obstacle effect that focuses fire planning and obstacle effort to slow an attacker's movement within a specified area, normally an engagement area. See also **block; contain; disrupt; support by fire; turn; way point**. (FM 3-90) (See pages 7-49 and A-3 for symbol.)

flank – The right or left limit of a unit. (FM 3-90)

flank guard – (DOD, NATO) A security element operating to the flank of a moving or stationary force to protect it from enemy ground observation, direct fire, and surprise attack. See also **screen; security operation**. See FM 3-90.

flash – A procedure word meaning, "Precedence, FLASH." Reserved for initial enemy contact reports on special emergency operational combat traffic originated by specifically designated high commanders of units directly affected. This traffic is to be **SHORT** reports of emergency situations of vital proportions. Handling is as fast as humanely possible with an objective time of 10 minutes or less. See also **procedure word**. (FM 24-19)

flash blindness – (DOD, NATO) Impairment of vision resulting from an intense flash of light. It includes temporary or permanent loss of visual functions and may be associated with retinal burns. See also **dazzle**. See FM 100-30.

flight coordination center – A primary Army air traffic control agency that is subordinate to the flight operations center (FOC). It provides flight following as well as information on air traffic movement within its assigned area; monitors Army aircraft operations and provides hostile activity warnings to Army aviation units operating in the airspace; passes instrument flight rules flight plans to the airspace management center for approval and visual flight rules flight plans to the appropriate air traffic services facility; establishes liaison with the

air defense command post; and provides a communications link between terminal facilities of existing airfields, other nearby airfields, division command posts, other flight coordination centers, and the FOC when the flight coordination center locates in a division area. Also called **FCC**. (FM 3-04.111)

flight corridor – See **air corridor**.

flight following – (DOD, NATO) The task of maintaining contact with specified aircraft for the purpose of determining en route progress and/or flight termination. See also **air control point**; **air corridor**; **communications checkpoint**. See FM 3-04.111.

flight liaison officer – A member of the tactical air control party. He is responsible to the corps air liaison officer and provides specific knowledge and expertise on the employment of fighter attack aircraft. Also called **FLO**. (FM 3-04.111)

flight operations center – The element of the tactical Army air traffic regulation system which provides for aircraft flight following, separation of aircraft under instrument conditions, and identification of friendly aircraft to friendly air defense agencies. Also called **FOC**. (FM 3-04.111)

float – Logistics support that provides major assembly replacement for a piece of equipment which is repairable but will take an extraordinary amount of time to repair. (FM 4-30.3)

follow and assume – (Army) A tactical mission task in which a second committed force follows a force conducting an offensive operation and is prepared to continue the mission if the lead force is fixed, attrited, or unable to continue. See also **attack**; **offensive operations**. (FM 3-90) (See page A-4 for symbol.)

follow and support – A tactical mission task in which a committed force follows and supports a lead force conducting an offensive operation. See also **direct pressure force**; **encircling force**; **exploitation**; **pursuit**. (FM 3-90) (See page A-4 for symbol.)

follow-on echelon – (NATO) In amphibious operations, that echelon of the assault troops, vehicles, aircraft equipment, and supplies which, though not needed to initiate the assault, is required to support and sustain the assault. (Army) Those additional forces moved into the objective area after the assault echelon. (FM 3-90) See also **air assault operation**; **assault echelon**.

follow-on forces – All enemy ground forces not committed during their offensive operations to the contact battle, their command and control installations, and their logistic and other support provided for sustained operations. (FM 3-90)

foot march – See **dismounted march**.

footprint – (DOD) 1. The area on the surface of the earth within a satellite's transmitter or sensor field of view. 2. The amount of personnel, spares, resources, and capabilities present and occupying space at a deployed location.

force health protection – (DOD) All services performed, provided, or arranged by the Services to promote, improve, conserve, or restore the mental or physical well being of personnel. These services include, but are not limited to, the management of health service resources, such as manpower, monies, and facilities; preventive and curative health measures; medical evacuation of the wounded, injured or sick; selection of the medically fit and disposition of

the medically unfit; blood management; medical supply, equipment, and maintenance thereof; combat stress control; and medical, dental, veterinary, laboratory, optometry, medical food, and medical intelligence services. See FM 3-100.4.

force projection – (DOD) The ability to project the military element of national power from the continental United States (CONUS) or another theater in response to requirements for military operations. Force projection operations extend from mobilization and deployment of forces to redeployment to CONUS or home theater. See FM 3-0.

force protection – (DOD) Actions taken to prevent or mitigate hostile actions against Department of Defense personnel (to include family members), resources, facilities, and critical information. These actions conserve the force's fighting potential so it can be applied at a decisive time and place and incorporates the coordinated and synchronized offensive and defensive measures to enable the effective employment of the joint force while degrading opportunities for the enemy. Force protection does not include actions to defeat the enemy or protect against accidents, weather, or disease. Also called **FP**. See also **protection**. See FM 3-0.

force protection condition – (DOD) A Chairman of the Joint Chiefs of Staff-approved program standardizing the Military Services' identification of and recommended responses to terrorist threats against US personnel and facilities. This program facilitates inter-Service coordination and support for antiterrorism activities. Also called **FPCON**. There are four FPCONs above normal. a. **FPCON ALPHA**—This condition applies when there is a general threat of possible terrorist activity against personnel and facilities, the nature and extent of which are unpredictable, and circumstances do not justify full implementation of FPCON BRAVO measures. However, it may be necessary to implement certain measures from higher FPCONs resulting from intelligence received or as a deterrent. The measures in this FPCON must be capable of being maintained indefinitely. b. **FPCON BRAVO**—This condition applies when an increased and more predictable threat of terrorist activity exists. The measures in this FPCON must be capable of being maintained for weeks without causing undue hardship, affecting operational capability, and aggravating relations with local authorities. c. **FPCON CHARLIE**—This condition applies when an incident occurs or intelligence is received indicating some form of terrorist action against personnel and facilities is imminent. Implementation of measures in this FPCON for more than a short period probably will create hardship and affect the peacetime activities of the unit and its personnel. d. **FPCON DELTA**—This condition applies in the immediate area where a terrorist attack has occurred or when intelligence has been received that terrorist action against a specific location or person is likely. Normally, this FPCON is declared as a localized condition. See also **force protection; terrorism**.

force tailoring – The process of determining the right mix and sequence of units for a mission. (FM 3-0)

force tracking – (DOD) The identification of units and their specific modes of transport during movement to an objective area. See FM 3-0.

ford – A shallow part of a body of water or wet gap that can be crossed without bridging, boats, ferries, or rafts. It is a location in a water barrier where the physical characteristics of current, bottom, and approaches permit the passage of personnel, vehicles, and other equipment where the wheels or tracks remain in contact with the bottom at all times. See also **gap; reconnaissance; river crossing**. (FM 90-13) (See page 7-54 for symbol.)

foreign humanitarian assistance – (DOD) Programs conducted to relieve or reduce the results of natural or manmade disasters or other endemic conditions such as human pain, disease, hunger, or privation that might present a serious threat to life or that can result in great damage to or loss of property. Foreign humanitarian assistance (FHA) provided by US forces is limited in scope and duration. The foreign assistance provided is designed to supplement or complement the efforts of the host nation civil authorities or agencies that may have primary responsibility for providing FHA. FHA operations are those conducted outside the United States, its territories, and possessions. Also called **FHA**. See FM 3-0.

foreign instrumentation signals intelligence – (DOD) Technical information and intelligence derived from the intercept of foreign electromagnetic emissions associated with the testing and operational deployment of non-US aerospace, surface, and subsurface systems. Foreign instrumentation signals intelligence is a subcategory of signals intelligence. Foreign instrumentation signals include but are not limited to telemetry, beaconry, electronic interrogators, and video data links. Also called **FISINT**. See also **signals intelligence**. See FM 34-2.

foreign internal defense – (DOD) Participation by civilian and military agencies of a government in any of the action programs taken by another government to free and protect its society from subversion, lawlessness, and insurgency. Also called **FID**. See FM 3-07.

formation – (DOD, NATO) 1. An ordered arrangement of troops and/or vehicles for a specific purpose. 2. An ordered arrangement of two or more ships, units, or aircraft proceeding together under a commander. See FM 3-04.111.

forms of maneuver – Distinct tactical combinations of fire and movement with a unique set of doctrinal characteristics that differ primarily in the relationship between the maneuvering force and the enemy. The choices of offensive maneuver are envelopment, turning movement, infiltration, penetration, and frontal attack. The choices of defensive maneuver are forward and in-depth. Commanders use these to orient on the enemy, not terrain. More than one may be applied during an operation and may be used in conjunction with a form of tactical operations. See also **attack**; **envelopment**; **frontal attack**; **infiltration**; **penetration**; **turning movement**. (FM 3-0)

forms of uncertainty – In military deception, means of shaping the deception target's perception. Increasing uncertainty aims to confuse the deception target. Reducing uncertainty aims to reinforce the deception target's predisposition. See also **deception target**. (FM 3-13)

forward area air defense engagement zone – An area of forward area air defense (FAAD) deployment that may fall within a missile engagement zone. It is also possible that some areas may be solely defended by FAAD assets. A forward area air defense engagement zone can be established to define the airspace within which these assets will operate. Because centralized control over short-range air defense weapons may not be possible, these areas must be clearly defined and promulgated so that friendly aircraft can avoid them. Also called **FAADEZ**. (FM 44-100) (See page 7-20 for symbol.)

forward arming and refueling point – (DOD) A temporary facility—organized, equipped, and deployed by an aviation commander, and normally located in the main battle area closer to the area where operations are being conducted than the aviation unit's combat service support area—to provide fuel and ammunition necessary for the employment of aviation maneuver units in combat. The forward arming and refueling point permits combat aircraft

to rapidly refuel and rearm simultaneously. Also called **FARP**. See FM 3-04.111. (See page 7-70 for symbol.)

forward assembly area – A temporary area where aviation units gather to prepare for a mission that is forward of the aviation brigade’s assembly area and airfield, but not as far forward as the attack position. Aircraft may be in the forward assembly area for short or long duration based on METT-TC. [Note: the Marine Corps uses METT-T.] Also called **FAA**. (FM 3-04.111)

forward edge of the battle area – (DOD, NATO) The foremost limits of a series of areas in which ground combat units are deployed, excluding the areas in which the covering or screening forces are operating, designated to coordinate fire support, the positioning of forces, or the maneuver of units. Also called **FEBA**. See also **main battle area**. See FM 3-90. (See page 7-24 for symbol.)

forward line of own troops – (DOD) A line which indicates the most forward positions of friendly forces in any kind of military operation at a specific time. The forward line of own troops (FLOT) normally identifies the forward location of covering and screening forces. The FLOT may be at, beyond, or short of the forward edge of the battle area. An enemy FLOT indicates the forward-most position of hostile forces. Also called **FLOT**. See FM 3-90. (See page 7-13 for symbol.)

forward logistics base – The area occupied by multifunctional forward logistics elements of a support battalion, group, or command when it echelons its assets to provide critical support to combat forces. The base may be the first stage of the development of the support area. Also called **FLB**. (FM 4-0)

forward logistics element – A multifunctional logistics element task-organized to support fast-moving offensive operations, early phases of contingency operations, and units geographically separated from normal support channels. The forward logistics element operates out of a forward logistics base. Also called **FLE**. (FM 4-0)

forward observer – (DOD) An observer operating with front line troops and trained to adjust ground or naval gunfire and pass back battlefield information. In the absence of a forward air controller, the observer may control close air support strikes. Also called **FO**. See FM 6-30.

forward operations base – (DOD) In special operations, a base usually located in friendly territory or afloat that is established to extend command and control or communications or to provide support for training and tactical operations. Facilities may be established for temporary or longer duration operations and may include an airfield or an unimproved airstrip, an anchorage, or a pier. A forward operations base may be the location of special operations component headquarters or a smaller unit that is controlled and/or supported by a main operations base. [Note: ARMY SOF term is “forward operational base.”] See also **advanced operations base**; **main operations base**. See FM 100-25.

forward passage of lines – When a unit passes through another unit’s positions while moving toward the enemy. (FM 3-90)

forward tell – (DOD, NATO) The transfer of information to a higher level of command. See also **track telling**.

fragmentary order – (DOD) An abbreviated form of an operation order (verbal, written, or digital) usually issued on a day-to-day basis that eliminates the need for restating information contained in a basic operation order. It may be issued in sections. It is issued after an operation order to change or modify that order or to execute a branch or sequel to that order. Also called **FRAG order/FRAGO**. See FM 101-5.

fratricide – The unintentional killing or wounding of friendly personnel by friendly firepower. (FM 3-0)

free fire area – (DOD) A specific area into which any weapon system may fire without additional coordination with the establishing headquarters. Also called **FFA**. See also **fire**; **fire support coordination**; **rules of engagement**. See FM 3-90. (See page 7-37 for symbol.)

friendly – (DOD) A contact positively identified as friendly. See also **hostile**. (Army) A track or contact belonging to a declared friendly nation. (FM 1-02) (See page 4-3 for symbol.)

friendly fire – (DOD) In casualty reporting, a casualty circumstance applicable to persons killed in action or wounded in action mistakenly or accidentally by friendly forces actively engaged with the enemy, who are directing fire at a hostile force or what is thought to be a hostile force. See also **casualty**; **fratricide**. See FM 3-0.

friendly force information requirements – (Army) Information the commander and staff need about the forces available for the operation. (FM 6-0) (Marine Corps) Information the commander needs about friendly forces in order to develop plans and make effective decisions. Depending upon the circumstances, information on unit location, composition, readiness, personnel status, and logistics status could become a friendly force information requirement. Also called **FFIR**. See also **commander's critical information requirements**.

from – A procedure word meaning, “The originator of this message is indicated by the address designation immediately following.” See also **procedure word**. (FM 24-19)

front – (DOD, NATO) 1. The lateral space occupied by an element measured from the extremity of one flank to the extremity of the other flank. 2. The direction of the enemy. 3. The line of contact of two opposing forces. 4. When a combat situation does not exist or is not assumed, the direction toward which the command is faced. See also **forward edge of the battle area**; **forward line of own troops**. See FM 3-90.

frontal attack – (DOD, NATO) 1. An offensive maneuver in which the main action is directed against the front of the enemy forces. 2. (DOD only) In air intercept, an attack by an interceptor aircraft that terminates with a heading crossing angle greater than 135 degrees. See FM 3-04.111. (Army) A form of maneuver in which the attacking force seeks to destroy a weaker enemy force or fix a larger enemy force in place over a broad front. (FM 3-0) See also **assault**; **form of maneuver**; **offensive operations**.

full command – (NATO) The military authority and responsibility of a commander to issue orders to subordinates. It covers every aspect of military operations and administration and exists only within national services. [Note: the term “command” as used internationally implies a lesser degree of authority than when it is used in a purely national sense. No NATO or coalition commander has full command over the forces assigned to him since, in assigning forces to NATO, nations will delegate only operational command or operational

control.] See also **administrative control**; **operational command**; **operational control**. See FM 6-0.

full mission-capable – (DOD) Material condition of any piece of military equipment, aircraft, or training device indicating that it can perform all missions. Also called **FMC**. See also **deadline**. See FM 4-30.3.

full mobilization – (DOD) Expansion of the active Armed Forces resulting from action by Congress and the President to mobilize all Reserve component units in the existing approved force structure, all individual reservists, retired military personnel, and the resources needed for their support to meet the requirements of a war or other national emergency involving an external threat to the national security. Reserve personnel can be placed on active duty for the duration of the emergency plus six months. See also **mobilization**. See FM 100-17.

full spectrum operations – The range of operations Army forces conduct in war and military operations other than war. (FM 3-0)

functional component command – (DOD) A command normally, but not necessarily, composed of forces of two or more Military Departments which may be established across the range of military operations to perform particular operational missions that may be of short duration or may extend over a period of time. See also **command relationship**; **Service component command**. See FM 100-7.

fuze – (NATO) A device which initiates an explosive train. See FM 5-250.

—G—

GA – The symbol for the nerve agent tabun. (FM 3-9)

gap – (DOD) An area within a minefield or obstacle belt, free of live mines or obstacles, whose width and direction will allow a friendly force to pass through in tactical formation. See FM 3-90. (NATO) In land mine warfare, an area within a barrier, free of obstacles and not exposed to the effects of mines, whose width and direction allow a friendly force to pass through in tactical formation. (Army/Marine Corps) 1. Any break or breach in the continuity of tactical dispositions or formations beyond effective small arms coverage. Gaps (soft spots, weaknesses) may in fact be physical gaps in the enemy's disposition, but they also may be any weakness in time, space, or capability; a moment in time when the enemy is overexposed and vulnerable, a seam in an air defense umbrella, an infantry unit caught unprepared in open terrain, or a boundary between two units. (FM 20-32) 2. A ravine, mountain pass, or river that presents an obstacle that must be bridged. (FM 20-32) See also **lane**; **phoney minefield**.

gap marker – (DOD, NATO) In landmine warfare, markers used to indicate a minefield gap. Gap markers at the entrance to and exit from the gap will be referenced to a landmark or intermediate marker. See FM 20-32.

GB – The symbol for the nerve agent sarin. (FM 3-9)

GD – The symbol for the nerve agent soman. (FM 3-9)

general military intelligence – (DOD) Intelligence concerning the (1) military capabilities of foreign countries or organizations or (2) topics affecting potential US or multinational military operations, relating to the following subjects: armed forces capabilities, including order of battle, organization, training, tactics, doctrine, strategy, and other factors bearing on

military strength and effectiveness; area and terrain intelligence, including urban areas, coasts and landing beaches, and meteorological, oceanographic, and geological intelligence; transportation in all modes; military materiel production and support industries; military and civilian command, control, communications, computers, and intelligence systems; military economics, including foreign military assistance; insurgency and terrorism; military-political-sociological intelligence; location, identification, and description of military-related installations; government control; escape and evasion; and threats and forecasts. (Excludes scientific and technical intelligence.) Also called **GMI**. See also **intelligence**. See FM 34-1.

general support – (DOD, NATO) That support which is given to the supported force as a whole and not to any particular subdivision thereof. [Note: the Army designates general support as a “support relationship.”] Also called **GS**. See also **direct support**; **general support-reinforcing**; **mutual support**; **support**. See FM 101-5.

general support artillery – (DOD, NATO) Artillery which executes the fire directed by the commander of the unit to which it organically belongs or is attached. It fires in support of the operation as a whole rather than in support of a specific subordinate unit. [Note: the Army considers this a tactical artillery mission.] Also called **GSA**. See also **direct support artillery**; **general support-reinforcing**; **reinforcing**. See FM 6-20.

general support-reinforcing – (DOD) General support-reinforcing artillery has the mission of supporting the force as a whole and of providing reinforcing forces for other artillery units. Also called **GSR**. See also **direct support artillery**; **reinforcing**. See FM 101-5.

general war – (DOD) Armed conflict between major powers in which the total resources of the belligerents are employed, and the national survival of a major belligerent is in jeopardy. See also **conflict**; **military operations other than war**; **stability operations**; **support operations**. See FM 27-10.

georef – (DOD, NATO) A worldwide position reference system that may be applied to any map or chart graduated in latitude and longitude regardless of projection. It is a method of expressing latitude and longitude in a form suitable for rapid reporting and plotting. (This term is derived from the words “The World Geographic Reference System”). See FM 3-34.331.

geospatial information – Foundation information upon which all other battlespace information is referenced to form the common operational picture. (FM 3-34.230)

geospatial information and services – (DOD) The concept for collection, information extraction, storage, dissemination, and exploitation of geodetic, geomagnetic, imagery (both commercial and national source), gravimetric, aeronautical, topographic, hydrographic, littoral, cultural, and toponymic data accurately referenced to a precise location on the earth’s surface. These data are used for military planning, training, and operations, including navigation, mission planning, mission rehearsal, modeling, simulation and precise targeting. Geospatial information provides the basic framework for battlespace visualization. It is information produced by multiple sources to common interoperable data standards. It may be presented in the form of printed maps, charts, and publications; in digital simulation and modeling databases; in photographic form; or in the form of digitized maps and charts or attributed centerline data. Geospatial services include tools that enable users to access and manipulate data, and also includes instruction, training, laboratory support, and guidance for the use of geospatial data. Also called **GI&S**. See FM 3-34.230.

global positioning system – (DOD) A satellite constellation that provides highly accurate position, velocity, and time navigation information to users. Also called **GPS**. See also **way point**. See FM 3-25.26.

grappling hook – A multipurpose tool that is used for manual obstacle reduction. Soldiers use it to detonate mines from a standoff position by activating trip wires and anti-handling devices. There are two types of grappling hooks: hand-thrown and weapons-launched. (FM 3-34.2)

graves registration program – (DOD) A program that provides for search, recovery, tentative identification, and evacuation or temporary interment. Temporary interment is only authorized by the geographic combatant commander. Disposition of personal effects is included in this program. See FM 10-64.

graze – (NATO) In artillery and naval fire support, a spotting, or an observation, by a spotter or an observer to indicate that all bursts occurred on impact. [Note: the Army definition also applies to mortar fire.] See FM 6-30.

grazing fire – (DOD, NATO) Fire approximately parallel to the ground where the center of the cone of fire does not rise above one meter from the ground. See also **fire**. See FM 3-22.68.

Greenwich Mean Time – See **Universal Time**.

grey propaganda – (DOD) Propaganda that does not specifically identify any source. See also **propaganda**. See FM 33-1-1.

grid azimuth – An angle of direction referenced to grid north. It differs from true azimuth by the amount of the grid convergence. See also **azimuth**; **grid convergence**; **true azimuth**. (FM 3-25.26)

grid convergence – (DOD) The horizontal angle at a place between true north and grid north. It is proportional to the longitude difference between the place and the central meridian. See also **grid azimuth**; **magnetic azimuth**. See FM 3-25.26.

grid coordinates – (DOD, NATO) Coordinates of a grid coordinate system to which numbers and letters are assigned for use in designating a point on a gridded map, photograph, or chart. (Army) The easting and northing values (of a grid) that designate the location of a point in respect to the grid. Coordinates usually are expressed to the nearest 100, 10, or 1 meter, with the easting and northing values combined into a single expression. Examples: NK 329378 (nearest 100 meters); NK 32943785 (nearest 10 meters); or NK 3294837853 (nearest 1 meter). (FM 3-25.26)

grid north – (DOD, NATO) The northerly or zero direction indicated by the grid datum of directional reference. See FM 3-25.26.

ground combat element – (Marine Corps) The core element of a Marine air-ground task force (MAGTF) that is task-organized to conduct ground operations. It is usually constructed around an infantry organization but can vary in size from a small ground unit of any type to one or more Marine divisions that can be independently maneuvered under the direction of the MAGTF commander. It includes appropriate ground combat and combat support forces, and in a joint or multinational environment, it may contain other Service or multinational forces assigned or attached to the MAGTF. The ground combat element itself is not a formal command. Also called **GCE**. See also **aviation combat element**; **combat service support**

element; command element; Marine air-ground task force; Marine expeditionary force; Marine expeditionary force (forward); Marine expeditionary unit; special purpose Marine air-ground task force; task force.

ground tactical plan – An airborne or air assault operational plan covering the conduct of operations in the objective area. See also **landing plan; marshalling plan.** (FM 7-30)

groundwater – A body of water, generally within the boundaries of a watershed, that exists in the internal passageways of porous geological formations (aquifers) and which flows in response to gravitational forces. See also **surface water.** (FM 3-100.4)

ground zero – (DOD, NATO) The point on the surface of the Earth at, or vertically below or above, the center of a planned or actual nuclear detonation. Also called **GZ.** See also **desired ground zero.** See FM 100-30.

group – (DOD) 1. A flexible administrative and tactical unit composed of either two or more battalions or two or more squadrons. The term also applies to combat support and combat service support units. 2. A number of ships and/or aircraft, normally a subdivision of a force, assigned for a specific purpose. Also called **GP.** See FM 3-04.111. (See page 5-33 for symbol.)

group of targets – (DOD, NATO) Two or more targets on which fire is desired simultaneously. A group of targets is designated by a letter/number combination or a nickname. See also **fire plan.** See FM 6-30. (See page 7-40 for symbol.)

groups – A procedure word meaning, “This message contains the number of groups indicated.” See also **procedure word.** (FM 24-19)

g-series nerve agents – A series of fluorine- or cyanide-containing organophosphate nerve agents (organophosphate derivatives of phosphoric acid). In their unmodified state they are colorless, volatile liquids. See also **GA; GB; GD.** (FM 3-9)

guard – (DOD, NATO) 1. A form of security operation [Note: the NATO definition replaces “security operation” with “security element”] whose primary task is to protect the main force by fighting to gain time while also observing and reporting information [Note: the NATO definition ends here] and to prevent enemy ground observation of and direct fire against the main body by reconnoitering, attacking, defending, and delaying. A guard force normally operates within the range of the main body’s indirect fire weapons. See FM 3-90. 2. (DOD only) A radio frequency that is normally used for emergency transmissions and is continuously monitored. UHF band: 243.0 MHZ; VHF band: 121.5 MHZ. See FM 11-32. 3. A military or civilian individual assigned to protect personnel, equipment, or installations, or to oversee a prisoner. See FM 3-19.1. See also **cover; flank guard; screen.** (See page A-6 for symbol.)

guerrilla warfare – (DOD, NATO) Military and paramilitary operations conducted in enemy-held or hostile territory by irregular, predominantly indigenous forces. See also **unconventional warfare.** See FM 100-25.

gun-target line – (DOD, NATO) An imaginary straight line from gun to target. Also called **GTL.** See also **observer-target line.** See FM 6-30.

—H—

H – The symbol for LeVinson mustard, a blister agent. (FM 3-9)

hachuring – (NATO) A method of representing relief upon a map or chart by shading in short disconnected lines drawn in the direction of the slopes. See FM 3-25.26.

handover line – (DOD, NATO) A control feature, preferably following easily defined terrain features, at which responsibility for the conduct of combat operations is passed from one force to another. See also **battle handover line**. See FM 3-90. (See page 7-15 for symbol.)

hang fire – (DOD, NATO) A malfunction that causes an undesired delay in the functioning of a firing system. [Note: the NATO definition does not include “A malfunction that causes”]. (Army) Temporary failure or delay in the action of a primer, an igniter, or a propelling charge. (FM 6-50)

harassing fire – (DOD, NATO) Fire designated to disturb the rest of the enemy troops, to curtail movement, and, by threat of losses, to lower morale. See also **fire support**. See FM 6-20-40.

hasty attack – (DOD, NATO) In land operations, an attack in which preparation time is traded for speed in order to exploit an opportunity. See also **assault; attack; deliberate attack; movement to contact**. See FM 3-90.

hasty crossing – (DOD, NATO) The crossing of an inland water obstacle using the crossing means at hand or those readily available, and made without pausing for elaborate preparations. See also **bridgehead; deliberate crossing**. See FM 90-13.

hasty defense – (DOD, NATO) A defense normally organized while in contact with the enemy or when contact is imminent and time available for the organization is limited. It is characterized by improvement of the natural defensive strength of the terrain by utilization of foxholes, emplacements, and obstacles. See also **deliberate defense; emplacement; obstacle**. See FM 3-90.

hasty operation – An operation in which a commander directs his immediately available forces, using fragmentary orders to perform activities with minimal preparation, trading planning and preparation time for speed of execution. (FM 3-90)

hasty smoke – Smoke operations characterized by minimal planning and short duration to immediately counter enemy action. (FM 3-50)

hazard – (DOD) A condition with the potential to cause injury, illness, or death of personnel; damage to or loss of equipment or property; or mission degradation. See also **injury; risk**. See FM 100-14.

hazard communication – The responsibility of leaders and supervisors concerning possible hazards in the workplace and notification of hazards and necessary precaution to their soldiers. Also called **HAZCOM**. (FM 3-100.4)

hazardous material – Any substance which has a human health hazard associated with it. Special storage, use, handling, and shipment safety procedures and protocols must be followed to help protect against accidental exposure. Hazardous materials are specifically identified under federal law. (FM 3-100.4)

hazardous substances – Materials specifically listed under federal regulations for which the spilling of certain quantities requires immediate reporting to federal agencies. (FM 3-100.4)

hazardous waste – A solid waste which is either listed as such in federal law or exhibits any of the four hazardous characteristics—ignitability, corrosivity, reactivity, or toxicity. See also **corrosivity; ignitability; reactivity; solid waste; toxicity; waste**. (FM 3-100.4)

hazardous waste accumulation site – A specially designated site for the temporary collection of hazardous wastes where no container may remain on site for more than 90 days. The site, and containers within it, must be properly marked and certain safety and management procedures apply. There is no limitation on the quantity of wastes which may be kept on site. (FM 3-100.4)

haze (smoke) – A light concentration of smoke placed over friendly areas to restrict accurate enemy observation and fire. A smoke haze is not dense enough to disrupt friendly operations. (FM 3-50)

HD – The symbol for distilled LeVinson mustard, a blister agent. (FM 3-9)

health service support – (DOD) All services performed, provided, or arranged by the Services, to promote, improve, conserve, or restore the mental or physical well-being of personnel. [Note: the Army definition adds here “... in the Army and, as directed, for other Services, agencies, and organizations.” It does not include what follows in the DOD definition.] These services include but are not limited to the management of health services resources, such as manpower, monies, and facilities; preventive and curative health measures; evacuation of the wounded, injured, or sick; selection of the medically fit and disposition of the medically unfit; blood management; medical supply, equipment, and maintenance thereof; combat stress control; and medical, dental, veterinary, laboratory, optometric, medical food, and medical intelligence services. Also called **HSS**. See FM 4-0.

health threat – (DOD) A composite of ongoing or potential enemy actions; environmental, occupational, and geographic and meteorological conditions; endemic diseases; and employment of nuclear, biological, and chemical weapons (to include weapons of mass destruction) that can reduce the effectiveness of joint forces through wounds, injuries, illness, and psychological stressors. (Army) Refers to an individual soldier’s health. The term can include hereditary conditions that manifest themselves in adulthood, individual exposure to an industrial chemical or toxin where others are not exposed, or other injuries and traumas that affect an individual’s health rather than the health of the unit. (FM 4-02.17)

heavy drop – (DOD) A system of delivery of heavy supplies and equipment by parachute. Also called **HD**. See FM 10-1.

height of burst – (DOD, NATO) The vertical distance from the Earth’s surface or target to the point of burst. Also called **HOB**. See also **desired ground zero; ground zero**. See FM 100-30.

helicopter approach route – (NATO) The track or series of tracks along which helicopters move to a specific landing site or landing zone. See FM 1-112.

herringbone – An arrangement of vehicles at left and right angles to the line of march used to establish security during an unscheduled halt. (FM 3-20.15)

H-hour – (DOD) 1. The specific hour on D-day at which a particular operation commences. 2. For amphibious operations, the time the first assault elements are scheduled to touch down on the beach, or a landing zone, and in some cases the commencement of countermining breaching operations. See also **times**. See FM 101-5.

hide – The positioning of a vehicle, individual, or unit so that no part is exposed to observation or direct fire. See also **concealment; cover; defilade**. (FM 3-20.15)

high-altitude missile engagement zone – (DOD) In air defense, that airspace of defined dimensions within which the responsibility for engagement of air threats normally rests with high-altitude surface-to-air missiles. Also called **HIMEZ**. See also **weapon engagement zone**. See FM 3-52. (See page 7-21 for symbol.)

high angle fire – (DOD, NATO) Fire delivered at angles of elevation greater than the elevation that corresponds to the maximum range of the gun and ammunition concerned; fire, the range of which decreases as the angle of elevation is increased. (Army) Fire delivered to clear an obstacle (such as a hill) that low-angle fire cannot, or fire delivered to attack targets on the reverse side of an obstacle (such as a hill) that cannot be attacked with low-angle or direct fire. (FM 6-30).

high-density airspace control zone – (DOD) Airspace designated in an airspace control plan or airspace control order, in which there is a concentrated employment of numerous and varied weapons and airspace users. A high-density airspace control zone has defined dimensions, which usually coincide with geographical features or navigational aids. Access to a high-density airspace control zone is normally controlled by the maneuver commander. The maneuver commander can also direct a more restrictive weapons status within the high-density airspace control zone. Also called **HIDACZ**. See also **airspace coordination area; restricted operating area/zone**. See FM 3-52. (See page 7-20 for symbol.)

high-payoff target – (DOD) A target whose loss to the enemy will significantly contribute to the success of the friendly course of action. High-payoff targets are those high-value targets that must be acquired and successfully attacked for the success of the friendly commander's mission. Also called **HPT**. See also **high value target; target**. See FM 6-20-10.

high-value target – (DOD) A target the enemy commander requires for the successful completion of the mission. The loss of high-value targets would be expected to seriously degrade important enemy functions throughout the friendly commander's area of interest. Also called **HVT**. See also **high priority target; target**. See FM 60-20-10.

highway regulation – Planning, routing, scheduling, and deconflicting the use of main supply routes and other routes to provide order, prevent congestion, enforce priorities, and facilitate movement control. See also **alternate supply route; main supply route**. (FM 4-01.30)

HL – The symbol for a blister agent consisting of a mustard-lewisite mixture. (FM 3-9)

HN – The symbol for nitrogen mustard, a blister agent. (FM 3-9)

hold – (DOD, NATO) 1. A cargo stowage compartment aboard ship. 2. To maintain or retain possession by force, as a position or an area. [Note: the NATO definition reads "In land operations, to maintain possession of a position or area by force."] See FM 3-90. 3. In an attack, to exert sufficient pressure to prevent movement or redistribution of enemy forces. See FM 3-90. 4. As applied to air traffic, to keep an aircraft within a specified space or location which is identified by visual or other means in accordance with Air Traffic Control instructions. See FM 3-04.111. See also **fix; retain**.

hold fire – (NATO) In air defense, an emergency order to stop firing. Missiles already in flight must be prevented from intercepting, if technically possible. See also **cease engagement**. See FM 44-100.

holding area – 1. A site located between assembly areas or forward arming and refueling points and battle positions that may be occupied for short periods of time by attack helicopters while coordination is being made for movement into the battle positions. It should provide good cover and concealment and an area for the aircraft to hover or land. (FM 3-04.111)
2. Nearest covered and concealed position to the pickup zone or river crossing site where troops are held until time for them to move forward. (FM 7-30) 3. Waiting area that forces use during traffic interruptions or deployment from an aerial or sea port of embarkation. (FM 3-19.4)

holding line – In retrograde river crossing operations, the outer limit of the area established between the enemy and the water obstacle to preclude direct and observed indirect fires into the crossings. (FM 90-13) (See page 7-34 for symbol.)

hostage – (DOD) A person held as a pledge that certain terms or agreements will be kept. (The taking of hostages is forbidden under the Geneva Conventions, 1949). See FM 27-10.

hostile – (DOD) In combat and combat support operations, an identity applied to a track declared to belong to any opposing nation, party, group, or entity, which by virtue of its behavior or information collected on it such as characteristics, origin, or nationality contributes to the threat to friendly forces. See FM 1-02. (Army) An individual, group of individuals, or nation which is antagonistic or opposes policies and actions of the United States and its allies. The action of a hostile can be political, diplomatic, or at any level of war. See also **neutral**; **suspect**; **unknown**. (FM 27-10) (See page 4-3 for symbols.)

hostile act – (DOD) 1. A hostile act is an attack or other use of force by any civilian, paramilitary, or military force or terrorist(s) (with or without national designation) against the United States, US forces and, in certain circumstances, US nationals and their property, US commercial assets, or other designated non-US forces, foreign nationals, and their property. 2. Force used directly to preclude or impede the mission and/or duties of US forces, including the recovery of US personnel and vital US Government property. When a hostile act is in progress the right exists to use proportional force, including armed force, in self-defense by all necessary means available to deter or neutralize the potential attacker or, if necessary, to destroy the threat. See FM 27-10.

hostile criteria – Description of conditions under which an aircraft or a vehicle may be identified as hostile for engagement purposes. See also **hostile acts**; **rules of engagement**. (FM 3-04.111)

hostile environment – (DOD) Operational environment in which hostile forces have control as well as the intent and capability to effectively oppose or react to the operations a unit intends to conduct. See also **operational environment**. See FM 3-07.

host nation – (DOD) A nation that receives the forces and/or supplies of allied nations, coalition partners, and/or NATO organizations to be located on, to operate in, or to transit through its territory. Also called **HN**. See also **civil-military operations**; **host country**. See FM 3-07.

host-nation support – (DOD) Civil and/or military assistance rendered by a nation to foreign forces within its territory during peacetime, crises or emergencies, or war based on agreements mutually concluded between nations. See also **civil-military operations**. See FM 3-07.

H-series agents – A series of persistent blister agents that include distilled mustard (HD) and the nitrogen mustards. See also **H**; **HD**; **HL**; **HN**; **HT**. (FM 3-9)

HT – The symbol for a mustard-T mixture, a blister agent. (FM 3-9)

hull down – The positioning of an armored vehicle so that the muzzle of the gun or launcher is the lowest part of the vehicle exposed to the front. Hull down positions afford maximum protection for vehicles that are engaging targets with direct fire. (FM 3-20.15)

human intelligence – (DOD, NATO) A category of intelligence derived from information collected and provided by human sources. [Note: in Army and Marine Corps usage, human intelligence operations cover a wide range of activities encompassing reconnaissance patrols, aircrew reports and debriefs, debriefing of refugees, interrogations of prisoners of war, and the conduct of counterintelligence force protection source operations.] Also called **HUMINT**. See FM 34-1.

human intelligence collector – A person who is trained to collect information from individuals (human intelligence sources) for the purpose of answering intelligence information requirements. Also called **HUMINT collector**. (FM 34-52)

human intelligence source – A person from whom information is collected for the purpose of producing intelligence. Human intelligence sources can include friendly, neutral, or hostile personnel. Also called **HUMINT source**. (FM 34-52)

humanitarian and civic assistance – (DOD) Assistance to the local populace provided by predominantly US forces in conjunction with military operations and exercises. This assistance is specifically authorized by Title 10, United States Code, section 401, and funded under separate authorities. Assistance provided under these provisions is limited to (1) medical, dental, and veterinary care provided in rural areas of a country; (2) construction of rudimentary surface transportation systems; (3) well drilling and construction of basic sanitation facilities; and (4) rudimentary construction and repair of public facilities. Assistance must fulfill unit training requirements that incidentally create humanitarian benefit to the local populace. Also called **HCA**. See also **foreign humanitarian assistance**. See FM 3-07.

humanitarian assistance coordination center – (DOD) A temporary center established by a geographic combatant commander to assist with interagency coordination and planning. A humanitarian assistance coordination center operates during the early planning and coordination stages of foreign humanitarian assistance operations by providing the link between the geographic combatant commander and other United States Government agencies, nongovernmental organizations, and international and regional organizations at the strategic level. Also called **HACC**. See also **foreign humanitarian assistance; interagency coordination**. See FM 41-10.

human resource support – A combat service support function: all activities and functions to sustain personnel manning of the force and provide personnel service support to service members, their families, Department of the Army civilians, and contractors. These activities include personnel accounting; casualty management; next-of-kin notification; essential services; postal operations; and morale, welfare, and recreation. (FM 4-0)

hybrid collective protection – A combination of overpressure and ventilated face-piece systems. (FM 3-11.4)

hydrolysis – Interaction of a chemical agent with water to yield a less toxic product or products. (FM 3-6)



I authenticate – A procedure word meaning, “The group that follows is the reply to your challenge to authenticate.” See also **procedure word**. (FM 24-19)

identification, friend or foe – (DOD) A device that emits a signal positively identifying it as a friendly. (NATO) A system using electromagnetic transmissions to which equipment carried by friendly forces automatically responds, for example, by emitting pulses, thereby distinguishing themselves from enemy forces. Also called **IFF**. See also **air defense**. See FM 44-100.

identification, friend or foe on/off line – A theater-directed phase line where aircraft involved in operations forward of the fire support coordination line turn off the aircraft identification friend or foe transponder en route to the target and turn on the transponder after completing the mission. Also called **IFF on/off line**. See also **identification friend or foe; phase line**. (FM 44-100)

ignitability – One of the four possible characteristics of hazardous waste as defined by the Environmental Protection Agency. It is the ability to catch fire. See also **hazardous waste**. (FM 3-100.4)

imagery intelligence – (DOD) Intelligence derived from the exploitation of collection by visual photography, infrared sensors, lasers, electro-optics, and radar sensors such as synthetic aperture radar wherein images of objects are reproduced optically or electronically on film, electronic display devices, or other media. Also called **IMINT**. See also **intelligence**. See FM 34-1.

imitative electromagnetic deception – (DOD) The introduction of electromagnetic energy into enemy systems that imitates enemy emissions. (Army) Imitating enemy electromagnetic radiation (predominantly communications) through his electromagnetic channels to deceive him or to disrupt his operations. Also called **IED**. See also **deception; electromagnetic deception; electronic warfare; manipulative electromagnetic deception; simulative electromagnetic deception**. (FM 3-13)

immediate – A procedure word meaning, “Precedence immediate.” The precedence reserved for messages relating to situations which gravely affect the security of national/allied forces or populace, and which require immediate delivery. See also **procedure word**. (FM 24-19)

immediate air support – (DOD, NATO) Air support to meet specific requests which arise during the course of a battle and which by their nature cannot be planned in advance. See also **air support**. See FM 6-30.

immediate decontamination – (DOD) Decontamination carried out by individuals immediately upon becoming contaminated. It is performed in an effort to minimize casualties, save lives, and limit the spread of contamination. [Note: See APP-6.] Also called **emergency decontamination**. See also **decontamination**. See FM 3-5.

immediate mission request – (DOD) A request for an air strike on a target that, by its nature, could not be identified sufficiently in advance to permit detailed mission coordination and planning. [Note: the NATO term is “request for immediate air support.”] See FM 6-20.

immediate permanent ineffectiveness – The physiological response to radiation at levels of 3,000 centigrays (cGy) for physically demanding tasks or 3,800 cGy for physically

undemanding tasks. Personnel become ineffective within three minutes of exposure and remain ineffective until death. Death occurs within one day. (FM 3-3-1)

immediate target(s) – (DOD) Targets that have been identified too late, or not selected for action in time to be included in the normal targeting process, and therefore have not been scheduled. Immediate targets have two subcategories: unplanned and unanticipated. See also **planned target(s)**; **target**; **unanticipated immediate target**; **unplanned immediate target**. See FM 6-20-40.

immediate transient ineffectiveness – The physiological response to radiation at levels of 2,000 centigrays (cGy) for physically demanding tasks or 2,800 cGy for physically undemanding tasks. Personnel become ineffective for any task within 3 minutes of exposure and remain so for approximately 7 minutes. Personnel recover to greater than 75 percent of their pre-exposure performance levels after about 10 minutes and remain so for about 30 minutes. Then their performance degrades for around 5 hours for undemanding tasks or 2 hours for demanding tasks, when radiation sickness becomes so severe that they are ineffective. They remain ineffective until death, which usually occurs in 5 to 6 days. (FM 3-3-1)

impact point – See **point of impact**.

implied task – A task that must be performed to accomplish the mission, but is not stated in the higher headquarters order. See also **essential task**; **specified task**. (FM 101-5)

incapacitating agent – (DOD) An agent that produces temporary physiological or mental effects, or both, which will render individuals incapable of concerted effort in the performance of their assigned duties. See FM 3-9.

incendiary – A compound that generates sufficient heat to cause the target to catch fire or causes melting or burning of equipment. (FM 3-9)

indications and warning – (DOD) Those intelligence activities intended to detect and report time-sensitive intelligence information on foreign developments that could involve a threat to the United States or allied and/or coalition military, political, or economic interests or to US citizens abroad. It includes forewarning of enemy actions or intentions; the imminence of hostilities; insurgency; nuclear or non-nuclear attack on the United States, its overseas forces, or allied and/or coalition nations; hostile reactions to US reconnaissance activities; terrorist attacks; and other similar events. Also called **I&W**. See also **information**; **intelligence**. See FM 34-1.

indicator – (DOD, NATO) In intelligence usage, an item of information which reflects the intention or capability of a potential enemy to adopt or reject a course of action. See FM 34-1.

indirect approach – To attack the enemy center of gravity by applying combat power against a series of decisive points that avoid enemy strengths. (FM 3-0)

indirect fire – (DOD) Fire delivered on a target that is not itself used as a point of aim for the weapon or the director. See also **direct laying**. See FM 6-30.

indirect illumination – (NATO) Battlefield illumination provided by employing searchlight or pyrotechnic illuminants using diffusion or reflection. a. **Illumination by diffusion**: illumination of an area beneath and to the flanks of a slightly elevated searchlight or of pyrotechnic illuminants, by the light scattered from atmospheric particles. b. **Illumination**

by reflection: illumination of an area by reflecting light from low cloud. Either or both of these effects are present when a searchlight is used in defilade or with its beam spread to maximum width. See FM 6-20.

individual protection – (DOD) Actions taken by individuals to survive and continue the mission under nuclear, biological, and chemical conditions. See also **protection**. See FM 3-11.4.

induced environment – (DOD) Any manmade or equipment-made environment that directly or indirectly affects the performance of man or materiel. See FM 3-100.4.

induced radiation – (DOD, NATO) Radiation produced as a result of exposure to radioactive materials, particularly the capture of neutrons. See also **contamination; residual radioactivity**. See FM 3-3-1.

in extremis – (DOD) A situation of such exceptional urgency that immediate action must be taken to minimize imminent loss of life or catastrophic degradation of the political or military situation. See FM 100-25.

infiltration – (DOD) 1. The movement through or into an area or territory occupied by either friendly or enemy troops or organizations. The movement is made, either by small groups or by individuals, at extended or irregular intervals. When used in connection with the enemy, it infers that contact is avoided. See FM 3-0. 2. In intelligence usage, placing an agent or other person in a target area in hostile territory. Usually involves crossing a frontier or other guarded line. Methods of infiltration are: black (clandestine); grey (through legal crossing point but under false documentation); and white (legal). See FM 34-1. (Army) 1. A form of maneuver in which an attacking force conducts undetected movement through or into an area occupied by enemy forces to occupy a position of advantage in the enemy rear while exposing only small elements to enemy defensive fires. (FM 3-90) 2. In a tactical vehicular march, dispatching of vehicles in small groups, or at irregular intervals, at a rate that keeps the traffic density down and prevents undue massing of vehicles. (FM 3-90) See also **exfiltration; forms of maneuver**.

infiltration lane – A control measure that coordinates forward and lateral movement of infiltrating units and fixes fire planning responsibilities. (FM 3-90) (See page 7-30 for symbol.)

inflight report – (DOD) The transmission from the airborne system of information obtained both at the target and en route. See FM 3-04.111.

influence – To cause adversaries or others to behave in a manner favorable to Army forces. (FM 3-13)

info – A procedure word meaning, “The addressees immediately following are addressed for information.” See also **procedure word**. (FM 24-19)

informant – 1. A person who, wittingly or unwittingly, provides information to an agent, a clandestine service, or the police. 2. In reporting, a person who has provided specific information and is cited as a source. See also **human intelligence; military operations other than war; stability operations; support operations**. (FM 34-1)

information – (DOD) 1. Facts, data, or instructions in any medium or form. 2. The meaning that a human assigns to data by means of known conventions used in their representation.

(NATO) Unprocessed data of every description which may be used in the production of intelligence. (Army) 1. In the general sense, the meaning humans assign to data. 2. In the context of the cognitive hierarchy, data that have been processed to provide further meaning. (FM 6-0)

information assurance – (DOD) Information operations that protect and defend information and information systems by ensuring their availability, integrity, authentication, confidentiality, and nonrepudiation. This includes providing for restoration of information systems by incorporating protection, detection, and reaction capabilities. Also called **IA**. See also **information**; **information operations**; **information system**. See FM 3-13.

information environment – (DOD) The aggregate of individuals, organizations or systems that collect, process, or disseminate information; also included is the information itself. See also **information system**. See FM 3-13.

information fratricide – The results of employing information operations elements in a way that causes effects in the information environment that impede the conduct of friendly operations or cause adverse effects on friendly forces. (FM 3-13)

information management – The provision of relevant information to the right person at the right time in a usable form to facilitate situational understanding and decisionmaking. It uses procedures and information systems to collect, process, store, display, and disseminate information. (FM 3-0)

information operations – (DOD) Actions taken to affect adversary information and information systems while defending one's own information and information systems. (Army) The employment of the core capabilities of electronic warfare, computer network operations, psychological operations, military deception, and operations security, in concert with specified supporting and related capabilities, to affect and defend information and information systems and to influence decisionmaking. Also called **IO**. See also **defensive information operations**; **information**; **information system**; **offensive information operations**. (FM 3-13)

information operations vulnerabilities – Deficiencies in protective measures that may allow an adversary to use information operations capabilities against friendly information systems or command and control systems. Also called **IO vulnerabilities**. (FM 3-13)

information requirements – (DOD, NATO) Those items of information regarding the enemy and his environment which need to be collected and processed in order to meet the intelligence requirements of a commander. (Army) All information elements the commander and staff require to successfully conduct operations, that is, all elements necessary to address the factors of METT-TC. [Note: the Marine Corps uses METT-T]. Also called **IR**. See also **commander's critical information requirements**; **priority intelligence requirements**. (FM 6-0)

information security – (DOD) The protection and defense of information and information systems against unauthorized access or modification of information, whether in storage, processing, or transit, and against the denial of service to authorized users. Information security includes those measures necessary to detect, document, and counter such threats. Information security is composed of computer security and communications security. Also called **INFOSEC**. See also **communications security**; **computer security**; **information system**. See FM 3-13.

information superiority – (DOD) That degree of dominance in the information domain which permits the conduct of operations without effective opposition. (Army) The operational advantage derived from the ability to collect, process, and disseminate an uninterrupted flow of information while exploiting or denying an adversary's ability to do the same. Also called **IS**. See also **information operations**; **information system**. (FM 3-0)

information system – (DOD) The entire infrastructure, organization, personnel, and components that collect, process, store, transmit, display, disseminate, and act on information. (Army) The equipment and facilities that collect, process, store, display, and disseminate information. This includes computers—hardware and software—and communications, as well as policies and procedures for their use. Also called **INFOSYS**. See also **information**. (FM 3-0)

initial nuclear effects – Effects that occur within the first minute, including initial nuclear radiation, blast, and thermal and electromagnetic pulse. (FM 3-3-1)

initial point – (DOD) 1. The first point at which a moving target is located on a plotting board. See FM 6-20. 2. A well-defined point, easily distinguishable visually and/or electronically, used as a starting point for the bomb run to the target. See FM 6-30. 3. airborne—A point close to the landing area where serials (troop carrier air formations) make final alterations in course to pass over individual drop or landing zones. See FM 90-26. 4. helicopter—An air control point in the vicinity of the landing zone from which individual flights of helicopters are directed to their prescribed landing sites. See FM 3-04.111. 5. Any designated place at which a column or element thereof is formed by the successive arrival of its various subdivisions, and comes under the control of the commander ordering the move. Also called **IP**.

initial response force – (DOD) The first unit, usually military police, on the scene of a terrorist incident. (Army) Units designated by the commander to respond to emergency situations, usually military police, firefighters, and medical personnel. See also **antiterrorism**. (FM 3-19.1)

initiative (individual) – The ability to be a self-starter, to act when there are no clear instructions or when the situation changes. (FM 22-100)

initiative (operational) – Setting or dictating the terms of action throughout the battle or operation. (FM 3-0)

injury – (DOD) A term comprising such conditions as fractures, wounds, sprains, strains, dislocations, concussions, and compressions. In addition, it includes conditions resulting from extremes of temperature or prolonged exposure. Acute poisonings (except those due to contaminated food) resulting from exposure to toxic or poisonous substances are also classed as injuries. See also **casualty**. See FM 4-02.

insertion – 1. Placement of troops and equipment into an operational area in air assault operations. 2. Placement of observation posts, patrols, or raiding parties by helicopter, parachute, watercraft, or other means. Stealth is normally desired in the execution of an insertion. See also **air assault operation**. (FM 90-4)

in support of – (DOD) Assisting or protecting another formation, unit, or organization while remaining under original control. (NATO) Term designating the support provided to another unit, formation, or organization while remaining under the initial command. See also **support**. See FM 101-5.

insurgency – (DOD, NATO) An organized movement aimed at the overthrow of a constituted government through the use of subversion and armed conflict. See also **counterinsurgency**. See FM 3-07.

integrated warfare – (DOD) The conduct of military operations in any combat environment wherein opposing forces employ non-conventional weapons in combination with conventional weapons. See FM 3-11.

intelligence – (DOD) 1. The product resulting from the collection, processing, integration, analysis, evaluation, and interpretation of available information concerning foreign countries or areas. 2. Information and knowledge about an adversary obtained through observation, investigation, analysis, or understanding. See FM 34-1. (Marine Corps) In Marine Corps usage, intelligence is knowledge about the enemy or the surrounding environment needed to support decisionmaking. This knowledge is the result of the collection, processing, exploitation, evaluation, integration, analysis, and interpretation of available information about the battlespace and threat. See also **all-source intelligence**; **combat intelligence**; **communications intelligence**; **electronic intelligence**; **general military intelligence**; **imagery intelligence**; **measurement and signature intelligence**; **medical intelligence**; **scientific and technical intelligence**; **technical intelligence**.

intelligence battlefield operating system – (Army) The activity to generate knowledge of and products portraying the enemy and the environmental features required by a command planning, preparing, executing, and assessing operations. See **battlefield operating system**. (FM 7-15)

intelligence cycle – The process by which information is converted into intelligence and made available to users. [Note: the joint community as a whole, and the US Army and US Marine Corps as individual Services use intelligence cycles whose steps differ somewhat from one another in emphasis on utilization of intelligence. See JP 1-02, FM 34-1, and MCWP 2-15.4 respectively for specific joint, Army, and Marine Corps usages.]

intelligence discipline – (DOD) A well-defined area of intelligence collection, processing, exploitation, and reporting using a specific category of technical or human resources. There are seven major disciplines: human intelligence, imagery intelligence, measurement and signature intelligence, signals intelligence (communications intelligence, electronic intelligence, and foreign instrumentation signals intelligence), open source intelligence, technical intelligence, and counterintelligence. See also **counterintelligence**; **human intelligence**; **imagery intelligence**; **intelligence**; **measurement and signature intelligence**; **signals intelligence**; **technical intelligence**. [Note: the Army definition replaces “all-source analysis and production” with “open source intelligence.”] See FM 34-1.

intelligence handover line – The boundary between areas of intelligence responsibility. The intelligence handover line (IHL) may be defined either dynamically (for example, the division IHL will be 3 km in front of its committed brigade’s forward line of own troops) or conceptually (for example, to coincide with a phase line). Also called **IHL**. (FM 34-130)

intelligence preparation of the battlefield – The systematic, continuous process of analyzing the threat and environment in a specific geographic area. Intelligence preparation of the battlefield (IPB) is designed to support the staff estimate and military decisionmaking process. Most intelligence requirements are generated as a result of the IPB process and its interrelation with the decisionmaking process. Also called **IPB**. (FM 34-130)

intelligence preparation of the battlespace – (DOD) An analytical methodology employed to reduce uncertainties concerning the enemy, environment, and terrain for all types of operations. Intelligence preparation of the battlespace builds an extensive database for each potential area in which a unit may be required to operate. The database is then analyzed in detail to determine the impact of the enemy, environment, and terrain on operations and presents it in graphic form. Intelligence preparation of the battlespace is a continuing process. See FM 34-130. (Marine Corps) In Marine Corps usage, the systematic, continuous process of analyzing the threat and the environment in a specific geographic area. Also called **IPB**.

intelligence quick reaction capabilities – The rapid development and allocation of a temporary means (based on an operational requirement) to overcome detection, collection, and processing gaps that are validated in an intelligence survey. These means include developing or modifying existing components of a current system or developing a new stand-alone system to supplement baseline intelligence capabilities. (FM 34-1)

intelligence reach – A process by which deployed military forces rapidly access information, receive support, and conduct collaboration and information sharing with other units (deployed in theater and from outside the theater) unconstrained by geographic proximity, echelon, or command. (FM 34-1)

intelligence support element – A tactically tailored intelligence support team, uniquely configured commander's intelligence staff with assured communications, automated intelligence processing, and communications networks needed to support the commander's decisionmaking. The intelligence support element (ISE) is not a permanent organization, specific unit, or specific quantity of equipment. If the ISE is the forward element of the analysis and control element, it is normally the foundation on which a full analysis and control element is formed, after the lodgment is secured and subsequent operations begin. Also called **ISE**. (FM 34-1)

intelligence, surveillance, and reconnaissance – An enabling operation that integrates and synchronizes all battlefield operating systems to collect and produce relevant information to facilitate the commander's decisionmaking. Also called **ISR**.

intelligence, surveillance, and reconnaissance assets – Those organizations, systems, sensors, personnel, and equipment dedicated to or directed toward the collection of information in response to the commander's critical intelligence requirements. Also called **ISR assets**.

intelligence, surveillance, and reconnaissance plan – An integrated plan for collection of information from all available sources that is driven by the commander's critical information requirements. The plan tasks ISR assets to collect critical information within a required timeline. The plan is revised and updated as the commander's information requirements change. Also called **ISR plan**. See also **commander's critical information requirements; intelligence cycle**.

intelligence survey – An integrated program, coordinated across all disciplines but executed within each discipline, to systematically task, collect, process, analyze and produce, and disseminate intelligence on a specific threat in order to evaluate and overcome gaps in current baseline intelligence capabilities. The intelligence survey validates and further defines the nature and extent of the gap. This survey results in validating existing databases or changes to the databases, and identifying new threat capabilities. (FM 34-1)

intelligence synchronization matrix – A graphic representation that ties the collection plan to an operation and the commander’s intelligence needs. (FM 101-5).

interagency coordination – (DOD) Within the context of the Department of Defense involvement, the coordination that occurs between elements of the Department of Defense and engaged US Government agencies, nongovernmental organizations, and regional and international organizations for the purpose of accomplishing the objective. See also **nongovernmental organizations**. See FM 3-0.

interception – The art of searching for and listening to and/or recording communications and/or electronic transmissions for the purpose of obtaining intelligence. (FM 34-1)

interdict – A tactical mission task where the commander prevents, disrupts, or delays the enemy’s use of an area or route. (FM 3-90) (See page A-4 for symbol.)

interdiction – (DOD) An action to divert, disrupt, delay, or destroy the enemy’s surface military potential before it can be used effectively against friendly forces. See also **air interdiction**. See FM 3-0.

interdiction fire – (NATO) Fire placed on an area or point to prevent the enemy from using the area or point. See also **fire**; **interdict**; **interdiction**. See FM 6-20-40.

interior lines – A force operates on interior lines when its operations diverge from a central point. (FM 3-0)

intermediate staging base – (DOD) A temporary location used to stage forces prior to inserting the forces into the host nation. (Army) A secure staging base established near to, but not in, the area of operations. Also called **ISB**. See also **base**; **staging base**. (FM 3-0)

internal defense and development – (DOD) The full range of measures taken by a nation to promote its growth and to protect itself from subversion, lawlessness, and insurgency. It focuses on building viable institutions (political, economic, social, and military) that respond to the needs of society. Also called **IDAD**. See also **foreign internal defense**. See FM 3-07.

internal security – (DOD) The state of law and order prevailing within a nation. See also **foreign internal defense**; **internal defense and development**. See FM 3-07.

interned – (DOD) A casualty who is definitely known to have been taken into custody of a nonbelligerent foreign power as the result of and for reasons arising out of any armed conflict in which the Armed Forces of the United States are engaged. See FM 4-02. (Army) Anyone taken and kept as a prisoner of war. (FM 3-19.40) See also **missing**.

internment and resettlement – A military police mission that involves enemy prisoners of war/civilian internee handling, US military prisoner handling, and populace and resource control. Internment and resettlement operations address military police and criminal investigation division (CID) roles in control of populations (enemy prisoners of war/civilian internees, US military prisoners, and dislocated civilians). This function involves those measures necessary to provide shelter, sustain, guard, protect, and account for populations. (FM 3-19.1)

interoperability – (DOD, NATO) 1. The ability of systems, units, or forces to provide services to and accept services from other systems, units, or forces and to use the services so exchanged to enable them to operate effectively together. See FM 3-0. 2. (DOD only) The condition

achieved among communications-electronics systems or items of communications-electronics equipment when information or services can be exchanged directly and satisfactorily between them and/or their users. The degree of interoperability should be defined when referring to specific cases.

interrogation – (DOD) Systematic effort to procure information by direct questioning of a person under the control of the questioner. (Army) The systematic effort to procure information to answer specific collection requirements by direct and indirect questioning techniques of a person who is in the custody of the forces conducting the questioning. (FM 34-52)

intervisibility – The condition of being able to see one point from another. This condition may be altered or interrupted by weather, smoke, terrain masking dust, or debris. See also **concealment; cover**. (FM 34-130)

intervisibility line – A ridge or horizon beyond which equipment or personnel can be hidden from observation. (FM 34-130)

in-transit visibility – (DOD) The ability to track the identity, status, and location of Department of Defense units and non-unit cargo (excluding bulk petroleum, oils, and lubricants) and passengers; medical patients; and personal property from origin to consignee or destination across the range of military operations. Also called **ITV**. See also **total asset visibility**. See FM 10-1.

in-transit visibility collection point – A point where an in-transit visibility (ITV) device is placed for the purpose of recording ITV information on units, unit equipment, or sustainment cargo. (FM 10-1)

intratheater airlift – (DOD) Airlift conducted within a theater. Assets assigned to a geographic combatant commander or attached to a subordinate joint force commander normally conduct intratheater airlift operations. Intratheater airlift provides air movement and delivery of personnel and equipment directly into objective areas through airlanding, airdrop, extraction, or other delivery techniques as well as the air logistic support of all theater forces, including those engaged in combat operations, to meet specific theater objectives and requirements. During large-scale operations, US Transportation Command assets may be tasked to augment intratheater airlift operations, and may be temporarily attached to a joint force commander. Formerly referred to as theater airlift. See FM 100-17.

intrusion – (DOD) Movement of a unit or force within another nation's specified operational area outside of territorial seas and territorial airspace for surveillance or intelligence gathering in time of peace or tension. (Army) The intentional insertion of electromagnetic energy into transmission paths in any manner, with the objective of deceiving operators or of causing confusion. See also **electronic warfare; jamming; meaconing**. (FM 34-1)

intuitive decisionmaking – (Army/Marine Corps) The act of reaching a conclusion which emphasizes pattern recognition based on knowledge, judgment, experience, education, intelligence, boldness, perception, and character. This approach focuses on assessment of the situation vice comparison of multiple options. See FM 6-0

inversion – An increase of air temperature with increase in altitude (the ground being colder than the surrounding air). When an inversion exists, there are no convection currents and wind speeds are below 5 knots. The atmosphere is stable and normally is considered the most

favorable state for ground release of chemical agents. See also **haze**; **lapse**; **neutral**. (FM 3-6)

I read back – A procedure word meaning, “The following is my response to your instructions to read back.” See also **procedure word**. (FM 24-19)

irregular forces – (DOD) Armed individuals or groups who are not members of the regular armed forces, police, or other internal security forces. See FM 3-07.

irregular outer edge – (DOD, NATO) In land mine warfare, short mine rows or strips laid in an irregular manner in front of a minefield facing the enemy to deceive the enemy as to the type or extent of the minefield. Generally, the irregular outer edge will only be used in minefields with buried mines. See FM 20-32.

I say again – A procedure word meaning, “I am repeating transmission or portion indicated.” See also **procedure word**. (FM 24-19)

isolate – A tactical mission task that requires a unit to seal off—both physically and psychologically—an enemy from his sources of support, deny an enemy freedom of movement, and prevent an enemy unit from having contact with other enemy forces. See also **encirclement**. (FM 3-90) (See page A-4 for symbol.)

I spell – A procedure word meaning, “I shall spell the next word phonetically.” See also **procedure word**. (FM 24-19)

I verify – A procedure word meaning, “That which follows has been verified at your request and is repeated.” (to be used as a reply to “verify”). See also **procedure word**. (FM 24-19)

—J—

jamming – The deliberate radiation or reflection of electromagnetic energy to prevent or degrade the receipt of information by a receiver. It includes communications and noncommunications jamming. See also **barrage jamming**; **electromagnetic interference**; **electronic attack**; **electronic warfare**; **imitative electronic deception**; **intrusion**; **meaconing**. (FM 34-1)

joint air attack team – A combination of US Army attack and scout aircraft and fixed-wing close air support aircraft operating together to locate and attack high priority targets, such as tanks and other targets of opportunity. The joint air attack team normally operates in a coordinated effort with fire support, air defense artillery, and ground maneuver forces against enemy armored formations, command vehicles, and enemy air defense weapon systems. Also called **JAAT**. (FM 1-112)

joint civil-military operations task force – (DOD) A joint task force composed of civil-military operations units from more than one Service. It provides support to the joint force commander in humanitarian or nation assistance operations, theater campaigns, or civil-military operations concurrent with or subsequent to regional conflict. It can organize military interaction among many governmental and nongovernmental humanitarian agencies within the theater. Also called **JCMOTF**. See FM 41-10.

joint engagement zone – (DOD) In air defense, that airspace of defined dimension within which multiple air defense systems (surface-to-air missiles and aircraft) are simultaneously employed to engage air threats. Also called **JEZ**. See also **weapon engagement zone**. See FM 3-52.

joint force – (DOD) A general term applied to a force composed of significant elements, assigned or attached, of two or more Military Departments, operating under a single joint force commander. See also **joint force commander**. See FM 3-0.

joint force air component commander – (DOD) The commander within a unified command, subordinate unified command, or joint task force responsible to the establishing commander for making recommendations on the proper employment of assigned, attached, and/or made available for employment air forces; planning and coordinating air operations; or accomplishing such operational missions as may be assigned. The joint force air component commander is given the authority necessary to accomplish missions and tasks assigned by the establishing commander. Also called **JFACC**. See also **joint force commander**. See FM 100-7.

joint force commander – (DOD) A general term applied to a combatant commander, subunified commander, or joint task force commander authorized to exercise combatant command (command authority) or operational control over a joint force. Also called **JFC**. See also **joint force**. See FM 3-0.

joint force land component commander – (DOD) The commander within a unified command, subordinate unified command, or joint task force responsible to the establishing commander for making recommendations on the proper employment of assigned, attached, and/or made available for tasking land forces, planning and coordinating land operations, or accomplishing such operational missions as may be assigned. The joint force land component commander is given the authority necessary to accomplish missions and tasks assigned by the establishing commander. Also called **JFLCC**. See also **joint force commander**. See FM 3-0.

joint force maritime component commander – (DOD) The commander within a unified command, subordinate unified command, or joint task force responsible to the establishing commander for making recommendations on the proper employment of assigned, attached, and/or made available for tasking maritime forces and assets; planning and coordinating maritime operations, or accomplishing such operational missions as may be assigned. The joint force maritime component commander is given the authority necessary to accomplish missions and tasks assigned by the establishing commander. Also called **JFMCC**. See also **joint force commander**. See FM 100-7.

joint force special operations component commander – (DOD) The commander within a unified command, subordinate unified command, or joint task force responsible to the establishing commander for making recommendations on the proper employment of assigned, attached, and/or made available for tasking special operations forces and assets; planning and coordinating special operations; or accomplishing such operational missions as may be assigned. The joint force special operations component commander is given the authority necessary to accomplish missions and tasks assigned by the establishing commander. Also called **JFSOCC**. See also **joint force commander**. See FM 100-25.

Joint Operation Planning and Execution System – (DOD) A system that provides the foundation for conventional command and control by national- and combatant command-level commanders and their staffs. It is designed to satisfy their information needs in the conduct of joint planning and operations. Joint Operation Planning and Execution System (JOPES) includes joint operation planning, policies, procedures, and reporting structures supported by communications and automated data processing systems. JOPES is used to monitor, plan, and execute mobilization, deployment, employment, and sustainment

activities associated with joint operations. Also called **JOPES**. See also **joint operations**. See FM 3-0.

joint operations – (DOD) A general term to describe military actions conducted by joint forces, or by Service forces in relationships (e.g., support, coordinating authority), which, of themselves, do not create joint forces. See FM 3-0.

joint operations area – (DOD) An area of land, sea, and airspace defined by a geographic combatant commander or subordinate unified commander in which a joint force commander (normally a joint task force commander) conducts military operations to accomplish a specific mission. Joint operations areas are particularly useful when operations are limited in scope and geographic area or when operations are to be conducted on the boundaries between theaters. Also called **JOA**. See also **area of responsibility**; **joint special operations area**. See FM 3-0.

joint psychological operations task force – (DOD) A joint special operations task force composed of headquarters and operational assets. It assists the joint force commander in developing strategic, operational, and tactical psychological operations plans for a theater campaign or other operations. Mission requirements will determine its composition and assigned or attached units to support the joint task force commander. Also called **JPOTF**. See also **joint special operations task force**; **psychological operations**; **special operations**. See FM 3-05.30.

joint rear area – (DOD) A specific land area within a joint force commander's operational area designated to facilitate protection and operations of installations and forces supporting the joint force. Also called **JRA**. See also **joint force**; **joint force commander**; **rear area**. See FM 3-0.

joint special operations air component commander – (DOD) The commander within the joint force special operations command responsible for planning and executing joint special air operations and for coordinating and deconflicting such operations with conventional nonspecial operations air activities. The joint special operations air component commander normally will be the commander with the preponderance of assets and/or greatest ability to plan, coordinate, allocate, task, control, and support the assigned joint special operations aviation assets. The joint special operations air component commander may be directly subordinate to the joint force special operations component commander or to any nonspecial operations component or joint force commander as directed. Also called **JSOACC**. See FM 100-25.

joint special operations area – (DOD) A restricted area of land, sea, and airspace assigned by a joint force commander to the commander of a joint special operations force to conduct special operations activities. The commander of joint special operations forces may further assign a specific area or sector within the joint special operations area to a subordinate commander for mission execution. The scope and duration of the special operations forces' mission, friendly and hostile situation, and politico-military considerations all influence the number, composition, and sequencing of special operations forces deployed into a joint special operations area. It may be limited in size to accommodate a discrete direct action mission or may be extensive enough to allow a continuing broad range of unconventional warfare operations. Also called **JSOA**. See FM 100-25.

joint special operations task force – (DOD) A joint task force composed of special operations units from more than one Service, formed to carry out a specific special operation or

prosecute special operations in support of a theater campaign or other operations. The joint special operations task force may have conventional nonspecial operations units assigned or attached to support the conduct of specific missions. Also called **JSOTF**. See FM 100-25.

joint suppression of enemy air defenses – (DOD) A broad term that includes all suppression of enemy air defense activities provided by one component of the joint force in support of another. Also called **J-SEAD**. See also **suppression of enemy air defenses**. See FM 6-20-30.

joint task force – (DOD) A joint force that is constituted and so designated by the Secretary of Defense, a combatant commander, a subunified commander, or an existing joint task force commander. Also called **JTF**. See FM 3-0. (See page 5-38 for symbol.)

—K—

key communicator – An individual to whom the target audience turns most often for an analysis or interpretation of information or events. (FM 3-05.30)

key terrain – (DOD, NATO) Any locality, or area, the seizure or retention of which affords a marked advantage to either combatant. See also **decisive terrain; intelligence preparation of the battlefield**. See FM 3-90.

killed in action – (DOD) A casualty category applicable to a hostile casualty, other than the victim of a terrorist activity, who is killed outright or who dies as a result of wounds or other injuries before reaching a medical treatment facility. Also called **KIA**. See also **casualty; died of wounds; graves registration program; hostile casualty; nonhostile casualty**. See FM 8-55.

kill zone – That part of an ambush site where fire is concentrated to isolate, fix, and destroy the enemy. (FM 3-90)

knowledge – In the context of the cognitive hierarchy, information analyzed to provide meaning and value or evaluated as to implications for the operation. (FM 6-0)

—L—

landing area – (DOD) 1. The part of the operational area within which are conducted the landing operations of an amphibious force. It includes the beach, the approaches to the beach, the transport areas, the fire support areas, the airspace occupied by close supporting aircraft, and the land included in the advance inland to the initial objective. 2. (Airborne) The general area used for landing troops and materiel either by airdrop or air landing. This area includes one or more drop zones or landing strips. See FM 90-26. 3. Any specially prepared or selected surface of land, water, or deck designated or used for takeoff and landing of aircraft. See FM 3-04.111. See also **airhead; amphibious force; drop zone; landing beach; landing zone; objective**.

landing beach – (DOD, NATO) That portion of a shoreline usually required for the landing of a battalion landing team. However, it may also be that portion of a shoreline constituting a tactical locality (such as the shore of a bay) over which a force larger or smaller than a battalion landing team may be landed. See also **amphibious operation**.

landing force – (DOD) A Marine Corps or Army task organization formed to conduct amphibious operations. The landing force, together with the amphibious task force,

constitutes the amphibious force. See also **amphibious force**; **amphibious operation**; **amphibious task force**.

landing mat – (DOD, NATO) A prefabricated portable mat so designed that any number of planks (sections) may be rapidly fastened together to form surfacing for emergency runways, landing beaches, etc. See FM 5-430-00-2.

landing plan – (DOD) 1. In amphibious operations, a collective term referring to all individually prepared naval and landing force documents that, taken together, present in detail all instructions for execution of the ship-to-shore movement. 2. In airlift operations, the sequence, method of delivery, and place of arrival of troops and materiel. See FM 90-4.

landing point – (DOD, NATO) A point within a landing site where one helicopter or vertical takeoff and landing aircraft can land. See also **air assault operation**; **landing site**; **landing zone**. See FM 90-4.

landing site – (DOD, NATO) 1. A site within a landing zone containing one or more landing points. See FM 90-4. 2. In amphibious operations, a continuous segment of coastline over which troops, equipment, and supplies can be landed by surface means.

landing zone – (DOD, NATO) Any specified zone used for the landing of aircraft. Also called **LZ**. See also **air assault operation**; **airhead**. See FM 90-4. (See page 7-17 for symbol.)

landing zone control party – (DOD, NATO) Personnel specially trained and equipped to establish and operate communications devices from the ground for traffic control of aircraft/helicopters for a specific landing zone. See also **air assault operation**. See FM 90-4.

lane – (Army) A route through an enemy or friendly obstacle that provides a passing force safe passage. The route may be reduced and proofed as part of a breach operation, or constructed as part of a friendly obstacle. It is a clear route that moves all the way through an obstacle. (FM 3-34.2) (Marine Corps) A clear route through an obstacle. A lane for foot troops is a minimum of one meter in width and may be further expanded. A foot lane is marked with tracing tape along its center line. A single lane for vehicles is a minimum of eight meters in width; a double lane is at least 15 meters in width. Vehicle lanes are marked by any means available. See also **gap**. (See page 7-54 for symbol.)

lane marker – (DOD, NATO) In land mine warfare, sign used to mark a minefield lane. Lane markers, at the entrance to and exit from the lane, may be referenced to a landmark or intermediate marker. See also **breach**; **gap**; **lane**. See FM 20-32.

lapse – A marked decrease in air temperature with increasing altitude because the ground is warmer than the surrounding air. This condition usually occurs between 1100 and 1600 hours, local time, when the skies are clear. Strong convection currents exist during lapse conditions. For chemical operations, the state is defined as unstable and is normally considered the most unfavorable for the release of chemical agents. See also **inversion**; **neutral**. (FM 3-6)

large-scale map – (DOD) A map having a scale of 1:75,000 or larger. See also **map**. See FM 3-25.26.

lashing – See **tie down**.

latent (nuclear) ineffectiveness – 1. The minimum exposure that will result in the average service member becoming performance-degraded within three hours and remaining so until death. 2. The minimum exposure that will result in the average service member becoming combat ineffective at any time within six weeks of postexposure. (FM 100-30)

lateral boundary – Control measure that defines the left or right limit of a unit's operational area. Together with the rear and forward boundaries and a coordinating altitude, lateral boundaries define the area of operations for a commander. (FM 3-90) (See page 7-12 for symbol.)

lateral spread – (DOD) A technique used to place the mean point of impact of two or more units 100 meters apart on a line perpendicular to the gun-target line. See FM 6-20-40.

lateral tell – See **cross tell**.

latest time information is of value – The time by which an intelligence organization or staff must deliver information to the requester in order to provide decisionmakers with timely intelligence. This must include the time anticipated for processing and disseminating that information, as well as for making the decision. (FM 34-1)

latest time intelligence is of value – (Marine Corps) The time by which information must be delivered to the requestor in order to provide decisionmakers with timely intelligence. Also called **LTIOV**.

law and order – A military police mission consisting of those measures necessary to enforce laws, directives, and punitive regulations. Tasks include law enforcement, criminal investigation, and support to US Customs operations. On the battlefield, law and order operations are conducted only when the combat commander requires it and when battle intensity permits. (FM 3-19.1)

law of armed conflict – See **law of war**.

law of war – (DOD) That part of international law that regulates the conduct of armed hostilities. Also called **the law of armed conflict**; **LOW**. See also **rules of engagement**. See FM 27-10.

lay – (DOD) 1. Direct or adjust the aim of a weapon. See FM 6-20. 2. Setting of a weapon for a given range, a given direction, or both. See FM 6-20. 3. To drop one or more aerial bombs or aerial mines onto the surface from an aircraft. See 3-04.111. 4. To spread a smoke screen on the ground from an aircraft. See FM 3-04.111. 5. To calculate or project a course. See FM 3-04.111. 6. To lay on: a. to execute a bomber strike; b. to set up a mission. See FM 3-04.111.

leadership – Influencing people by providing purpose, direction, and motivation while operating to accomplish the mission and improving the organization. (FM 22-100)

least separation distance – The minimum distance that a desired ground zero must be separated from an object to ensure no more than a 10 percent chance of damage with a 99 percent assurance. It is the sum of the radius of preclusion and the buffer distance. Also called **LSD**. See also **desired ground zero**; **minimum safe distance**. (FM 100-30)

level of care – Describes the five levels of treatment within the military health care system. Each level has the same capabilities as the level before it, but adds a new treatment capability that distinguishes it from the previous level. **Level I**: The first medical care a

soldier receives is provided at this level. This care includes immediate lifesaving measures, emergency medical treatment, advanced trauma management (ATM), disease prevention, stress prevention, casualty collection, and evacuation from supported unit to supporting medical treatment facility (MTF). Level I elements are found in divisions, corps, and in echelons above corps (EAC) units. These elements include the trauma specialist assisted by first aid (self-aid/buddy aid) and enhanced first aid (combat lifesaver) and the Level I MTF (battalion aid station). Some or all of these elements are found in maneuver, combat support, and combat service support units. When a Level I medical capability is not present in a unit, this support is provided, on an area support basis, to that unit by the supporting Level II medical unit. **Level II:** Capabilities duplicate Level I and expand available services by adding operational dental care, laboratory, x-ray, and patient holding capabilities. Some Level II facilities also have mental health and preventive medicine capabilities. Emergency medical treatment and ATM is continued. If necessary, additional emergency measures are instituted; however, these measures do not exceed those dictated by the immediate needs. Level II units are located in the combat zone (brigade, division, corps support areas) and at EAC. Forward support, brigade support, main support, division support, area support medical companies, and medical troops provide Level II medical care. The forward surgical team (FST) from the corps collocates with a medical company/troop and provides emergency resuscitative surgical capability. The combined medical company and FST are generally considered to be Level II+. This capability is organic to the medical company/troop, main support battalion, division support command, airborne and air assault divisions, and the support squadron, armor cavalry regiment (light). **Level III:** This level of support expands the support provided at Level II. Level III characterizes the care that is provided by the combat support hospital (CSH) in the corps. Minimum operational functions required for a Level III hospital include: command, control, and communications; patient administration; nutritional care; supply and services; triage; emergency medical treatment; pre-operative care; orthopedics; general surgery; operating rooms and central materiel and supply services; anesthesia, nursing services (to include intensive and intermediate care wards); pharmacy; clinical laboratory and blood banking; radiology services; and hospital ministry team services. Operational conditions may require Level III units to locate in offshore support facilities, third country support bases, or in other locations. Level III hospitalization provides hospital care to all classes of patients and with medical resupply can indefinitely sustain care. The Level III hospital in some environments may be augmented with specialty teams, such as head and neck or renal hemodialysis team. **Level IV:** This level of care is provided at an EAC CSH that is normally augmented with additional and specialized medical and surgical capabilities and with additional patient holding capabilities. The EAC CSH is staffed and equipped for general and specialized medical and surgical treatment. This level of care provides further treatment to stabilize those patients requiring evacuation to continental United States (CONUS). **Level V (CONUS Support Base):** This definitive level of care is provided in the CONUS support base. The patient is treated in hospitals staffed and equipped to provide the most definitive care available. Hospitals used to provide this care are not limited to US Army hospitals. Hospitals from the other Military Services, the Department of Veterans Affairs, and the civilian health care systems may also be included. Civilian hospitals include those hospitals that are members of the National Disaster Medical Systems. (FM 4-02)

levels of risk – Utilizing the risk assessment matrix, the point where the severity row and probability column intersect defines the level of risk. There are four levels of risk: extremely high risk (E), high risk (H), moderate risk (M), and low risk (L). See also **risk assessment matrix**. (FM 100-14)

lewisite – A blister agent (an arsenical vesicant) used as a moderately delayed-action casualty agent with a persistency somewhat shorter than HD (distilled mustard). It produces effects similar to mustard, although unlike mustard, it produces immediate pain. (FM 3-9)

L-hour – (DOD) 1. The specific hour on C-day at which a deployment operation commences or is to commence. 2. In amphibious operations, the time at which the first helicopter of the helicopter-borne assault wave touches down in the landing zone. See also **times**. See FM 101-5.

liaison – (DOD, NATO) That contact or intercommunication maintained between elements of military forces or other agencies [Note: the NATO definition does not include “or other agencies”] to ensure mutual understanding and unity of purpose and action. See FM 6-0.

lift – All helicopters assigned to a particular mission to move troops, supplies, and equipment. See also **air assault operation**; **chalk**. (FM 3-04.111)

lift fire – In direct fire, the command to raise the cone of fire so that the beaten zone strikes the target, but the space between the target and the firing weapons is safe for maneuver by friendly forces. (FM 7-8)

light line – (DOD, NATO) A designated line forward of which vehicles are required to use black-out lights at night. Also called **LL**. See FM 3-90. (See page 7-44 for symbol.)

limited access route – A one-way route with one or more restrictions which preclude its use by the full range of military traffic. See also **alternate supply route**; **main supply route**. (FM 4-01.30).

limited visibility operations – Operations conducted at night and during other periods of reduced visibility. See also **final coordination line**; **limit of advance**; **probable line of deployment**. (FM 3-90)

limit of advance – (Army) A phase line used to control forward progress of the attack. The attacking unit does not advance any of its elements or assets beyond the limit of advance, but the attacking unit can push its security forces to that limit. (FM 3-90) (Marine Corps) An easily recognized terrain feature beyond which attacking elements will not advance. Also called **LOA**. See also **final coordination line**; **probable line of deployment**. (See page 7-31 for symbol.)

limit of fire – (DOD, NATO) 1. The boundary marking off the area on which gunfire can be delivered. 2. Safe angular limits for firing at aerial targets. (Army) Tactical markers used to define the sector of fire for an individual soldier, a weapon system, or a unit that prevents fratricide of adjacent units and focuses fire to kill the enemy. See also **engagement area**; **final protective line**. (FM 3-20.15)

line – (NATO) In artillery and naval gunfire support, a spotting, or an observation used by a spotter or an observer to indicate that a burst(s) occurred on the spotting line. [Note: the Army definition also applies to mortar fire.] See FM 6-30.

line formation – An arrangement of vehicles or personnel in which elements are arranged abreast of each other. This formation permits maximum fire to front and rear and a minimum of fire to the flanks. See also **box formation**; **column formation**; **echelon formation**; **formation**; **vee formation**; **wedge formation**. (FM 3-90)

- line haul** – In highway transportation, a type of haul involving long trips over the road in which the portion of driving time is high in relation to the time consumed in loading and unloading. Line haul usually involves one trip or a portion of a trip per operating shift of 10 hours, or 2 trips per day. (FM 4-01.30)
- line of communications** – (DOD) A route, either land, water, and/or air, that connects an operating military force with a base of operations and along which supplies and military forces move. Also called **LOC**. See also **communications zone**; **route**. See FM 3-0.
- line of contact** – A general trace delineating the locations where friendly and enemy forces are engaged. [Note: the Marine Corps definition replaces “friendly and enemy forces” with “two opposing forces.”] Also called **LC**. See also **forward edge of the battle area**; **forward line of own troops**; **line of departure**; **line of departure is line of contact**. (FM 3-90) (See page 7-14 for symbol.)
- line of demarcation** – (DOD) A line defining the boundary of a buffer zone or an area of limitation. A line of demarcation may also be used to define the forward limits of disputing or belligerent forces after each phase of disengagement or withdrawal has been completed. See also **area of limitation**; **buffer zone**; **disengagement**; **peace operations**. See FM 3-07.
- line of departure** – (DOD, NATO) 1. In land warfare, a line designated to coordinate the departure of attack elements. 2. In amphibious warfare, a suitably marked offshore coordinating line to assist assault craft to land on designated beaches at scheduled times. (Army) A phase line crossed at a prescribed time by troops initiating an offensive operation. Also called **LD**. See also **line of contact**; **line of departure is line of contact**. (FM 3-90) (See page 7-31 for symbol.)
- line of departure is line of contact** – The designation of forward friendly positions as the line of departure when opposing forces are in contact. Also called **LD/LC**. See also **line of contact**; **line of departure**. (FM 3-90) (See page 7-31 for symbol.)
- line of sight** – The unobstructed path from a soldier, weapon, weapon sight, electronic-sending and -receiving antennas, or piece of reconnaissance equipment to another point. Also called **LOS**. See also **intervisibility**. (FM 34-130)
- lines of operations** – (DOD) Lines that define the directional orientation of the force in time and space in relation to the enemy. They connect the force with its base of operations and its objectives. See FM 3-0.
- linkup** – (Army) A meeting of friendly ground forces which occurs in a variety of circumstances. (FM 3-90) (Marine Corps) An operation wherein two friendly ground forces join together in a hostile area. See also **linkup point**.
- linkup point** – A point where two infiltrating elements in the same or different infiltration lanes are scheduled to meet to consolidate before proceeding with their missions. See also **air assault operation**; **airborne operation**; **breakout**; **linkup**. (FM 3-90) (See page 7-42 for symbol.)
- list of targets** – (DOD) A tabulation of confirmed or suspect targets maintained by any echelon for informational and fire support planning purposes. See also **fire plan**; **target list**. See FM 6-20-10.

loading plan – (DOD, NATO) All of the individually prepared documents which, taken together, present in detail all instructions for the arrangement of personnel, and the loading of equipment for one or more units or other special groupings of personnel or material moving by highway, water, rail, or air transportation. See FM 55-1.

local air defense warning – Air attack probabilities that allow the local commander to alert his forces to air and/or missile attack without changing the air defense warning conditions. Local air defense warnings (LADW) are designed to alert a particular unit, several units, or an area of the battlefield. LADW parallel air defense warning conditions and reflect the local air and missile threat. a. **Dynamite**—Aircraft are inbound or attacking now. Response is immediate. b. **Lookout**—Aircraft are in the area of interest but are not threatening or are inbound but there is time to react. c. **Snowman**—No aircraft pose a threat at this time. Also called **LADW**. (FM 44-100)

local air superiority – Air superiority maintained for a specific time and space in support of a particular operation. (FM 3-04.111)

local haul – In highway transportation, a type of haul characterized by short driving time in relation to loading and unloading time and normally involving four or more trips per day. (FM 4-01.30)

local security – (Army) Low-level security operations conducted near a unit to prevent surprise by the enemy. (FM 3-90) (Marine Corps) Those security elements established in the proximity of a unit to prevent surprise by the enemy.

lock on – (DOD) Signifies that a tracking or target-seeking system is continuously and automatically tracking a target in one or more coordinates (e.g., range, bearing, elevation). (NATO) The state of a tracking system or target acquisition system which is continuously and automatically tracking a target using one or more parameters. See FM 44-100.

lodgment area – (DOD) 1. A designated area in a hostile or threatened territory which, when seized and held, ensures the continuous air landing of troops and materiel and provides the maneuver space necessary for projected operations. Normally it is the area seized in the assault phase of an airborne operation. See FM 90-26. 2. A designated location in an area of operations used as a base for supply and evacuation by air. See FM 90-26. 3. A designated area on a hostile or potentially hostile site that, when seized and held, ensures the continuous landing of troops and materiel and provides maneuver space requisite for subsequent projected operations ashore. See also **airhead**; **beachhead**.

log crib – A type of point obstacle used as a road block that cannot be readily bypassed. See also **abatis**; **cratering charge**; **point obstacle**; **road block**. (FM 5-34)

log hurdle – A type of point obstacle used to slow tracked vehicles and make them more vulnerable to antitank fires or make the tracked vehicles vulnerable to “belly shots” as they climb over the hurdles. See also **abatis**; **cratering charge**; **point obstacle**; **road block**. (FM 5-34)

logistics – (DOD) The science of planning and carrying out the movement and maintenance of forces. In its most comprehensive sense, those aspects of military operations which deal with: a. design and development, acquisition, storage, movement, distribution, maintenance, evacuation, and disposition of materiel; b. movement, evacuation, and hospitalization of personnel; c. acquisition or construction, maintenance, operation, and disposition of facilities; and d. acquisition and furnishing of services. (NATO) The science of planning and carrying

out the movement and maintenance of forces. In its most comprehensive sense, those aspects of military operations which deal with: a. design and development, acquisition, storage, transport, distribution, maintenance, evacuation, and disposition of materiel; b. transport of personnel; c. acquisition, construction, maintenance, operation, and disposition of facilities; d. acquisition or furnishing of services; and e. medical and health support services. See also **combat service support**. See FM 4-0.

logistics assault base – A temporary logistics support area transported across enemy lines via helicopter to support extended deep air assault and raids. If the logistics assault base is to become a permanent facility, the unit must develop it into a forward operations base. Also called **LAB**. (FM 90-4)

logistics base – A principal or supplementary base of support; a locality containing installations which provide logistics support. (FM 4-0)

logistics-over-the-shore operations – (DOD) The loading and unloading of ships without the benefit of deep draft-capable, fixed port facilities, in friendly or nondefended territory, and, in time of war, during phases of theater development in which there is no opposition by the enemy; or as a means of moving forces close to tactical assembly areas dependent on threat force capabilities. Also called **LOTS operations**. See FM 4-0.

logistics package – A grouping of multiple classes of supplies and supply vehicles under the control of a single convoy commander. Also called **LOGPAC**. (FM 4-0)

logistics preparation of the theater – Actions taken by combat service support personnel to optimize means—force structure, resources, and strategic lift—of supporting the joint force commander's plan. (FM 4-0)

logistics release point – 1. The point along the supply route where the unit first sergeant or unit guide takes control of a company logistics package. 2. The point along the supply route where the supported unit meets the supporting unit to transfer supplies. Also called **LRP**. (FM 4-0) (See page 7-63 for symbol.)

log posts – A type of point obstacle with posts placed in belts and combined with wire and usually used as a road block or turning obstacle. To breach a belt of log posts requires an extensive breaching effort. See also **abatis**; **cratering charge**; **point obstacle**; **road block**. (FM 5-34)

lost – (NATO) In artillery and naval gunfire support, a spotting or an observation used by a spotter or an observer to indicate that rounds fired by a gun or mortar were not observed. [Note: the Army definition also applies to direct fire gunnery.] See FM 6-30.

low-altitude missile engagement zone – (DOD) In air defense, that airspace of defined dimensions within which the responsibility for engagement of air threats rests with low- to medium-altitude surface-to-air missiles. Also called **LOMEZ**. See also **weapon engagement zone**. See FM 3-52. (See page 7-21 for symbol.)

low-level transit route – (DOD, NATO) A temporary corridor of defined dimensions established in the forward area to minimize the risk to friendly aircraft from friendly air defenses or surface forces. Also called **LLTR**. See also **air corridor**; **flight corridor**; **minimum-risk route**. See FM 3-52. (See page 7-20 for symbol.)

—M—

magnetic azimuth – An angle of direction measured clockwise from magnetic north. See also **azimuth**; **grid azimuth**; **true azimuth**. (FM 3-25.26)

magnetic declination – (DOD, NATO) The angle between the magnetic and geographical meridians at any place, expressed in degrees east or west to indicate the direction of magnetic north from true north. In nautical and aeronautical navigation, the term magnetic variation is used instead of magnetic declination and the angle is termed variation of the compass or magnetic variation. Magnetic declination is not otherwise synonymous with magnetic variation, which refers to regular or irregular change with time of the magnetic declination, dip, or intensity. See also **magnetic variation**. See FM 3-25.26.

magnetic mine – (DOD, NATO) A mine which responds to the magnetic field of a target. See FM 20-32.

magnetic variation – (DOD, NATO) 1. In navigation, at a given place and time, the horizontal angle between the true north and magnetic north measured east or west according to whether magnetic north lies east or west of true north. 2. In cartography, the annual change in direction of the horizontal component of the Earth's magnetic field. See also **magnetic declination**. See FM 3-25.26.

main battle area – (DOD) That portion of the battlefield in which the decisive battle is fought to defeat the enemy. For any particular command, the main battle area extends rearward from the forward edge of the battle area to the rear boundary of the command's subordinate units. (Army) The area where the commander intends to deploy the bulk of his combat power and conduct his decisive operations to defeat an attacking enemy. Also called **MBA**. See also **defensive operations**; **forward edge of the battle area**; **handover line**. (FM 3-90)

main body – The principal part of a tactical command or formation. It does not include detached elements of the command, such as advance guards, flank guards, and covering forces. (FM 3-90)

main command post – A cell that includes those staff activities involved in controlling and sustaining current operations and in planning future operations. (See page 5-39 for symbol.)

main detonating line – (DOD, NATO) In demolition, a line of detonating cord used to transmit the detonation wave to two or more branches. See FM 5-250.

main effort – (Army) The activity, unit, or area that commanders determine constitutes the most important task at that time. (FM 3-0) (Marine Corps) The designated subordinate unit whose mission at a given point in time is most critical to overall mission success. It is usually weighted with the preponderance of combat power and is directed against a center of gravity through a critical vulnerability.

main operations base – (DOD) In special operations, a base established by a joint force special operations component commander or a subordinate special operations component commander in friendly territory to provide sustained command and control, administration, and logistical support to special operations activities in designated areas. Also called **MOB**. See also **advanced operations base**; **forward operations base**. See FM 100-25.

main supply route – (DOD, NATO) The route or routes designated within an operational area upon which the bulk of traffic flows in support of military operations. Also called **MSR**. See FM 4-01.30. (See page 7-69 for symbol.)

maintenance (materiel) – (DOD) 1. All action taken to retain materiel in serviceable condition or to restore it to serviceability. It includes inspection, testing, servicing, classification as to serviceability, repair, rebuilding, and reclamation. 2. All supply and repair action taken to keep a force in condition to carry out its mission. 3. The routine recurring work required to keep a facility (plant, building, structure, ground facility, utility system, or other real property) in such condition that it may be continuously used, at its original or designed capacity and efficiency for its intended purpose. (Army) Actions taken to keep materiel in serviceable, operational condition, and updating and upgrading its capability. It includes performing preventive maintenance checks and services; recovering and evacuating disabled equipment; diagnosing equipment faults; substituting parts, components, and assemblies; exchanging serviceable materiel for unserviceable materiel; and repairing equipment. (FM 4-30.3) (See page 5-25 for symbols.)

maintenance collection point – A point established to collect equipment awaiting repair, controlled exchange, cannibalization, or evacuation. It may be operated by the user or by the direct support maintenance units. Also called **MCP**. See also **unit maintenance collection point**. (FM 4-30.3) (See page 7-63 for symbol.)

maintenance status – (DOD) 1. A nonoperating condition, deliberately imposed, with adequate personnel to maintain and preserve installations, materiel, and facilities in such a condition that they may readily be restored to operable condition in a minimum time by the assignment of additional personnel and without extensive repair or overhaul. 2. That condition of materiel that is in fact, or is administratively classified as, unserviceable, pending completion of required servicing or repairs. 3. A condition of materiel readiness that reports the level of operational readiness for a piece of equipment. See FM 4-30.3.

maintenance support team – A tailored direct support team that collocates with a unit maintenance element for a designated period. Also called **MST**. (FM 4-30.3)

major disaster – (DOD) Any flood, fire, hurricane, tornado, earthquake, or other catastrophe which, in the determination of the President, is or threatens to be of sufficient severity to warrant disaster assistance by the Federal Government under Public Law 606, 91st Congress (42 United States Code 58) to supplement the efforts and available resources of State and local governments in alleviating the damage and hardship, or suffering caused thereby. See also **domestic emergencies**. See FM 3-07.

major operation – (DOD) A series of tactical actions (battles, engagements, strikes) conducted by various combat forces of a single or several Services, coordinated in time and place, to accomplish operational and, sometimes, strategic objectives in an operational area. These actions are conducted simultaneously or sequentially in accordance with a common plan and are controlled by a single commander. See also **operation**. See FM 3-0.

maneuver – (DOD, NATO) 1. A movement to place ships, aircraft, or land forces in a position of advantage over the enemy. 2. A tactical exercise carried out at sea, in the air, on the ground, or on a map in imitation of war. 3. The operation of a ship, aircraft, or vehicle, to cause it to perform desired movements. 4. Employment of forces in the battlespace through movement in combination with fires to achieve a position of advantage in respect to the enemy in order to accomplish the mission. [Note: the NATO definition replaces “in the battlespace” with “on

the battlefield.”] (Army) One of the nine principles of war: Place the enemy in a disadvantageous position through the flexible application of combat power. See also **mission; operation; principles of war**. (FM 3-0)

maneuver and mobility support – A military police mission performed to support and preserve the commander’s freedom of movement in his area of responsibility and enhance the movement of friendly resources in all environments. Tasks include route reconnaissance and surveillance, main supply route regulation and enforcement, temporary route signing, support to river crossings, and straggler and refugee control. Also called **MMS**. (FM 3-19.1)

maneuver battlefield operating system – (Army) The movement of forces to achieve a position of advantage with respect to enemy forces. This system includes the employment of forces in combination with direct fire or fire potential. This system also includes the conduct of tactical tasks associated with force protection. See also **battlefield operating systems**. (FM 7-15)

manifest – (DOD) A document specifying in detail the passengers or items carried for a specific destination. See FM 55-1.

manipulative electromagnetic deception – (DOD) Actions to eliminate revealing, or convey misleading, electromagnetic telltale indicators that may be used by hostile forces. Also called **MED**. See also **electronic warfare; electromagnetic deception; imitative electromagnetic deception; simulative electromagnetic deception**. See FM 3-13.

map – (DOD, NATO) A graphic representation, usually on a plane surface, and at an established scale, of natural or artificial features on the surface of part or whole of the Earth or other planetary body. These features are positioned relative to a coordinate reference system. See also **large-scale map; medium-scale map; small-scale map**. See FM 3-25.26.

march column – A group of two to five serials using the same route for a single movement, organized under a single commander for planning, regulating, and controlling. See also **march serial; march unit; movement order**. (FM 3-90)

march serial – A subdivision of a march column consisting of a group of two to five march units using the same route for a single movement, organized under a single commander for planning, regulating, and controlling. See also **march column; march unit; movement order**. (FM 3-90)

march unit – The smallest subdivision of a march column; a group of normally no more than 25 vehicles using the same route for a single movement organized under a single commander for planning, regulating, and controlling. See also **march column; march serial; movement order**. (FM 3-90)

Marine air-ground task force – (Marine Corps) The Marine Corps principal organization for all missions across the range of military operations, composed of forces task-organized under a single commander capable of responding rapidly to a contingency anywhere in the world. The types of forces in the Marine air-ground task force (MAGTF) are functionally grouped into four core elements: a command element, an aviation combat element, a ground combat element, and a combat service support element. The four core elements are categories of forces, not formal commands. The basic structure of the MAGTF never varies, though the number, size, and type of Marine Corps units comprising each of its four elements will always be mission dependent. The flexibility of the organizational structure allows for one or more subordinate MAGTFs to be assigned or attached. In a joint or multinational

environment, other Service or multinational forces may be assigned or attached to the MAGTF. Also called **MAGTF**. See also **aviation combat element; combat service support element; command element; ground combat element; Marine expeditionary brigade; Marine expeditionary force; Marine expeditionary force (forward); Marine expeditionary unit; special purpose Marine air-ground task force; task force**.

Marine expeditionary brigade – (Marine Corps) A Marine air-ground task force that is constructed around a reinforced infantry regiment, a composite Marine aircraft group, and a brigade service support group. The Marine expeditionary brigade (MEB), commanded by a general officer, is task-organized to meet the requirements of a specific situation. It can function as part of a joint task force, as the lead echelon of the Marine expeditionary force (MEF), or alone. It varies in size and composition, and is larger than a Marine expeditionary unit but smaller than a MEF. The MEB is capable of conducting missions across the full range of military operations. In a joint or multinational environment, the MEB may contain other Service or multinational forces assigned or attached. Also called **MEB**. See also **brigade; Marine air-ground task force; Marine expeditionary force**.

Marine expeditionary force – (Marine Corps) The largest Marine air-ground task force (MAGTF) and the Marine Corps principal warfighting organization, particularly for larger crises or contingencies. It is task-organized around a permanent command element and normally consists of one or more Marine divisions, Marine aircraft wings, and Marine force service support groups. The Marine expeditionary force is capable of missions across the range of military operations, including amphibious assault and sustained operations ashore in any environment. It can operate from a sea base, a land base, or both. In a joint or multinational environment, it may also contain other Service or multinational forces assigned or attached to the MAGTF. Also called **MEF**. See also **aviation combat element; combat service support element; command element; ground combat element; Marine air-ground task force; Marine expeditionary brigade; Marine expeditionary force (forward); Marine expeditionary unit; special purpose Marine air-ground task force; task force**.

Marine expeditionary force (forward) – (DOD) A designated lead echelon of a Marine expeditionary force (MEF), task-organized to meet the requirements of a specific situation. A Marine expeditionary force (forward) varies in size and composition, and may be commanded by the MEF commander personally or by another designated commander. It may be tasked with preparing for the subsequent arrival of the rest of the MEF/joint/multinational forces, and/or the conduct of other specified tasks, at the discretion of the MEF commander. A Marine expeditionary force (forward) may also be a stand-alone Marine air-ground task force (MAGTF), task-organized for a mission in which a MEF is not required. It may also contain other Service or foreign military forces assigned or attached to the MAGTF. Also called **MEF (FWD)**. See also **aviation combat element; combat service support element; command element; ground combat element; Marine air-ground task force; Marine expeditionary force; Marine expeditionary unit; Marine expeditionary unit (special forces capable); special purpose Marine air-ground task force; task force**.

Marine expeditionary unit – (Marine Corps) A Marine air-ground task force (MAGTF) that is constructed around an infantry battalion reinforced, a helicopter squadron reinforced, and a task-organized combat service support element. It normally fulfills Marine Corps forward sea-based deployment requirements. The Marine expeditionary unit provides an immediate reaction capability for crisis response and is capable of limited combat operations. In a joint

or multinational environment, it may contain other Service or multinational forces assigned or attached to the MAGTF. Also called **MEU**. See also **aviation combat element; combat service support element; command element; ground combat element; Marine air-ground task force; Marine expeditionary force; Marine expeditionary force (forward); Marine expeditionary unit (special operations capable); special purpose Marine air-ground task force; task force**.

Marine expeditionary unit (special operations capable) – (Marine Corps) The Marine Corps standard, forward-deployed, sea-based expeditionary organization. The Marine expeditionary unit (special operations capable) (MEU[SOC]) is a Marine expeditionary unit (MEU), augmented with selected personnel and equipment, that is trained and equipped with an enhanced capability to conduct amphibious operations and a variety of specialized missions of limited scope and duration. These capabilities include specialized demolition, clandestine reconnaissance and surveillance, raids, in-extremis hostage recovery, and enabling operations for follow-on forces. The MEU(SOC) is not a special operations force but, when directed by the President/Secretary of Defense, the combatant commander, and/or other operational commander, may conduct limited special operations in extremis, when other forces are inappropriate or unavailable. In a joint or multinational environment, it may also contain other Service or multinational forces assigned or attached to the MAGTF. Also called **MEU(SOC)**. See also **aviation combat element; combat service support element; command element; ground combat element; Marine air-ground task force; Marine expeditionary brigade; Marine expeditionary force; Marine expeditionary force (forward); Marine expeditionary unit; special purpose Marine air-ground task force; task force**.

mark – (NATO) In artillery and naval fire support: a. a call for fire on a specified location in order to orient the observer/spotter or to indicate targets; b. to report the instant of optimum light on the target produced by illumination shells. [Note: the Army definition also applies to mortar fire.] See FM 6-30.

marking smoke – Smoke employed to relay prearranged communications on the battlefield. It is frequently used to identify targets, evacuation points, friendly perimeters, and so forth. (FM 3-50)

marshalling – (DOD, NATO) 1. The process by which units participating in an amphibious or airborne operation group together or assemble when feasible or move to temporary camps in the vicinity of embarkation points, complete preparations for combat, or prepare for loading. See FM 90-26. 2. The process of assembling, holding, and organizing supplies and/or equipment, especially vehicles of transportation, for onward movement. See FM 100-17. See also **staging area**.

marshalling area – (DOD) A location in the vicinity of a reception terminal or pre-positioned equipment storage site where arriving unit personnel, equipment, materiel, and accompanying supplies are reassembled, returned to the control of the unit commander, and prepared for onward movement. The joint complex commander designating the location will coordinate the use of the facilities with other allied commands and the host nation, and will provide life support to the units while in the marshalling area. See FM 100-17. (Marine Corps) 1. The general area in which unit preparation areas and departure airfields may be located and from which air movement is initiated. 2. In amphibious operations, the designated area in which, as part of the mounting process, units are reorganized for embarkation; vehicles and equipment are prepared to move directly to embarkation areas; and housekeeping facilities are provided for troops by other units. See also **marshalling**.

mask only – 1. A protective measure that provides some relief from mission-oriented protective posture (MOPP) gear for personnel who must work in a vapor- or aerosol-contaminated environment. Personnel must be within protective shelters (certain types of vans, tanks, or buildings) where the danger of transfer hazards is minimal. This posture is only used when the only threat is vapor. Mask only cannot be used when blister agents are present. 2. A protective measure used when the commander anticipates that his only chemical threat is from riot control agents. (FM 3-11.4)

mass – (DOD, NATO) 1. The concentration of combat power. 2. The military formation in which units are spaced at less than normal distances and intervals. (Army) One of the nine principles of war: Concentrate the effects of combat power at the decisive place and time. See also **principles of war**. (FM 3-0)

mass casualty – (DOD) Any large number of casualties produced in a relatively short period of time, usually as the result of a single incident such as a military aircraft accident, hurricane, flood, earthquake, or armed attack that exceeds logistical support capabilities. See also **casualty**. See FM 4-02.

massed fire – (DOD) 1. The fire of batteries of two or more ships directed against a single target. 2. Fire from a number of weapons directed at a single point or small area. See also **concentrated fire**. See FM 6-30.

materiel release confirmation – (DOD) A notification from a shipping or storage activity advising the originator of a materiel release order of the positive action taken on the order. It will also be used with appropriate shipment status document identifier codes as a reply to a follow-up initiated by the inventory control point. See FM 10-15.

materiel release order – (DOD) An order issued by an accountable supply system manager (usually an inventory control point or accountable depot or stock point) directing a nonaccountable activity (usually a storage site or materiel drop point) within the same supply distribution complex to release and ship materiel. See FM 10-15.

maximum effective range – (DOD, NATO) The maximum distance at which a weapon may be expected to be accurate and achieve the desired effect. [Note: the NATO definition replaces “effect” with “result.”] (Army) The distance from a weapon system at which a 50 percent probability of target hit is expected, or the tracer burnout range. (FM 3-22.1)

maximum range – (DOD, NATO) The greatest distance a weapon can fire without consideration of dispersion. (Army) The maximum distance a projectile or rocket can go at the optimum elevation of the weapon. (FM 3-22.1)

maximum rate of fire – The largest quantity of rounds physically or mechanically possible to fire through a weapon or weapon system in a specified period of time regardless of the damage that could be done to the system if this number of rounds was fired for a prolonged period of time. See also **sustained rate of fire**. (FM 3-21.91)

M-day – (DOD) The term used to designate the unnamed day on which full mobilization commences or is due to commence. See also **times**. See FM 101-5.

meaconing – (DOD, NATO) A system of receiving radio beacon signals and rebroadcasting them on the same frequency to confuse navigation. The meaconing stations cause inaccurate bearings to be obtained by aircraft and ground stations. See FM 34-1.

measurement and signature intelligence – (DOD) Scientific and technical intelligence obtained by quantitative and qualitative analysis of data (metric, angle, spatial, wavelength, time dependence, modulation, plasma, and hydromagnetic) derived from specific technical sensors for the purpose of identifying any distinctive features associated with the target, source, emitter, or sender measurement of the same. The detected feature may be either reflected or emitted. Also called **MASINT**. See also **intelligence; scientific and technical intelligence**. See FM 34-1.

medical countermeasures – Those measures taken to maintain soldier sustainability through the prevention and pretreatment of injury from nuclear, biological, and chemical (NBC) agent hazards; and following injury, those measures taken to treat NBC casualties and improve medical capability for diagnosis, physiological resuscitation, and continued medical management of NBC casualties. (FM 4-02.7)

medical evacuation – (Army/Marine Corps) The timely and efficient movement of the wounded, injured, or ill while providing en route medical care to and between medical treatment facilities. Also called **MEDEVAC**. See also **aeromedical evacuation; casualty evacuation**. (FM 4-02)

medical evacuees – (DOD) Personnel who are wounded, injured, or ill and must be moved to or between medical facilities. See FM 4-02.

medical intelligence – (DOD) That category of intelligence resulting from collection, evaluation, analysis, and interpretation of foreign medical, bio-scientific, and environmental information that is of interest to strategic planning and military medical planning and operations for the conservation of the fighting strength of friendly forces and the formation of assessments of foreign medical capabilities in both military and civilian sectors. Also called **MEDINT**. See also **intelligence**.

medical surveillance – (DOD) The ongoing systematic collection of health data essential to the evaluation, planning, and implementation of public health practice, closely integrated with the timely dissemination of data as required by higher authority. See FM 4-02.17.

medical threat – 1. A collective term used to designate all potential or continuing enemy actions and environmental situations that could possibly adversely affect the combat effectiveness of friendly forces, to include wounding, injuries, or sickness incurred while engaged in an operation. 2. A composite of all ongoing potential enemy actions and environmental conditions (diseases and nonbattle injuries) that may render a soldier combat ineffective. (FM 4-02)

medical treatment facility – (DOD) A facility established for the purpose of furnishing medical and/or dental care to eligible individuals. Also called **MTF**. See FM 4-02. (See page 5-22 for symbol.)

medical waste – Any waste that is generated in the diagnosis, treatment, or immunization of human beings or animals. (FM 3-100.4)

medium-scale map – (DOD) A map having a scale larger than 1:600,000 and smaller than 1:75,000. See also **large-scale map; map; small-scale map**. See FM 3-25.26.

meeting engagement – (DOD, NATO) A combat action that occurs when a moving force, incompletely deployed for battle, engages an enemy at an unexpected time and place. [Note:

the Army definition does not include the phrase “incompletely deployed for battle.”] See also **movement to contact**. See FM 3-0.

message – A procedure word meaning, “A message which requires recording is about to follow.” See also **procedure word**. (FM 24-19)

METT-TC – A memory aid used in two contexts: (1) In the context of information management, the major subject categories into which relevant information is grouped for military operations: mission, enemy, terrain and weather, troops and support available, time available, civil considerations. (2) In the context of tactics, the major factors considered during mission analysis. [Note: the Marine Corps uses METT-T: mission, enemy, terrain and weather, troops and support available-time available.] (FM 6-0)

military chemical compound – Chemical substance that has become generally accepted by the public for use in conventional war. Included are riot control agents, flame and smoke materials, and military herbicides. Excluded are chemical agents. (FM 3-9)

military crest – (Army/Marine Corps) An area on the forward slope of a hill or ridge from which maximum observation covering the slope down to the base of the hill or ridge can be obtained. (FM 3-25.26)

military deception – (DOD) Actions executed to deliberately mislead adversary military decisionmakers as to friendly military capabilities, intentions, and operations, thereby causing the adversary to take specific actions (or inactions) that will contribute to the accomplishment of the friendly mission. The five categories of military deception are as follows: a. **strategic military deception**—Military deception planned and executed by and in support of senior military commanders to result in adversary military policies and actions that support the originator’s strategic military objectives, policies, and operations. b. **operational military deception**—Military deception planned and executed by and in support of operational-level commanders to result in adversary actions that are favorable to the originator’s objectives and operations. Operational military deception is planned and conducted in a theater to support campaigns and major operations. c. **tactical military deception**—Military deception planned and executed by and in support of tactical commanders to result in adversary actions that are favorable to the originator’s objectives and operations. Tactical military deception is planned and conducted to support battles and engagements. d. **Service military deception**—Military deception planned and executed by the Services that applies to Service support to joint operations. Service military deception is designed to protect and enhance the combat capabilities of Service forces and systems. e. **military deception in support of operations security (OPSEC)**—Military deception planned and executed by and in support of all levels of command to support the prevention and inadvertent compromise of sensitive or classified activities, capabilities, or intentions. Deceptive OPSEC measures are designed to distract foreign intelligence away from, or to provide cover for, military operations and activities. See also **deception**. See FM 3-13.

military deception in support of operations security (OPSEC) (DOD) – Military deception planned and executed by and in support of all levels of command to support the prevention and inadvertent compromise of sensitive or classified activities, capabilities, or intentions. Deceptive OPSEC measures are designed to distract foreign intelligence away from, or to provide cover for, military operations and activities. See also **military deception**. See FM 3-13.

military environmental protection – The application and integration of all aspects of natural environmental considerations as they apply to the conduct of military operations. (FM 3-100.4)

military gamble – A decision in which a commander risks the force without a reasonable level of information about the outcome. (FM 6-0)

military grid reference system – (DOD, NATO) A system which uses a standard-scaled grid square, based on a point of origin on a map projection of the surface of the Earth in an accurate and consistent manner to permit either position referencing or the computation of direction and distance between grid positions. Also called **MGRS**. See FM 3-25.26.

military load classification – (DOD, NATO) A standard system in which a route, bridge, or raft is assigned class number(s) representing the load it can carry. Vehicles are also assigned number(s) indicating the minimum class of route, bridge, or raft they are authorized to use. Also called **MLC**. See also **route classification**. See FM 5-100.

military operations other than war – (DOD) Operations that encompass the use of military capabilities across the range of military operations short of war. These military actions can be applied to complement any combination of other instruments of national power and occur before, during, and after the war. Also called **MOOTW**. See also **counterdrug; counterinsurgency; domestic emergencies; foreign humanitarian assistance; peace operations; stability operations; support operations**. See FM 3-0.

military police response force – Those forces to which the commander assigns the mission of responding to and conducting operations to close with and destroy or delay attacking enemy forces beyond the capabilities of base defenses (Level II and Level III). (FM 3-19.1)

military strategy – (DOD) The art and science of employing the armed forces of a nation to secure the objectives of national policy by the application of force or the threat of force. See also **strategy**. See FM 3-0.

military symbol – (DOD) A graphic sign, usually on a map, display or diagram, to represent a particular military unit, installation, activity, or other item of military interest. See FM 1-02.

mine – (DOD, NATO) 1. In naval mine warfare, an explosive device laid in the water with the intention of damaging or sinking ships or of deterring shipping from entering an area. The term does not include devices attached to the bottoms of ships or to harbor installations by personnel operating underwater, nor does it include devices which explode immediately on expiration of a predetermined time after laying. 2. (DOD only) In land mine warfare, an explosive or material, normally encased, designed to destroy or damage ground vehicles, boats, or aircraft, or designed to wound, kill, or otherwise incapacitate personnel. It may be detonated by the action of its victim, by the passage of time, or by controlled means. (NATO only) In land mine warfare, an explosive munition designed to be placed under, on or near the ground or other surface area to be actuated by the presence, proximity or contact of a person, land vehicle, aircraft or boat, including landing craft. See also **mine warfare**. See FM 20-32. (See page 7-46 for symbol.)

minefield – (DOD, NATO) 1. In naval warfare, an area of water containing mines laid with or without a pattern. 2. (DOD only) In land warfare, an area of ground containing mines emplaced with or without a pattern. (NATO only) In land mine warfare, a defined area in which mines have been emplaced. See also **mine; mine warfare**. See FM 20-32. (See page 7-47 for symbol.)

minefield breaching – (DOD, NATO) In land mine warfare, the process of clearing a lane through a minefield under tactical conditions. See also **breach**; **lane**. See FM 20-32.

mine warfare – (DOD) The strategic, operational, and tactical use of mines and mine countermeasures. Mine warfare is divided into two basic subdivisions: the laying of mines to degrade the enemy's capabilities to wage land, air, and maritime warfare; and the countering of enemy-laid mines to permit friendly maneuver or use selected land or sea areas. Also called **MIW**. See FM 20-32.

minimum range – (DOD) 1. Least range setting of a gun at which the projectile will clear an obstacle or friendly troops between the gun and the target. 2. Shortest distance to which a gun can fire from a given position. 3. The range at which a projectile or fuse will be armed. See FM 3-22.1.

minimum-risk route – (DOD) A temporary corridor of defined dimensions recommended for use by high-speed, fixed-wing aircraft that presents the minimum known hazards to low-flying aircraft transiting the combat zone. Also called **MRR**. See FM 3-52. (See page 7-19 for symbol.)

minimum safe distance – The minimum distance in meters from desired ground zero at which a specific degree of personnel risk and vulnerability will not be exceeded with a 99 percent assurance. The minimum safe distance is the sum of the radius of safety and the buffer distance. Also called **MSD**. See also **desired ground zero**; **least separation distance**. (FM 100-30)

misfire – (DOD, NATO) 1. Failure to fire or explode properly. 2. Failure of a primer or the propelling charge of a round or projectile to function wholly or in part. See FM 6-40.

misinformation – Incorrect information from any source that is released for unknown reasons or to solicit a response or interest from a non-political or non-military target. (FM 3-13)

missing – (DOD) A casualty status for which the United States Code provides statutory guidance concerning missing members of the Military Services. Excluded are personnel who are in an absent without leave, deserter, or dropped-from-rolls status. A person declared missing is categorized as follows: a. **beleaguered**—The casualty is a member of an organized element that has been surrounded by a hostile force to prevent escape of its members. b. **besieged**—The casualty is a member of an organized element that has been surrounded by a hostile force, compelling it to surrender. c. **captured**—The casualty has been seized as the result of action of an unfriendly military or paramilitary force in a foreign country. d. **detained**—The casualty is prevented from proceeding or is restrained in custody for alleged violation of international law or other reason claimed by the government or group under which the person is being held. e. **missing**—The casualty is not present at his or her duty location due to apparent involuntary reasons and whose location is unknown. f. **missing in action**—The casualty is a hostile casualty, other than the victim of a terrorist activity, who is not present at his or her duty location due to apparent involuntary reasons and whose location is unknown. Also called **MIA**. See also **casualty**. See FM 4-02.

missing in action – (DOD) The casualty is a hostile casualty, other than the victim of a terrorist activity, who is not present at his or her duty location due to apparent involuntary reasons and whose location is unknown. Also called **MIA**. See also **casualty**; **missing**. See FM 4-02.

mission – (DOD) 1. The task, together with the purpose, that clearly indicates the action to be taken and the reason therefor. See FM 101-5. 2. In common usage, especially when applied to lower military units, a duty assigned to an individual or unit; a task. See FM 101-5. 3. The dispatching of one or more aircraft to accomplish one particular task. See FM 3-04.111.

mission command – The conduct of military operations through decentralized execution based upon mission orders for effective mission accomplishment. Successful mission command results from subordinate leaders at all echelons exercising disciplined initiative within the commander’s intent to accomplish missions. It requires an environment of trust and mutual understanding. (FM 6-0)

mission configured load – Load built inside a theater of operations for a specific mission, unit, or other purpose. Resources (personnel, equipment, and supplies) in a hub in the communications zone/intermediate staging base or corps area normally configured as mission configured loads. Also called **MCL**. (FM 4-0).

mission creep – Tangential efforts to assist in areas of concern unrelated to assigned duties that cripple efficient mission accomplishment. (FM 100-8)

mission, enemy, terrain and weather, troops and support available–time available and civil considerations – See **METT-TC**.

mission-essential task – A collective task in which an organization must be proficient to accomplish an appropriate portion of its wartime mission(s). (FM 7-0)

mission-essential task list – A compilation of collective mission-essential tasks an organization must perform successfully to accomplish its wartime mission(s). Also called **METL**. (FM 7-0)

mission orders – A technique for completing combat orders to allow subordinates maximum freedom of planning and action to accomplish missions that leaves the “how” of mission accomplishment to the subordinate. (FM 6-0)

mission-oriented protective posture – (DOD) A flexible system for protection against nuclear, biological, and chemical contamination. This posture requires personnel to wear only that protective clothing and equipment (mission-oriented protective posture gear) appropriate to the threat level, work rate imposed by the mission, temperature, and humidity. [Note: The Army definition adds: The seven levels of MOPP are shown in the following table.]

Table 1-1. Seven Levels of MOPP

MOPP/ Equipment	MOPP READY	MASK ONLY	MOPP ZERO	MOPP 1	MOPP 2	MOPP 3	MOPP 4
Mask	Carried	Worn	Carried	Carried	Carried	Worn ¹	Worn
Over-garment	Ready ³	Note	Available ⁴	Worn ¹	Worn ¹	Worn ¹	Worn
Vinyl Overboot	Ready ³	Note	Available ⁴	Available ⁴	Worn	Worn	Worn
Gloves	Ready ³	Note	Available ⁴	Available ⁴	Available ⁴	Available ⁴	Worn
Helmet, Protective Cover	Ready ³	Note	Available ⁴	Available ⁴	Worn	Worn	Worn
Chemical Protective Under-garment (CPU) ²	Ready ³	Note	Available ⁴	Worn ¹	Worn ¹	Worn ¹	Worn ¹
¹ In hot weather, coat or hood can be left open for ventilation. ² The CPU is worn under the BDU (primarily applies to SOF) or CVC coveralls. ³ Must be available to the soldier within two hours. Second set available in six hours. ⁴ Must be within arm's reach of soldier.							

[Note: Items can be readily available or available at the commander's discretion.] Also called **MOPP**. (FM 3-11.4)

mission statement – A short paragraph or sentence describing the task and purpose that clearly indicates the action to be taken and the reason thereof. It usually contains the elements of who, what, when, and where, and the reason thereof, but seldom specifies how. See also **commander's intent**; **operation order**; **operation plan**. (FM 101-5)

mission support site – A preselected area used as a temporary base or stopover point. The mission support site is used to increase the operational range within the joint special operations area. Also called **MSS**. (FM 3-05.201)

mixed minefield – (DOD, NATO) A minefield containing both antitank and antipersonnel mines. See also **minefield**. See FM 20-32.

mobile defense – (DOD) Defense of an area or position in which maneuver is used with organization of fire and utilization of terrain to seize the initiative from the enemy. (Army) A type of defensive operation that concentrates on the destruction or defeat of the enemy through a decisive attack by the striking force. (FM 3-0)

mobility – (DOD, NATO) A quality or capability of military forces which permits them to move from place to place while retaining the ability to fulfill their primary mission. (Army) Those activities that enable a force to move personnel and equipment on the battlefield without delays due to terrain or obstacles. (FM 5-100)

mobility corridor – (DOD) Areas where a force will be canalized due to terrain restrictions. They allow military forces to capitalize on the principles of mass and speed and are therefore relatively free of obstacles. See FM 34-130.

mobility/countermobility/survivability battlefield operating system – (Army) Mobility operations preserve the freedom of maneuver of friendly forces; countermobility operations deny mobility to enemy forces; survivability operations protect friendly forces from the effects of enemy weapon systems. See also **battlefield operating systems**. (FM 7-15)

mobility operations – Obstacle reduction by maneuver and engineer units to reduce or negate the effects of existing or reinforcing obstacles. The objective is to maintain freedom of movement for maneuver units, weapon systems, and critical supplies. See also **breach**; **countermobility operations**; **survivability operations**; **terrain reinforcement**. (FM 5-100)

mobilization – (DOD) 1. The act of assembling and organizing national resources to support national objectives in time of war or other emergencies. 2. The process by which the Armed Forces or part of them are brought to a state of readiness for war or other national emergency. This includes activating all or part of the Reserve Components as well as assembling and organizing personnel, supplies and materiel. Mobilization of the Armed Forces includes, but is not limited to, the following categories: a. **selective mobilization**—Expansion of the active Armed Forces resulting from action by Congress and/or the President to mobilize Reserve Component units, Individual Ready Reservists, and the resources needed for their support to meet the requirements of a domestic emergency that is not the result of an enemy attack. b. **partial mobilization**—Expansion of the active Armed Forces resulting from action by Congress (up to full mobilization) or by the President (not more than 1,000,000 for not more than 24 consecutive months) to mobilize Ready Reserve Component units, individual reservists, and the resources needed for their support to meet the requirements of war or other national emergency involving an external threat to the national security. c. **full mobilization**—Expansion of the active Armed Forces resulting from action by Congress and the President to mobilize all Reserve Component units in the existing approved force structure, as well as all individual reservists, retired military personnel, and the resources needed for their support to meet the requirements of a war or other national emergency involving an external threat to the national security. Reserve personnel can be placed on active duty for the duration of the emergency plus six months. d. **total mobilization**—Expansion of the active Armed Forces resulting from action by Congress and the President to organize and/or generate additional units or personnel beyond the existing force structure, and the resources needed for their support, to meet the total requirements of a war or other national emergency involving an external threat to the national security. Also called **MOB**. See FM 100-17.

moderate nuclear risk – (NATO) A degree of risk where anticipated effects are tolerable, or at worst a minor nuisance. See also **degree of risk**; **emergency risk (nuclear)**; **negligible risk (nuclear)**. See FM 100-30.

mode of transport – (DOD) The various modes used for movement. For each mode, there are several means of transport. They are: a. inland surface transportation (rail, road, and inland waterway); b. sea transport (coastal and ocean); c. air transportation; and d. pipelines. See FM 55-1.

monitoring – (DOD, NATO) 1. The act of listening, carrying out surveillance on, and/or recording the emissions of one's own or allied forces for the purpose of maintaining and improving procedural standards and security, or for reference, as applicable. See FM 34-1. 2. The act of listening, carrying out surveillance on, and/or recording of enemy emissions for intelligence purposes. See FM 34-1. 3. The act of detecting the presence of radiation and the measurement thereof with radiation measuring instruments. Also called **radiological monitoring**. See FM 3-3-1. (Army) 1. An element of assessment: continuous observation of the common operational picture to identify indicators of opportunities for success, threats to the force, and gaps in information. (FM 6-0) 2. The assessment of emissions and ambient air quality conditions. (FM 3-100.4)

more to follow – A procedure word meaning “Transmitting station has additional traffic for the receiving station.” See also **procedure word**. (FM 24-19)

mortuary affairs – (DOD) Covers the search for, recovery, identification, preparation, and disposition of remains or persons for whom the Services are responsible by status and Executive Order. See also **graves registration**. See FM 10-64. (See page 5-21 for symbol.)

mosaic – (DOD, NATO) An assembly of overlapping photographs that have been matched to form a continuous photographic representation of a portion of the surface of the Earth. See FM 3-25.26.

movement bid – A request for clearance to move on main supply routes to other controlled routes for which a clearance is required prior to initiating the movement. (FM 4-01.30)

movement control – (DOD, NATO) 1. The planning, routing, scheduling, and control of personnel and cargo movements over lines of communications. 2. An organization responsible for the planning, routing, scheduling, and control of personnel and cargo movements over lines of communications. [Note: the Army definition adds “Organizations responsible for these functions are movement control teams, movement control centers, and movement control activities.”] Also called **movement control center/MCC**. See also **line of communications**; **nonunit-related cargo**. (FM 4-01.30)

movement control center (MCC) – See **movement control**.

movement credit – (DOD, NATO) The allocation granted to one or more vehicles in order to move over a controlled route in a fixed time according to movement instructions. See FM 4-01.30.

movement formation – 1. An ordered arrangement of troops and/or vehicles for a specific purpose. 2. An ordered arrangement of two or more units, aircraft, or ships proceeding together under a commander. Types of formations include: box, column, diamond, line, vee, wedge, and echelon (right or left). See also **box formation**; **column formation**; **diamond formation**; **echelon formation**; **line formation**; **vee formation**; **wedge formation**. (FM 3-90)

movement order – (DOD) An order issued by a commander covering the details for a move of the command. See FM 101-5.

movement phase – (DOD) In amphibious operations, the period during which various elements of the amphibious force move from points of embarkation to the operational area. This move may be via rehearsal, staging, or rendezvous areas. The movement phase is completed when the various elements of the amphibious force arrive at their assigned positions in the operational area. See also **amphibious force**; **amphibious operation**.

movement requirement – (DOD) A stated movement mode and time-phased need for transport of units, personnel, and/or materiel from a specified origin to a specified destination. See FM 4-01.30.

movement schedule – (DOD) A schedule developed to monitor or track a separate entity, whether it is a force requirement, cargo or personnel increment, or lift asset. The schedule reflects the assignment of specific lift resources (such as an aircraft or ship) that will be used to move the personnel and cargo included in a specific movement increment. Arrival and departure times at ports of embarkation, etc., are detailed to show a flow and workload at

each location. Movement schedules are detailed enough to support plan implementation. See FM 4-01.30.

movement table – (DOD, NATO) A table giving detailed instructions or data for a move. When necessary it will be qualified by the words road, rail, sea, air, etc. to signify the type of movement. Normally issued as an annex to a movement order or instruction. See also **movement order**. See FM 4-01.30.

movement to contact – (DOD) A form of the offensive designed to develop the situation and to establish or regain contact. [Note: the NATO term is “advance to contact.”] See also **meeting engagement**; **offensive operations**; **reconnaissance in force**. See FM 3-0.

multinational operations – (DOD) A collective term to describe military actions conducted by forces of two or more nations, usually undertaken within the structure of a coalition or alliance. See also **alliance**; **coalition**. See FM 100-8.

multi-spectral imagery – (DOD, NATO) The image of an object obtained simultaneously in a number of discrete spectral bands. Also called **MSI**. See FM 34-3.

multi-spectral obscurant – An obscurant that blocks or attenuates more than two portions of the electromagnetic spectrum (such as visual, infrared, and millimeter wave). (FM 3-50)

munition – (DOD, NATO) A complete device charged with explosives, propellants, pyrotechnics, initiating composition, or nuclear, biological, or chemical material for use in military operations, including demolitions. Certain suitably modified munitions can be used for training, ceremonial, or nonoperational purposes. Also called **ammunition**. [Note: In common usage, “munitions” [plural] can be military weapons, ammunition, and equipment.] See FM 20-32.

mutual support – (DOD, NATO) That support which units render each other against an enemy because of their assigned tasks, their positions relative to each other and to the enemy, and inherent capabilities. See also **direct support**; **support**. See FM 3-90.

—N—

named area of interest – (DOD) The geographical area where information that will satisfy a specific information requirement can be collected. Named areas of interest are usually selected to capture indications of adversary courses of action, but also may be related to conditions of the battlespace. See FM 3-90. (Marine Corps) A point or area along a particular avenue of approach through which enemy activity is expected to occur. Activity or lack of activity within a named area of interest will help to confirm or deny a particular enemy course of action.. Also called **NAI**. See also **area of interest**; **event template**. (See page 7-35 for symbol.)

nap-of-the-earth flight – See **terrain flight**.

national command – (NATO) A command that is organized by, and functions under the authority of, a specific nation. It may or may not be placed under a NATO commander. See also **command**. See FM 100-8.

national intelligence support team – (DOD) A nationally sourced team composed of intelligence and communications experts from either Defense Intelligence Agency, Central Intelligence Agency, National Security Agency, or any combination of these agencies. Also called **NIST**. See also **intelligence**. See FM 34-1.

natural decontamination – The process of decontamination by natural evaporation or decomposition of the chemical agent. (FM 3-5)

natural disaster – (DOD) All domestic emergencies except those created as a result of enemy attack or civil disturbance. See **domestic emergencies**. See FM 3-07.

natural environment – The human ecosystem, including both the physical and biological systems that provide resources (clean air, clean water, healthy surroundings, sufficient food), necessary to sustain productive human life. Included in the natural environment are manmade structures, such as water and waste-water treatment facilities, and natural/cultural resources. (FM 3-100.4)

naval gunfire support – (DOD) Fire provided by Navy surface gun systems in support of a unit or units tasked with achieving the commander's objectives. A subset of naval surface fire support. Also called **NGFS**. See also **amphibious operation**; **naval surface fire support**. See FM 6-20-30.

naval surface fire support – (DOD) Fire provided by Navy surface gun and missile systems in support of a unit or units tasked with achieving the commander's objectives. Also called **NSFS**. See FM 6-20-30.

NBC defense – See **nuclear, biological, and chemical defense**.

NBC monitoring – See **nuclear, biological, and chemical monitoring**.

NBC reconnaissance – See **nuclear, biological, and chemical reconnaissance**.

NBC surveillance – See **nuclear, biological, and chemical surveillance**.

NBC survey – See **nuclear, biological, and chemical survey**.

N-day – (DOD) The unnamed day an active duty unit is notified for deployment or redeployment. See also **times**. See FM 101-5.

need to know – (DOD) A criterion used in security procedures that requires the custodians of classified information to establish, prior to disclosure, that the intended recipient must have access to the information to perform his or her official duties. See FM 34-1.

neglect – (NATO) In artillery, mortar, and naval gunfire support, a report to the observer/spotter to indicate that the last round(s) was fired with incorrect data and that the round(s) will be fired again using correct data. See FM 6-30.

negligible risk (nuclear) – (DOD) A degree of risk where personnel are reasonably safe, with the exceptions of dazzle or temporary loss of night vision. See also **degree of risk (nuclear)**; **emergency risk (nuclear)**; **moderate risk**. See FM 100-30.

negligible risk levels – Level of contamination that will cause mild incapacitation among no more than five percent of unprotected soldiers who operate for twelve continuous hours within one meter of contaminated surfaces. (FM 3-11)

nerve agent – (DOD, NATO) A potentially lethal chemical agent which interferes with the transmission of nerve impulses. See FM 3-9.

nested concept – The means to achieve unity of purpose whereby each succeeding echelon's concept is included in the other. (FM 101-5)

net control station – (DOD) A communications station designated to control traffic and enforce circuit discipline within a given net. Also called **NCS**. See FM 11-32.

neutral – (DOD) In combat and combat support operations, an identity applied to a track whose characteristics, behavior, origin, or nationality indicate that it is neither supporting nor opposing friendly forces. (Army) 1. An individual, group of individuals, organization, or nation that is not hostile to, or in any way supportive of, only one belligerent force in a hostile environment. (FM 100-8) 2. A meteorological condition that exists when conditions are intermediate between lapse and inversion: when the temperatures of the ground are approximately the same temperature of the lower air up to four meters above it. This condition has light to moderate winds and slight turbulence, and is considered average for release of chemical weapons. (FM 3-6) See also **hostile; suspect; unknown**. (See page 4-3 for symbol.)

neutrality – (DOD) In international law, the attitude of impartiality, during periods of war, adopted by third states toward a belligerent and subsequently recognized by the belligerent, which creates rights and duties between the impartial states and the belligerent. In a United Nations enforcement action, the rules of neutrality apply to impartial members of the United Nations except so far as they are excluded by the obligation of such members under the United Nations Charter. See FM 3-07.

neutralization – (DOD, NATO) In mine warfare, a mine is said to be neutralized when it has been rendered, by external means, incapable of firing on passage of a target, although it may remain dangerous to handle. See FM 20-32.

neutralize – (DOD) 1. As applies to military operations, to render ineffective or unusable. 2. To render enemy personnel or material incapable of interfering with a particular operation. See FM 3-90. 3. To render safe mines, bombs, missiles, and booby traps. See FM 5-250. 4. To make harmless anything contaminated with a chemical agent. See FM 3-9. (See page A-4 for symbol.)

no-fire area – (DOD) A land area, designated by the appropriate commander, into which fires or their effects are prohibited. (Marine Corps) A designated area into which neither fires nor effects of fires will occur. Two exceptions occur: a. the establishing headquarters asks for or approves fire or b. an enemy force takes refuge in the area, poses a major threat, and there is insufficient time to clear the fires needed to defend the friendly force. Also called **NFA**. See also **fires**. See FM 3-90. (See page 7-37 for symbol.)

nonalignment – (DOD) The political attitude of a state that does not associate or identify itself with the political ideology or objective espoused by other states, groups of states, or international causes, or with the foreign policies stemming therefrom. It does not preclude involvement, but expresses the attitude of no precommitment to a particular state (or bloc) or policy before a situation arises. See FM 41-10.

nonbattle injury – (DOD) A person who becomes a casualty due to circumstances not directly attributable to hostile action or terrorist activity. Also called **NBI**. See FM 4-02.

noncombatant – 1. An individual, in an area of combat operations, who is not armed and is not participating in any activity in support of any of the factions or forces involved in combat.

(FM 41-10) 2. An individual, such as chaplain or medical personnel, whose duties do not involve combat.

noncombatant evacuation operations – (DOD) Operations directed by the Department of State, the Department of Defense, or other appropriate authority whereby noncombatants are evacuated from foreign countries when their lives are endangered by war, civil unrest, or natural disaster to safe havens or to the United States. Also called **NEO**. See also **evacuation; operation**. See FM 3-07.

noncontiguous area of operations – When one or more of the commander’s subordinate forces do not share a common boundary. (FM 3-90)

nongovernmental organizations – (DOD) Transnational organizations of private citizens that maintain a consultative status with the Economic and Social Council of the United Nations. Nongovernmental organizations may be professional associations, foundations, multinational businesses, or simply groups with a common interest in humanitarian assistance activities (development and relief). “Nongovernmental organizations” is a term normally used by non-United States organizations. See also **military operations other than war; stability operations; support operations**. Also called **NGOs**. See FM 3-07.

nonlethal fires – Any fires that do not directly seek the physical destruction of the intended target and are designed to impair, disrupt, or delay the performance of enemy operational forces, functions, and facilities. Psychological operations, electronic warfare (jamming), and other command and control countermeasures are all nonlethal fire options. See also **nonlethal weapons**. (FM 6-20)

nonlethal weapons – (DOD) Weapons that are explicitly designed and primarily employed so as to incapacitate personnel or materiel, while minimizing fatalities, permanent injury to personnel and undesired damage to property and the environment. a. Unlike conventional lethal weapons that destroy their targets through blast, penetration, and fragmentation, nonlethal weapons employ means other than gross physical destruction to prevent the target from functioning. b. Nonlethal weapons are intended to have one, or both, of the following characteristics: (1) They have relatively reversible effects on personnel or materiel. (2) They affect objects differently within their area of influence. See FM 6-20.

nonpersistent agent – (DOD) A chemical agent that, when released, dissipates and/or loses its ability to cause casualties after 10 to 15 minutes. See FM 3-11.

non-unit-related cargo – (DOD) All equipment and supplies requiring transportation to an operational area, other than those identified as the equipment or accompanying supplies of a specific unit (e.g., resupply, military support for allies, and support for nonmilitary programs, such as civil relief). Also called **NURC**. See FM 4-0.

notice of violation – Formal written document provided to an installation by a regulatory agency as a result of environmental noncompliance. Also called **NOV**. (FM 3-100.4)

notice to airmen – (DOD, NATO) A notice [Note: the NATO definition adds: “distributed by means of telecommunication”] containing information concerning the establishment, condition, or change in any aeronautical facility, service, procedures, or hazard, the timely knowledge of which is essential to personnel concerned with flight operations. Also called **NOTAM**. See FM 3-04.111.

not mission capable, maintenance – (DOD) Material condition indicating that systems and equipment are not capable of performing any of their assigned missions because of maintenance requirements. Also called **NMCM**. See also **not mission capable, supply**. See FM 4-30.3.

not mission capable, supply – (DOD) Material condition indicating that systems and equipment are not capable of performing any of their assigned missions because of maintenance work stoppage due to a supply shortage. Also called **NMCS**. See also **not mission capable, maintenance**. See FM 4-30.3.

nuclear, biological, and chemical defense – (DOD) Defensive measures that enable friendly forces to survive, fight, and win against enemy use of nuclear, biological and chemical (NBC) weapons and agents. US forces apply NBC defensive measures before and during integrated warfare. In integrated warfare, opposing forces employ nonconventional weapons along with conventional weapons (NBC weapons are nonconventional). Also called **NBC defense**. See also **integrated warfare**. See FM 3-11.

nuclear, biological, and chemical monitoring – A protective measure performed by units to ensure advanced early warning for contamination hazards from the use of weapons of mass destruction. It primarily includes sensor warnings of the presence of primarily nuclear or chemical materials. Monitoring may be either periodic or continuous. Also called **NBC monitoring**. (FM 3-3-1)

nuclear, biological, and chemical reconnaissance – A mission undertaken to obtain information (of military significance) about unknown NBC contamination pertaining to routes, areas, and zones. This information confirms or denies the presence or absence of NBC attacks or NBC hazards through the use of detection and identification equipment or visual observation, or by the collection of samples in any specified location or region by using NBC detection, identification, and sampling equipment. Also called **NBC reconnaissance**. (FM 3-19)

nuclear, biological, and chemical surveillance – The systematic observation of aerospace, surface, or subsurface areas, places, persons, or things by visual, electronic, mechanical, or other means for NBC attacks or hazards. Also called **NBC surveillance**. (FM 3-19)

nuclear, biological, and chemical survey – The collection of detailed information (of military significance) pertaining to specific contaminated areas to determine the type of contamination and degree (extent or intensity) of the NBC hazard. This survey typically determines the outer boundaries of the hazard area. Also called **NBC survey**. (FM 3-19)

nuclear, biological, and chemical warning and reporting system – The primary means of warning units of an actual or predicted nuclear, chemical, and biological (NBC) hazard. Units use the nuclear, biological, and chemical warning and reporting system as battlefield intelligence to send and receive NBC 1-6 reports. Also called **NBCWRS**. (FM 3-11)

nuclear collateral damage – (DOD) Undesired damage or casualties produced by the effects from friendly nuclear weapons. [Note: the NATO term is “nuclear collateral effects.” See AAP-6.] See FM 100-30.

nuclear environment – The presence or implication of any nuclear-capable system before, during, or after nuclear weapons employment by either friendly or enemy forces. (FM 100-30).

nuclear strike warning – (DOD, NATO) A warning of impending friendly or suspected enemy nuclear attack. See also **strike warning**. See FM 100-30.

nuclear yields – (DOD) The energy released in the detonation of a nuclear weapon measured in terms of kilotons or megatons of trinitrotoluene required to produce the same energy release. Yields are categorized as follows:

very low—less than 1 kiloton;

low—1 kiloton to 10 kilotons;

medium—over 10 kilotons to 50 kilotons;

high—over 50 kilotons to 500 kilotons;

very high—over 500 kilotons.

(FM 100-30)

nuisance minefield – (DOD) A minefield laid to delay and disorganize the enemy and to hinder the use of an area or route. (Army) In landmine warfare, a minefield that imposes caution on enemy forces and disrupts, delays, and sometimes weakens or destroys follow-on echelons. See also **minefield**. (FM 20-32)



objective – (DOD) 1. The clearly defined, decisive, and attainable goals towards which every military operation should be directed. 2. The specific target of the action taken (for example, a definite terrain feature, the seizure or holding of which is essential to the commander's plan, or, an enemy force or capability without regard to terrain features). (NATO) The physical object of the action taken, e.g., a definite tactical feature, the seizure and/or holding of which is essential to the commander's plan. (Army) 1. One of the nine principles of war: Direct every military action toward a clearly defined, decisive, and attainable objective. (FM 3-0) 2. A location on the ground used to orient operations, phase operations, facilitate changes of direction, and provide for unity of effort. (FM 3-90) See also **decisive point**; **principles of war**; **target**. (See page 7-32 for symbol.)

obscurant – A chemical agent that decreases the energy available for the functions of seekers, trackers, and vision enhancement devices. (FM 3-50)

obscuration – The effects of weather, battlefield dust, and debris, or the use of smoke munitions to hamper observation and target-acquisition capability or to conceal activities or movement. (FM 3-50)

obscuration smoke – Smoke placed on or near enemy positions to minimize enemy observation both within and beyond the position area. (FM 3-50)

observation post – (DOD, NATO) A position from which military observations are made, or fire directed and adjusted, and which possesses appropriate communications; may be airborne. Also called **OP**. See FM 3-90. (See page 7-26 for symbol.)

observed fire – (DOD, NATO) Fire for which the point of impact or burst can be seen by an observer. The fire can be controlled and adjusted on the basis of observation. See also **fire**. See FM 6-30.

observer-target line – (DOD, NATO) An imaginary straight line from the observer/spotter to the target. See FM 6-30.

- obstacle** – (DOD) Any obstruction designed or employed to disrupt, fix, turn, or block the movement of an opposing force, and to impose additional losses in personnel, time, and equipment on the opposing force. Obstacles can be natural, manmade, or a combination of both. See also **reinforcing obstacles**. See FM 90-7. (See page 7-45 for symbol.)
- obstacle belt** – (DOD) A brigade-level command and control measure, normally given graphically, to show where within an obstacle zone the ground tactical commander plans to limit friendly obstacle employment and focus the defense. It assigns an intent to the obstacle plan and provides the necessary guidance on the overall effect of obstacles within a belt. See also **obstacle**. See FM 3-90. (See page 7-45 for symbol.)
- obstacle control measures** – Specific measures that simplify the granting of obstacle-emplacing authority while providing obstacle control. (FM 3-90)
- obstacle groups** – One or more individual obstacles grouped to provide a specific obstacle effect. (FM 3-90)
- obstacle line** – A conceptual control measure used at battalion or brigade level to show placement intent without specifying a particular type of linear obstacle. (FM 90-7) (See page 7-45 for symbol.)
- obstacle restricted areas** – (DOD) A command and control measure used to limit the type or number of obstacles within an area. See also **obstacle**. See FM 90-7. (See page 7-50 for symbol.)
- obstacle zone** – (DOD) A division-level command and control measure, normally done graphically, to designate specific land areas where lower echelons are allowed to employ tactical obstacles. See also **countermobility operations**; **obstacle**. See FM 3-90. (See page 7-45 for symbol.)
- occupy** – A tactical mission task that involves a force moving into an area so that it can control the entire area. Both the force's movement to and occupation of the area occur without enemy opposition. (FM 3-90) (See page A-4 for symbol.)
- offensive** – One of the nine principles of war: Seize, retain, and exploit the initiative. See also **principles of war**. (FM 3-0)
- offensive air support** – (Army) That part of tactical air support of land operations that consists of tactical air reconnaissance and close air support, which are conducted in direct support of land operations. (FM 3-04.111) (Marine Corps) Those air operations conducted against enemy installations, facilities, and personnel to directly assist the attainment of MAGTF objectives by the destruction of enemy resources or the isolation of the enemy's military forces. Also called **OAS**.
- offensive counterair** – (DOD) Offensive operations to destroy, disrupt, or neutralize enemy aircraft, missiles, launch platforms, and their supporting structures and systems both before and after launch, but as close to their source as possible. Offensive counterair operations range throughout the enemy territory and are generally conducted at the initiative of friendly forces. These operations include attack operations, fighter sweep, escort, and suppression of enemy air defenses. Also called **OCA**. See also **counterair**; **defensive counterair**; **operation**. See FM 44-100.

offensive counterspace – Combat operations conducted against enemy systems (or their support systems) designed to operate in space (e.g., a directed-energy weapon operating from an aircraft or ground location that is used to destroy enemy satellites). Also called **OCS**. (FM 44-100)

offensive information operations – (DOD) The integrated use of assigned and supporting capabilities and activities, mutually supported by intelligence, to affect adversary decisionmakers to achieve or promote specific objectives. These capabilities and activities include, but are not limited to, operations security, military deception, psychological operations, electronic warfare, physical destruction, and special information operations, and could also include computer network attack. (Army) The integrated use of assigned and supporting capabilities and activities, mutually supported by intelligence, to affect enemy decisionmakers or to influence others to achieve or promote specific objectives. See also **computer network attack; defensive information operations; electronic warfare; information operations; intelligence; military deception; operations security; psychological operations**. (FM 3-0)

offensive operations – Operations which aim at destroying or defeating an enemy. Their purpose is to impose US will on the enemy and achieve decisive victory. (FM 3-0)

on-call – (DOD) 1. Term used to signify that a prearranged concentration, air strike, or final protective fire may be called for. 2. Preplanned, identified force or materiel requirements without designated time-phased and destination information. Such requirements will be called forward upon order of competent authority. See also **call for fire**. See FM 6-30.

on-call resupply – (DOD) A resupply mission planned before insertion of a special operations team into the operations area but not executed until requested by the operating team. See also **emergency resupply**. See FM 100-25.

on-call target – (NATO) In artillery and naval fire support, a planned target other than a scheduled target on which fire is delivered when requested. [Note: the Army definition also applies to mortar fire.] See FM 6-30.

one day's supply – (DOD, NATO) A unit or quantity of supplies adopted as a standard of measurement, used in estimating the average daily expenditure under stated conditions. It may also be expressed in terms of a factor, e.g., rounds of ammunition per weapon per day. Also called **day of supply**. See 4-0.

on-order mission – A mission to be executed at an unspecified time in the future. A unit with an on-order mission is a committed force. The commander envisions task execution in the concept of operations; however, he may not know the exact time or place of execution. Subordinate commanders develop plans and orders and allocate resources, task-organize, and position forces for execution. See also **be-prepared mission**. (FM 101-5)

operating level of supply – (DOD) The quantities of materiel required to sustain operations in the interval between requisitions or the arrival of successive shipments. These quantities should be based on the established replenishment period (monthly, quarterly, etc.). See FM 4-0.

operation – (DOD, NATO) 1. A military action or the carrying out of a strategic, operational, tactical, service, training, or administrative military mission. 2. The process of carrying on combat, including movement, supply, attack, defense, and maneuvers needed to gain the objectives of any battle or campaign. See FM 3-0.

operational approach – The manner in which a commander attacks the enemy center of gravity. See also **direct approach; indirect approach**. (FM 3-0)

operational art – (DOD) The employment of military forces to attain strategic and/or operational objectives through the design, organization, integration, and conduct of strategies, campaigns, major operations, and battles. Operational art translates the joint force commander's strategy into operational design, and, ultimately, tactical action, by integrating the key activities at all levels of war. See also **strategic level of war; tactical level of war**. See FM 3-0.

operational command – (NATO) The authority granted to a commander to assign missions or tasks to subordinate commanders, to deploy units, to reassign forces, and to retain or delegate operational and/or tactical control as the commander deems necessary. Note: It does not of itself include responsibility for administration. [Note: this term is only used within the context of NATO operations.] Also called **OPCOM**. See also **operational control**. See FM 100-8.

operational control – (DOD) Command authority that may be exercised by commanders at any echelon at or below the level of combatant command. Operational control is inherent in combatant command (command authority) and may be delegated within the command. When forces are transferred between combatant commands, the command relationship the gaining commander will exercise (and the losing commander will relinquish) over these forces must be specified by the Secretary of Defense. Operational control is the authority to perform those functions of command over subordinate forces involving organizing and employing commands and forces, assigning tasks, designating objectives, and giving authoritative direction necessary to accomplish the mission. Operational control includes authoritative direction over all aspects of military operations and joint training necessary to accomplish the missions assigned to the command. Operational control should be exercised through the commanders of subordinate organizations. Normally this authority is exercised through subordinate joint force commanders and Service and/or functional component commanders. Operational control normally provides full authority to organize commands and forces and to employ those forces as the commander in operational control considers necessary to accomplish assigned missions; it does not, in and of itself, include authoritative direction for logistics or matters of administration, discipline, internal organization, or unit training. Also called **OPCON**. See also **assign; combatant command; combatant command (command authority); detachment; operational command; tactical control**. See FM 3-0.

operational decontamination – (DOD, NATO) Decontamination carried out by an individual and/or a unit, restricted to specific parts of operationally essential equipment, materiel, and/or working areas, in order to minimize contact and transfer hazards and to sustain operations. This may include decontamination of the individual beyond the scope of immediate decontamination, as well as decontamination of mission-essential spares and limited terrain decontamination. See also **decontamination; immediate decontamination; thorough decontamination**. See FM 3-5.

operational environment – (DOD) A composite of the conditions, circumstances, and influences which affect the employment of military forces and bear on the decisions of the unit commander. Some examples are as follows: a. **permissive environment**—Operational environment in which host country military and law enforcement agencies have control as well as the intent and capability to assist operations that a unit intends to conduct. b. **uncertain environment**—Operational environment in which host government forces,

whether opposed or receptive to operations that a unit intends to conduct, do not have totally effective control of the territory and population in the intended operational area. c. **hostile environment**—Operational environment in which hostile forces have control and the intent and capability to effectively oppose or react to the operations a unit intends to conduct. See FM 3-07.

operational fires – The operational-level commander’s application of nonlethal and lethal weapons effects to accomplish objectives during the conduct of a campaign or major operation. (FM 3-0)

operational framework – The arrangement of friendly forces and resources in time, space, and purpose with respect to each other and the enemy or situation. It consists of the area of operations, battlespace, and battlefield organization. See also **area of operations; battlefield organization; battlespace**. (FM 3-0)

operational level of war – (DOD) The level of war at which campaigns and major operations are planned, conducted, and sustained to accomplish strategic objectives within theaters or operational areas. Activities at this level link tactics and strategy by establishing operational objectives needed to accomplish the strategic objectives, sequencing events to achieve the operational objectives, initiating actions, and applying resources to bring about and sustain these events. These activities imply a broader dimension of time or space than do tactics; they ensure the logistic and administrative support of tactical forces, and provide the means by which tactical successes are exploited to achieve strategic objectives. See also **strategic level of war; tactical level of war**. See FM 3-0.

operationally ready – (DOD) 1. A unit, ship, or weapon system capable of performing the missions or functions for which organized or designed. Incorporates both equipment readiness and personnel readiness. 2. Personnel available and qualified to perform assigned missions or functions. See FM 63-2.

operational military deception – (DOD) Military deception planned and executed by and in support of operational-level commanders to result in adversary actions that are favorable to the originator’s objectives and operations. Operational military deception is planned and conducted in a theater to support campaigns and major operations. See also **military deception**. See FM 3-13.

operational pause – A deliberate halt taken to extend operational reach or prevent culmination. (FM 3-0)

operational picture – A single display of relevant information within a commander’s area of interest. (FM 3-0)

operational psychological activities – Psychological operations that are conducted prior to, during war or conflict, and at the conclusion of open hostilities in a defined geographic area to promote the effectiveness of the area command’s campaigns and strategies. (FM 3-05.30)

operational reach – (DOD) The distance and duration across which a unit can successfully employ military capabilities. See FM 3-0.

operational readiness float – (Army) A quantity of selected class II and VII items authorized for use by direct support maintenance units in exchange with supported units if a like item cannot be repaired in a timely manner. (FM 63-2). (Marine Corps) A pool of mission-essential, maintenance significant end items used to provide replacement items for

unserviceable, repairable end items which cannot be repaired in time to meet an operational commitment. Also called **ORF**.

operational reserve – (DOD) An emergency reserve of men and/or materiel established for the support of a specific operation. See FM 3-0.

operation annexes – (DOD) Those amplifying instructions that are of such a nature, or are so voluminous or technical, as to make their inclusion in the body of the plan or order undesirable. See FM 101-5.

operation exposure guide – (DOD) The maximum amount of nuclear radiation that the commander considers a unit may be permitted to receive while performing a particular mission or missions. [Note: the Army term is “operational exposure guidance.”] Also called **OEG**. See also **radiation status**. See FM 3-3-1.

operation order – (DOD, NATO) A directive [Note: the NATO definition adds “usually formal”] issued by a commander to subordinate commanders for the purpose of effecting the coordinated execution of an operation. [Note: Army definition adds, “Also called the five-paragraph field order, it contains as a minimum a description of the task organization, situation, mission, execution, administrative and logistics support, and command and signal for the specified operation.”] Also called **OPORD**. See also **operation plan**. See FM 101-5.

operation plan – (DOD) Any plan, except for the Single Integrated Operational Plan, for the conduct of military operations. Plans are prepared by combatant commanders in response to requirements established by the Chairman of the Joint Chiefs of Staff and by commanders of subordinate commands in response to requirements tasked by the establishing unified commander. Operation plans are prepared in either a complete format (OPLAN) or as a concept plan (CONPLAN). The CONPLAN can be published with or without a time-phased force and deployment data (TPFDD) file. a. **OPLAN**—An operation plan for the conduct of joint operations that can be used as a basis for development of an operation order (OPORD). An OPLAN identifies the forces and supplies required to execute the CINC’s Strategic Concept and a movement schedule of these resources to the theater of operations. The forces and supplies are identified in TPFDD files. OPLANs will include all phases of the tasked operation. The plan is prepared with the appropriate annexes, appendixes, and TPFDD files as described in the Joint Operation Planning and Execution System manuals containing planning policies, procedures, and formats. b. **CONPLAN**—An operation plan in an abbreviated format that would require considerable expansion or alteration to convert it into an OPLAN or OPORD. A CONPLAN contains the CINC’s Strategic Concept and those annexes and appendixes deemed necessary by the combatant commander to complete planning. Generally, detailed support requirements are not calculated and TPFDD files are not prepared. c. **CONPLAN with TPFDD**—A CONPLAN with TPFDD is the same as a CONPLAN except that it requires more detailed planning for phased deployment of forces. (Army) Any plan for the preparation, execution, and assessment of military operations. Also called **OPLAN**. See also **operation order; time-phased force and deployment data**. (FM 101-5)

operations process – The activities performed during operations: plan, prepare, and execute with continuous assessment. (FM 6-0)

operations security – (DOD) A process of identifying critical information and subsequently analyzing friendly actions attendant to military operations and other activities to: a. identify those actions that can be observed by adversary intelligence systems; b. determine indicators

hostile intelligence systems might obtain that could be interpreted or pieced together to derive critical information in time to be useful to adversaries; and c. select and execute measures that eliminate or reduce to an acceptable level the vulnerabilities of friendly actions to adversary exploitation. [Note: the Army replaces “critical information” with “essential elements of friendly information.”] Also called **OPSEC**. See FM 3-13.

operator’s spraydown – Decontamination of mission-essential portions of one’s equipment before continuing the mission. Operator’s spraydown is most effective when done within 15 minutes of contamination. Those surfaces that must be touched on the exterior of the vehicle or equipment that must be used are decontaminated with onboard portable decontamination apparatus (such as the M-11 or M-13). (FM 3-5)

opposed entry – A military operation to enter an area against opposition. See also **air assault operation; airborne operation; amphibious operation; assault echelon**. (FM 90-26)

opposing information – Intentional or unintentional truth-based information from any source that represents an opposing view. (FM 3-13)

order – (DOD, NATO) A communication, written, oral, or by signal, which conveys instructions from a superior to a subordinate. [Note: the NATO definition ends here.] In a broad sense, the terms “order” and “command” are synonymous. However, an order implies discretion as to the details of execution whereas a command does not. See also **fragmentary order; movement order; operation order; overlay order; warning order**. (FM 6-0)

orders group – A group assembled to receive a commander’s orders. The basic composition of this group is normally prescribed in the standing operating procedures of the unit or formation concerned. (FM 101-5)

organic – (DOD) Assigned to and forming an essential part of a military organization. Organic parts of a unit are those listed in its table of organization for the Army, Air Force, and Marine Corps, and are assigned to the administrative organizations of the operating forces for the Navy. See also **assign; attach; operational control**. See FM 6-0.

organophosphate – A phosphate-containing organic compound. Organophosphates inhibit cholinesterase enzymes. G-series and H-series nerve agents are organophosphates, as are certain common insecticides. (FM 3-9)

out – A procedure word meaning, “This is the end of my transmission to you and no answer is required or expected.” (Since “over” and “out” have opposite meanings, they are never used together.) See also **procedure word**. (FM 24-19)

over – (NATO) In artillery and naval fire support, a spotting or an observation, used by a spotter or an observer, to indicate that a burst(s) occurred beyond the target in relation to the spotting line. [Note: the Army definition also applies to mortar fire]. See FM 6-30. (Army) 1. A procedure word meaning, “This is the end of my transmission to you and a response is necessary. Go ahead; transmit.” See also **procedure word**. (FM 24-19) 2. In direct fire, a sensing that a round or burst of rounds went above the intended target and landed beyond the target. (FM 3-20.12)

overlap tell – (NATO) The transfer of information to an adjacent facility concerning tracks detected in the adjacent facility’s area of concern. See also **track telling**.

overlay – (DOD) A printing or drawing on a transparent or semi-transparent medium at the same scale as a map, chart, etc., to show details not appearing or requiring special emphasis on the original. (Army) On digital displays, a set of graphical data that can be placed or removed from another set of graphical data without causing distortion of or damage to either set of graphical data. (FM 101-5)

overlay order – A technique used to issue an order (normally a fragmentary order) that has abbreviated instructions written on an overlay. (FM 101-5)

overt operation – (DOD) An operation conducted openly, without concealment. See also **clandestine operation; covert operation**. See FM 100-25.

overwatch – (Army/Marine Corps) 1. A tactical movement technique in which one element is positioned to support the movement of another element with immediate fire. 2. The tactical role of an element positioned to support the movement of another element with immediate fire. See also **support by fire**. See FM 3-90.

—P—

packaged petroleum product – (DOD) A petroleum product (generally a lubricant, oil, grease, or specialty item) normally packaged by a manufacturer and procured, stored, transported, and issued in containers having a fill capacity of 55 United States gallons (or 45 Imperial gallons, or 205 liters) or less. See FM 10-67.

palletized unit load – (DOD, NATO) Quantity of any item, packaged or unpackaged, which is arranged on a pallet in a specified manner and securely strapped or fastened thereto so that the whole is handled as a unit. See FM 10-1.

parallel planning – (Army) Two or more echelons planning for an operation nearly simultaneously. (FM 101-5) (Marine Corps) Planning by parallel chains of command refers to the planning procedures resulting from the close and continuous coordination necessary between corresponding naval and troop echelons.

paramilitary forces – (DOD) Forces or groups distinct from the regular armed forces of any country, but resembling them in organization, equipment, training, or mission. See FM 3-07.

partial mobilization – (DOD) Expansion of the active Armed Forces resulting from action by Congress (up to full mobilization) or by the President (not more than 1,000,000 for more than 24 consecutive months) to mobilize Ready Reserve Component units, individual reservists, and the resources needed for their support to meet the requirements of a war or other national emergency involving an external threat to the national security. See also **mobilization**. See FM 100-17.

passage lane – A lane through an enemy or friendly obstacle that provides a safe passage for a passing force. (FM 3-90)

passage of lines – (DOD, NATO) An operation in which a force moves forward or rearward through another force's combat positions with the intention of moving into or out of contact with the enemy. A passage may be designated as a forward or rearward passage of lines. [Note: the NATO definition does not include the last sentence.] (Army) A tactical enabling operation in which one unit moves through another unit's positions with the intent of moving into or out of enemy contact. (FM 3-90). (See page A-4 for symbols.)

passage point – A specifically designated place where the passing units will pass through the stationary unit. Also called **PP**. (FM 3-90) (See page 7-43 for symbol.)

passive air defense – (DOD) All measures, other than active air defense, taken to minimize the effectiveness of hostile air and missile threats against friendly forces and assets. These measures include camouflage, concealment, deception, dispersion, reconstitution, redundancy, detection and warning systems, and the use of protective construction. (NATO) All measures, other than active air defense, taken to minimize the effectiveness of hostile air action. These measures include deception, dispersion, and the use of protective construction. See also **active air defense**; **air defense**; **concealment**; **deception**; **dispersion**. See FM 44-100.

passive defense – (DOD) Measures taken to reduce the probability of and to minimize the effects of damage caused by hostile action without the intention of taking the initiative. (Army) One of the four operational elements of theater missile defense. Operations that provide essential individual and collective protection for friendly forces, population centers, and critical assets. The principal measures used to accomplish passive defense are tactical warning, reducing target effectiveness, reducing vulnerability, and recovery and reconstitution. See also **active defense**; **attack operations**; **theater missile defense**. (FM 100-12)

passive defense measures – Measures taken to reduce the possibilities or effects of nuclear, biological, and chemical attack. (FM 3-3)

passive mine – (DOD) 1. A mine whose anticountermining device has been operated preventing the firing mechanism from being actuated. The mine will usually remain passive for a comparatively short time. 2. A mine which does not emit a signal to detect the presence of a target. See FM 20-32.

pass time – (DOD) In road transport, the time that elapses between the moment when the leading vehicle of a column passes a given point and the moment when the last vehicle passes the same point. See FM 55-1.

password – (DOD, NATO) A secret word or distinctive sound used to reply to a challenge. See also **challenge**. See FM 11-43.

pathfinders – (DOD) 1. Experienced aircraft crews who lead a formation to the drop zone, release point, or target. See FM 90-26. 2. Teams dropped or air landed at an objective to establish and operate navigational aids for the purpose of guiding aircraft to drop and landing zones. See FM 90-26. 3. A radar device used for navigating or homing to an objective when visibility precludes accurate visual navigation. 4. Teams air delivered into enemy territory for the purpose of determining the best approach and withdrawal lanes, landing zones, and sites for helicopterborne forces. See FM 90-26. See also **landing zone control party**.

patient decontamination – The process of decontaminating patients using nonmedical personnel as patient decontamination teams working under the supervision of medical personnel. The patient decontamination process is performed at a location adjacent to the supporting medical treatment facility. See also **patient decontamination team**. (FM 4-02.7)

patient decontamination team – A team composed of nonmedical personnel designated by the supported unit commander to perform patient decontamination under medical supervision. See also **patient decontamination**. (FM 4-02.7)

patrol – (DOD, NATO) A detachment of ground, sea, or air forces sent out for the purpose of gathering information or carrying out a destructive, harassing, mopping-up, or security mission. See FM 7-7.

patrol base – The point of origin of a patrol where all equipment not required for the patrol is left. All supplies necessary for resupplying the patrol and additional medical supplies and assistance are staged at this location. (FM 7-7)

pattern laying – (DOD, NATO) In land mine warfare, the laying of mines in a fixed relationship to each other. See FM 20-32.

payload – (DOD, NATO) 1. The sum of the weight of passengers and cargo that an aircraft can carry. See FM 55-17. 2. The warhead, its container, and activating devices in a military missile. See FM 44-100. 3. The satellite or research vehicle of a space probe or research missile. 4. The load (expressed in tons of cargo or equipment, gallons of liquid, or number of passengers) which the vehicle is designed to transport under specified conditions of operation, in addition to its unladen weight. See FM 55-17.

peace building – (DOD) Post-conflict actions, predominantly diplomatic and economic, that strengthen and rebuild governmental infrastructure and institutions in order to avoid a relapse into conflict. See also **peace enforcement**; **peacekeeping**; **peacemaking**; **peace operations**. See FM 3-07.

peace enforcement – (DOD) Application of military force, or the threat of its use, normally pursuant to international authorization, to compel compliance with resolutions or sanctions designed to maintain or restore peace and order. Also called **PE**. See also **peace building**; **peacekeeping**; **peacemaking**; **peace operations**. See FM 3-07.

peacekeeping – (DOD) Military operations undertaken with the consent of all major parties to a dispute, designed to monitor and facilitate implementation of an agreement (ceasefire, truce, or other such agreement) and support diplomatic efforts to reach a long-term political settlement. See also **peace building**; **peace enforcement**; **peacemaking**; **peace operations**. See FM 3-07.

peacemaking – (DOD) The process of diplomacy, mediation, negotiation, or other forms of peaceful settlements that arranges an end to a dispute and resolves issues that led to it. See also **peace building**; **peace enforcement**; **peacekeeping**; **peace operations**. See FM 3-07.

peace operations – (DOD) A broad term that encompasses peacekeeping operations and peace enforcement operations conducted in support of diplomatic efforts to establish and maintain peace. Also called **PO**. See also **peace building**; **peace enforcement**; **peacekeeping**; **peacemaking**. See FM 3-07.

peace support psychological activities – Planned psychological activities conducted as an integral part of peace support operations, designed to create a supportive atmosphere and a willingness to cooperate among the parties in conflict and civilian population in the area of operations, to protect the force and assist in the achievement of mission objectives. Also called **PSPA**. (FM 3-05.30)

peacetime military engagement – All military activities that involve other nations and are intended to shape the security environment in peacetime. It includes programs and exercises that the US military conducts with other nations to shape the international environment, improve mutual understanding with other countries, and improve interoperability with treaty partners or potential coalition partners. Peacetime military engagement activities are designed to support a combatant commander's objectives as articulated in the theater engagement plan. Also called **PME**. (FM 3-0)

penetration – (DOD, NATO) In land operations, a form of offensive which seeks to break through the enemy's defense and disrupt the defensive system. (Army) A form of maneuver in which an attacking force seeks to rupture enemy defenses on a narrow front to disrupt the defensive system. (FM 3-90). (See page A-5 for symbol.)

perceptions – Mental images the commander wants the deception target to believe are real. See also **deception target**. (FM 3-13)

perimeter defense – (DOD) A defense without an exposed flank, consisting of forces deployed along the perimeter of the defended area. See also **strong point**. See FM 3-90.

periodic monitoring – The periodic check of the unit area for presence of beta or gamma radiation. It is performed when intelligence indicates threat use of nuclear weapons, nuclear warfare has been initiated, the dose rate falls below 1 centigray per hour, or when ordered by the unit commander. (FM 3-3-1)

permissive environment – (DOD) Operational environment in which host country military and law enforcement agencies have control as well as the intent and capability to assist operations that a unit intends to conduct. See also **operational environment**. See FM 3-07.

persistence – (DOD, NATO) In biological or chemical warfare, the characteristic of an agent which applies to the duration of its effectiveness under determined conditions after its dispersal. See FM 3-9.

persistent agent – (DOD) A chemical agent that, when released, remains able to cause casualties for more than 24 hours to several days or weeks. See FM 3-9.

personal wipedown – Process of removing or neutralizing contamination from the individual's equipment including the protective mask, hood, gloves, weapon, and helmet. It is performed to stop the spread, transfer, and penetration of contamination. (FM 3-5)

petroleum, oils, and lubricants – (DOD, NATO) A broad term which includes all petroleum and associated products used by the Armed Forces. Also called **POL**. See FM 4-0.

phase – (Army) A specific part of an operation that is different from those that precede or follow. A change in phase usually involves a change of task. (FM 3-0) (Marine Corps) A planning and execution tool that is used to divide an operation in duration or activity. A change in phase may involve a change in task or task organization. Phasing helps in planning and controlling and may be indicated by time, by distance, by terrain, or by occurrence of an event.

phase line – (DOD) A line utilized for control and coordination of military operations, usually an easily identified feature in the operational area. (NATO) A line utilized for control and coordination of military operations, usually a terrain feature extending across the zone of action. Also called **PL**. See FM 3-90. (See page 7-15 for symbol.)

phoney minefield – (DOD, NATO) An area free of live mines used to simulate a minefield or section of a minefield, with the object of deceiving the enemy. See also **gap**; **minefield**. See FM 20-32. See page 7-24 for symbol.

physical destruction – The application of combat power to destroy or degrade adversary forces, sources of information, command and control systems, and installations. It includes direct and indirect forces from ground, sea, and air forces. Also included are direct actions by special operations forces. (FM 3-13)

physical hazards – Those hazards that can cause explosions, fires, violent chemical reactions, and other hazardous situations. (FM 3-100.4)

physical security – (DOD, NATO) That part of security concerned with physical measures designed to safeguard personnel; to prevent unauthorized access to equipment, installations, material, and documents; and to safeguard them against espionage, sabotage, damage, and theft. See also **communications security**; **operations security**. See FM 3-19.30.

pickup zone – A geographic area used to pick up troops or equipment by helicopter. Also called **PZ**. (FM 90-4) (See page 7-17 for symbol.)

pickup zone control officer – The officer designated by the commander with the responsibility for establishing, organizing, setting up, and controlling the pickup zone during air assault pickup zone operations. Also called **PZCO**. (FM 90-4)

pickup zone control party – The personnel designated to assist the pickup zone control officer with the establishment, setting up, and controlling of the pickup zone. (FM 90-4)

piecemeal commitment – 1. The immediate employment of units in combat as they become available instead of waiting for larger aggregations of units to ensure mass. 2. The unsynchronized employment of available forces so that their combat power is not employed effectively. (FM 3-90)

pinpoint – (DOD, NATO) 1. A precisely identified point, especially on the ground, that locates a very small target, a reference point for rendezvous or for other purposes; the coordinates that define this point. 2. (DOD only) The ground position of aircraft determined by direct observation of the ground. See FM 3-04.111.

plan – A design for a future or anticipated operation. (FM 101-5)

planned target(s) – (DOD) Targets that are known to exist in an operational area, and against which effects are scheduled in advance or are on call. Examples range from targets on joint target lists in the applicable campaign plans, to targets detected in sufficient time to list in the air tasking order, mission-type orders, or fire support plan. Planned targets have two subcategories: scheduled or on-call. (NATO) In artillery and naval gunfire support, a target on which fire is prearranged. [Note: the Army definition also applies to mortar fire.] See also **immediate target(s)**; **on-call target**; **priority target**; **scheduled target(s)**. See FM 6-20-30.

planning – The means by which the commander envisions a desired outcome, lays out effective ways of achieving it, and communicates to his subordinates his vision, intent, and decisions, focusing on the results he expects to achieve. (FM 3-0)

planning factor – (DOD, NATO) A multiplier used in planning to estimate the amount and type of effort involved in a contemplated operation. Planning factors are often expressed as rates, ratios, or lengths of time. See FM 101-5.

planning horizons – Points in time the commander uses to focus the organization's planning efforts to shape future events. (FM 101-5)

planning phase – (DOD) In amphibious operations, the phase normally denoted by the period extending from the issuance of the order initiating the amphibious operation up to the embarkation phase. The planning phase may occur during movement or at any other time upon receipt of a new mission or change in the operational situation. See also **amphibious operation**.

point defense – (DOD) The defense or protection of special vital elements and installations, e.g., command and control facilities or air bases. See FM 44-100.

point obstacle – Any obstruction designed or employed to deny ease of movement on a road, lane, or bridge that is normally part of or completes a larger manmade or natural obstacle that has a designed effect on the attacking enemy force. See also **abatis**; **cratering charge**; **log crib**; **log hurdle**; **log posts**; **road block**. (FM 90-7)

point of departure – (Army) The point where the unit crosses the line of departure and begins moving along a direction of attack. (FM 3-90) (Marine Corps) A specific place where a unit will cross the line of departure. Also called **PD**.

point of impact – (NATO) 1. The point on the drop zone where the first parachutist or air dropped cargo item lands or is expected to land. See FM 90-26. 2. The point at which a projectile, bomb, or re-entry vehicle impacts or is expected to impact. Also called **impact point**.

point target – 1. A target of such small dimension that it requires the accurate placement of ordnance in order to neutralize or destroy it. (FM 6-20-40) 2. Nuclear—A target in which the ratio of radius of damage to target radius is equal to or greater than 5. (FM 100-30)

police information – The products from the collection, analysis, and interpretation of all available information concerning known and potential enemy and criminal threats and vulnerabilities of support organizations. It involves intelligence preparation of the battlefield, criminal intelligence preparation of the battlefield, and the police information assessment process. (FM 3-19.1)

police intelligence operations – A military police function that supports, enhances, and contributes to the commander's force protection program, common operational picture, and situational understanding. The police intelligence operations function ensures that information collected during the conduct of other military police functions is provided as input to the intelligence collection effort and turned into action or reports. (FM 7-15)

populace and resource control – Operations in populace and resource control (PRC) provide security for the populace, deny personnel and materiel to the enemy, mobilize population and materiel resources, and detect and reduce the effectiveness of enemy agents. Populace control measures include curfews, movement restrictions, travel permits, registration cards, and resettlement of villagers. Resource control measures include licensing, regulations or guidelines, checkpoints (for example, road blocks), ration controls, amnesty programs, and

inspection of facilities. Most military operations employ some type of PRC measures. Also called **PRC**. (FM 41-10)

pop-up point – The location at which aircraft quickly gain altitude for target acquisition and engagement. Also called **PUP**. See also **target box**. (FM 44-100) (See page 7-22 for symbol.)

port – A place at which ships may discharge or receive their cargoes. It includes any port accessible to ships on the seacoast, navigable rivers, or inland waterways. The term “port” should not be used in conjunction with air facilities, which are designated as aerial ports, airports, etc. (FM 4-01.30)

port of debarkation – (DOD) The geographic point at which cargo or personnel are discharged. This may be a seaport or aerial port of debarkation; for unit requirements, it may or may not coincide with the destination. Also called **POD**. See also **port of embarkation**. See FM 4-01.30.

port of embarkation – (DOD) The geographic point in a routing scheme from which cargo and personnel depart. This may be a seaport or aerial port from which personnel and equipment flow to a port of debarkation; for unit and nonunit requirements, it may or may not coincide with the origin. Also called **POE**. See also **port of debarkation**. See FM 4-01.30.

position – 1. A location or area occupied by a military unit. 2. The location of a weapon, unit, or individual from which fire is delivered upon a target. Positions may be classified as primary, alternate, subsequent, and supplementary positions. See also **alternate position; battle position; primary position; subsequent position; supplementary position**. (FM 3-90)

position area for artillery – An area assigned to an artillery unit where individual artillery systems can maneuver to increase their survivability. A position area for artillery is not an area of operations for the artillery unit occupying it. Also called **PAA**. (FM 3-90) (See page 7-38 for symbol.)

positive control – (DOD) A method of airspace control that relies on positive identification, tracking, and direction of aircraft within an airspace, conducted with electronic means by an agency having the authority and responsibility therein. See FM 3-52. (Army) A technique of regulating forces that involves commanders and leaders actively assessing, deciding, and directing them. (FM 6-0)

post-conflict activity – Those stability operations and support operations that are conducted in the period following conflict termination. (FM 41-10)

power projection – (DOD) The ability of a nation to apply all or some of its elements of national power—political [Note: the Army replaces “political” with “diplomatic.”], economic, informational, or military—to rapidly and effectively deploy and sustain forces in and from multiple dispersed locations to respond to crises, to contribute to deterrence, and to enhance regional stability. See FM 3-0. (Marine Corps) The application of measured, precise offensive military force at a chosen time and place, using maneuver and combined arms against enemy forces.

precedence – (DOD) 1. **communications**—A designation assigned to a message by the originator to indicate to communications personnel the relative order of handling and to the addressee the order in which the message is to be noted. Examples of communications precedence from most immediate to least are flash, immediate, priority, and routine. See FM 24-1. 2. **reconnaissance**—A letter designation, assigned by a unit requesting several

reconnaissance missions, to indicate the relative order of importance (within an established priority) of the mission request. 3. **evacuation**—The assignment of a priority for medical evacuation that is based on a patient condition, advice of the senior medical person at the scene, and the tactical situation. See FM 8-10-6.

preclusion of damage – A nuclear planning restriction used in conjunction with least separation distance to avoid damage to important structures. If appropriate, it is included in the commander's guidance. See also **least separation distance**; **preclusion of obstacles**. (FM 100-30)

preclusion of obstacles – A nuclear planning restriction used in conjunction with least separation distance which, if appropriate, is included in the commander's guidance. It can include preclusion of fallout and tree blowdown. See also **least separation distance**; **preclusion of damage**. (FM 100-30)

preclusion-oriented method analysis – A method of analyzing nuclear targets used when detailed information about size, composition, disposition, location, and movement is not available. (FM 100-30)

preparation – Activities by the unit before execution to improve its ability to conduct the operation, including, but not limited to, the following: plan refinement, rehearsals, reconnaissance, coordination, inspection, and movement. (FM 3-0)

preparation fire – (DOD) Fire delivered on a target preparatory to an assault. (NATO) Fire delivered before an attack to weaken the enemy position. See also **fire**. See FM 6-20-40.

preplanned air support – (DOD, NATO) Air support in accordance with a program, planned in advance of operations. See also **air support**. See FM 3-04.111.

preplanned mission request – (DOD) A request for an air strike on a target that can be anticipated sufficiently in advance to permit detailed mission coordination and planning. See FM 6-20.

pre-position – (DOD, NATO) To place military units, equipment, or supplies at or near the point of planned use or at a designated location to reduce reaction time, and to ensure timely support of a specific force during initial phases of an operation. See FM 100-17-2.

pre-positioned supplies – Supplies located at or near the point of planned use or at other designated locations to reduce reaction time and to ensure resupply. (FM 100-17-2)

prescribed load – The quantity of combat essential supplies and repair parts (other than ammunition) authorized by major commanders to be on hand in units and which is carried by individuals or on unit vehicles. The prescribed load is continuously reconstituted as used. (FM 4-0)

pre-stock point – Location where mines, explosives, and materials for use in preparation of a planned obstacle are stored. (FM 20-32)

preventive maintenance – (DOD) The care and servicing by personnel for the purpose of maintaining equipment and facilities in satisfactory operating condition by providing for systematic inspection, detection, and correction of incipient failures either before they occur or before they develop major defects. Also called **PM**. See also **preventive maintenance checks and services**. See FM 4-30.3.

preventive maintenance checks and services – Operator-level maintenance conducted before, during, and after equipment operations to identify actual and potential problems and to make repairs in a timely manner to minimize equipment downtime. Also called **PMCS**. (FM 4-30.3)

preventive medicine measures – Measures to counter the medical threat and prevent disease and injury. (FM 4-02)

primary position – The position that covers the enemy’s most likely avenue of approach into the area of operations. See also **alternative position; battle position; subsequent position; successive positions; supplementary position**. (FM 3-90)

principles of war – Principles that provide general guidance for conducting war and military operations other than war at the strategic, operational, and tactical levels. The nine principles of war are: **objective**—direct every military operation toward a clearly defined, decisive, and attainable objective; **offensive**—seize, retain, and exploit the initiative; **mass**—concentrate the effects of combat power at the decisive place and time; **economy of force**—allocate minimum essential combat power to secondary efforts; **maneuver**—place the enemy in a disadvantageous position through the flexible application of combat power; **unity of command**—for every objective, ensure unity of effort under one responsible commander; **security**—never permit the enemy to acquire an unexpected advantage; **surprise**—strike the enemy at a time or place or in a manner for which he is unprepared; **simplicity**—prepare clear, uncomplicated plans and clear, concise orders to ensure thorough understanding. (FM 3-0)

priority – A procedure word meaning, “Precedence priority.” Reserved for important messages that must have precedence over routine traffic. This is the highest precedence that normally may be assigned to a message of administrative nature. See also **procedure word**. (FM 24-19)

priority intelligence requirements – (DOD, NATO) Those intelligence requirements for which a commander has an anticipated and stated priority in his task of planning and decisionmaking. See FM 3-0. (Marine Corps) In Marine Corps usage, an intelligence requirement associated with a decision that will critically affect the overall success of the command’s mission. Also called **PIRs**. See also **commander’s critical information requirements; information requirements; intelligence; intelligence cycle**.

priority message – (DOD) A category of precedence reserved for messages that require expeditious action by the addressee(s) and/or furnish essential information for the conduct of operations in progress when routine precedence will not suffice. See also **precedence**. See FM 24-1.

priority of fire(s) – (Army) The organization and employment of fire support means according to the importance of the supported unit’s mission. (FM 6-20) (Marine Corps) Guidance to a fire support planner to organize and employ fire support means in accordance with the relative importance of the maneuver unit’s missions.

priority of support – Priorities set by the commander in his concept of operations and during execution to ensure combat support and combat service support are provided to subordinate elements in accordance with their relative importance to accomplishing the mission. (FM 101-5)

priority target – A target on which the delivery of fires takes precedence over all the fires for the designated firing unit or element. The firing unit or element will prepare, to the extent possible, for the engagement of such targets. A firing unit or element may be assigned only one priority target. The designation may be based on either time or importance. (FM 6-20-40)

prisoner of war – (DOD) A detained person as defined in Articles 4 and 5 of the Geneva Convention Relative to the Treatment of Prisoners of War of August 12, 1949. In particular, one who, while engaged in combat under orders of his or her government, is captured by the armed forces of the enemy. As such, he or she is entitled to the combatant's privilege of immunity from the municipal law of the capturing state for warlike acts which do not amount to breaches of the law of armed conflict. For example, a prisoner of war may be, but is not limited to, any person belonging to one of the following categories who has fallen into the power of the enemy: a member of the armed forces, organized militia, or volunteer corps; a person who accompanies the armed forces without actually being a member thereof; a member of a merchant marine or civilian aircraft crew not qualifying for more favorable treatment; or individuals who, on the approach of the enemy, spontaneously take up arms to resist the invading forces. Also called **POW**; **PW**. See FM 3-19.40.

probability – In risk analysis, the likelihood that an event will occur. There are five degrees of probability: frequent (A), likely (B), occasional (C), seldom (D), and unlikely (E). (FM 100-14)

probable line of deployment – (Army) A phase line that a commander designates as the location where he intends to completely deploy his unit into assault formation before he begins the assault. (FM 3-90) (Marine Corps) An easily recognized line selected on the ground where attacking units deploy in line formation prior to beginning a night attack. Also called **PLD**. (See page 7-31 for symbol.)

procedural control – (DOD) A method of airspace control which relies on a combination of previously agreed and promulgated orders and procedures. See FM 3-52. (Army) A technique of regulating forces that relies on a combination of orders, regulations, policies, doctrine, and tactics, techniques, and procedures. (FM 6-0)

procedures – (Army) Standard and detailed courses of action that describe how to perform a task. (FM 3-90) (Marine Corps) The particular courses or modes of action for performing certain functions. See also **tactics, techniques, and procedures**.

procedure word – (DOD) A word or phrase limited to radio telephone procedure used to facilitate communication by conveying information in a condensed standard form. Also called **proword**. See FM 24-19.

process – An information management activity: to raise the meaning of information from data to knowledge. (FM 6-0)

product program – A sequential, coordinated presentation of a series of products to achieve a specific psychological operations objective. See also **psychological operations program**. (FM 3-05.30)

program of targets – (Army) A number of planned targets of a similar nature. A program of targets identified by a code name may be initiated on call, at a specified time, or when a particular event occurs. Targets are fired in a predetermined sequence. (FM 6-20-40) (Marine Corps) A number of individual targets or groups of targets, or both, planned on targets of similar nature and fired on schedule, listed in an artillery fire plan table.

progress – Explicit or implicit evaluation about the significance to the success of the operation (or major activities) of variances from the plan in criteria of success and the progress of the operation. (FM 6-0)

proliferation (nuclear weapons) – (DOD) The process by which one nation after another comes into possession of, or into the right to determine the use of, nuclear weapons; each nation potentially becomes able to launch a nuclear attack upon another nation. See FM 100-30.

propaganda – (DOD, NATO) Any form of communication in support of national objectives designed to influence the opinions, emotions, attitudes, or behavior of any group in order to benefit the sponsor, either directly or indirectly. See also **black propaganda**; **grey propaganda**; **white propaganda**. See FM 3-05.30.

prophylaxis – The use of material to prevent the development of an infection/disease, such as administration of antibiotics pre-exposure or immediately post-exposure to a disease, causing the organism to prevent the development of the disease. (FM 8-284)

protecting smoke – Smoke produced to defeat or degrade target acquisition, guidance systems, or directed-energy weapons. It includes the smoke blanket and smoke curtain. (FM 3-50)

protection – (DOD) 1. Measures that are taken to keep nuclear, biological, and chemical hazards from having an adverse effect on personnel, equipment, or critical assets and facilities. Protection consists of five groups of activities: hardening of positions; protecting personnel; assuming mission-oriented protective posture; using physical defense measures; and reacting to attack. 2. In space usage, active and passive defensive measures to ensure that United States and friendly space systems perform as designed by seeking to overcome an adversary's attempts to negate them and to minimize damage if negation is attempted. See also **mission-oriented protective posture**. (Army) The preservation of the fighting potential of a force so the commander can apply maximum force at the decisive time and place. (FM 3-0)

protective minefield – (DOD, NATO) 1. In land mine warfare, a minefield employed to assist a unit in its local, close-in protection. See FM 20-32. 2. In naval mine warfare, a minefield laid in friendly territorial waters to protect ports, harbors, anchorages, coasts, and coastal routes. See also **minefield**.

protective obstacles – Obstacles employed to assist a unit in its local, close-in protection. (FM 90-7)

psychological consolidation activities – (DOD) Planned psychological activities across the range of military operations directed at the civilian population located in areas under friendly control in order to achieve a desired behavior that supports the military objectives and the operational freedom of the supported commanders. Also called **PCA**. See FM 3-05.30.

psychological media – (NATO) The media—technical or non-technical—which establish any kind of communication with a target audience. See FM 3-05.30.

psychological operations – (DOD) Planned operations to convey selected information and indicators to foreign audiences to influence their emotions, motives, objective reasoning, and ultimately the behavior of foreign governments, organizations, groups, and individuals. The purpose of psychological operations is to induce or reinforce foreign attitudes and behavior

favorable to the originator's objectives. Also called **PSYOP**. See FM 3-05.30. (See page 5-31 for symbol.)

psychological operations action – Action or activity planned primarily for its psychological impact. Also called **PSYOPACT**. (FM 3-05.30)

psychological operations approach – The technique adopted to induce a desired reaction on the part of the target audience. Also called **PSYOP approach**. (FM 3-05.30)

psychological operations development center – A regional psychological operations unit that designs informational products and programs and makes recommendations to the joint force commander through the joint targeting coordination board for other joint forces to conduct psychological actions in support of military and national objectives. The psychological operations development center is the central core of a psychological operations task force. It consists of a target audience analysis detachment, a plans and programs detachment, and a test and evaluation detachment. Also called **PDC**. (FM 3-05.30)

psychological operations enabling actions – Action required of non-psychological operations units or non-Department of Defense (DOD) agencies in order to facilitate or enable execution of a psychological operations plan developed to support a command, joint task force, a combatant commander, or other non-DOD agency. Also called **PSYOP enabling actions**. (FM 3-05.30)

psychological operations situation – That part of the overall operation situation in which psychological operations taken at the command and unit level, as well as the commitment of psychological operations units, are planned and executed. Also called **PSYOP situation**. (FM 3-05.30)

psychological situation – The current emotional state, mental disposition, or other behavioral motivation of a target audience, basically founded on its national, political, social, economic, and psychological peculiarities, but also subject to the influence of circumstances and events. (FM 3-05.30)

psychological theme – (NATO) An idea or topic on which a psychological operation is based. See FM 3-05.30.

psychological warfare – (DOD) The planned use of propaganda and other psychological actions having the primary purpose of influencing the opinions, emotions, attitudes, and behavior of hostile foreign groups in such a way as to support the achievement of national objectives. Also called **PSYWAR**. See FM 3-05.30.

public affairs – (DOD) Those public information, command information, and community relations activities directed toward both the external and internal publics with interest in the Department of Defense. Also called **PA**. See FM 46-1. (See page 5-21 for symbol.)

pursuit – (DOD, NATO) An offensive operation designed to catch or cut off a hostile force attempting to escape, with the aim of destroying it. See also **offensive operations**. See FM 3-0.

push – 1. In intelligence and communications, the broadcasting of information to multiple stations simultaneously without the need for them to request or interrogate the host system. (FM 11-32) 2. In logistics, the delivery of a predetermined amount of supplies to a user on a scheduled basis without the user requesting them. (FM 4-0)

pyrotechnic – (DOD) A mixture of chemicals which, when ignited, is capable of reacting exothermically to produce light, heat, smoke, sound, or gas. [Note: the Army definition adds, “...and may also be used to introduce a delay into an explosive train because of its known burning time. The term excludes propellants and explosives.”] See FM 5-250.

—Q—

quadrant elevation – (DOD, NATO) The angle between the horizontal plane and the axis of the bore when the weapon is laid. It is the algebraic sum of the elevation, angle of site, and complementary angle of site. [Note: the NATO definition does not include the last sentence.] See FM 6-20-40.

quartering party – A group of unit representatives dispatched to a probable new site of operations in advance of the main body to secure, reconnoiter, and organize an area prior to the main body’s arrival and occupation. See also **advance party**. (FM 3-90)

quay – (DOD) A structure of solid construction along a shore or bank that provides berthing and generally provides cargo-handling facilities. A similar facility of open construction is called a wharf. See FM 4-01.30.

—R—

rad – See **centigray**.

radar beacon – (DOD) A receiver-transmitter combination that sends out a coded signal when triggered by the proper type of pulse, enabling determination of range and bearing information by the interrogating station or aircraft. Also called **RB**. See FM 11-32.

radiac – (NATO) An acronym derived from the words “radioactivity, detection, indication, and computation” and used as an all-encompassing term to designate various types of radiological measuring instruments and equipment. (This word is normally used as an adjective.) See FM 3-11.4.

radiation dose – (DOD, NATO) The total amount of ionizing radiation absorbed by material or tissues, expressed in centigrays. [Note: the NATO definition ends here.] The term radiation dose is often used in the sense of the exposure dose expressed in roentgens, which is a measure of the total amount of ionization that the quantity of radiation could produce in air. This could be distinguished from the absorbed dose also given in rads, which represents the energy absorbed from the radiation per gram of specified body tissue. Further, the biological dose, in rems, is a measure of the biological effectiveness on the radiation exposure. See also **absorbed dose**; **centigray**; **exposure dose**; **radiation dose rate**. See FM 3-11.4.

radiation dose rate – (DOD, NATO) The radiation dose (dosage) absorbed per unit of time. [Note: the NATO definition ends here.] A radiation dose rate can be set at some particular unit of time (e.g., H+1 hour) and would be called H+1 radiation dose rate. See also **radiation dose**. See FM 3-3-1.

radiation exposure state – (DOD, NATO) The condition of a unit, or exceptionally an individual, deduced from the cumulative whole body radiation dose(s) received. It is expressed as a symbol which indicates the potential for future operations and the degree of risk if exposed to additional nuclear radiation. Also called **RES**. See FM 3-11.4.

radiation status – Criteria to assist the commander in measuring unit exposure to radiation based on total past cumulative dose in centigray (cGy). Categories are as follows:

a. **radiation exposure status-0 (RES-0)**—No previous exposure history. b. **radiation exposure status-1 (RES-1)**—Negligible radiation exposure history (greater than 0 but less than 70 cGy). c. **radiation exposure status-2 (RES-2)**—Significant but not a dangerous dose of radiation (greater than 70, but less than 150 cGy). d. **radiation exposure status-3 (RES-3)**—Unit has already received a dose of radiation which makes further exposure dangerous (greater than 150 cGy). Also called **RS**. See also **dose rate; operation exposure guide; radiation dose**. (FM 3-3-1)

radio fix – (DOD, NATO) The location of a ship or aircraft by determining the direction of radio signals coming to the ship or aircraft from two or more sending stations, the locations of two which are known. (NATO only) The locating of a radio transmitter by bearings taken from two or more direction finding stations, the site of the transmitter being at the point of intersection. See FM 11-32.

radio listening silence – The situation where radios are on and continuously monitored with strict criteria when a station on the radio network is allowed to break silence. For example, “maintain radio listening silence until physical contact with the enemy is made.” See also **radio silence**. (FM 24-1)

radiological monitoring – See **monitoring**.

radiological survey – (DOD, NATO) The directed effort to determine the distribution and dose rates of radiation in the area. See also **nuclear, biological, and chemical survey**. See FM 3-19.

radio silence – (DOD, NATO) A condition in which all or certain radio equipment capable of radiation is kept inoperative. [Note: the NATO definition ends here.] (Note: In combined or United States joint or intra-Service communications the frequency bands and/or types of equipment affected will be specified.) See FM 24-1.

radius of action – (DOD, NATO) The maximum distance a ship, aircraft, or vehicle can travel away from its base along a given course with normal combat load and return without refueling, allowing for all safety and operating factors. See FM 55-1.

radius of damage – (DOD) The distance from ground zero at which there is a 0.50 probability of achieving the desired damage. Also called **RD**. See also **collateral damage**. See FM 100-30.

radius of vulnerability (nuclear) – The radius of a circle about ground zero within which friendly personnel will be exposed to a risk equal to, or greater than, the emergency risk criterion, or within which materiel will be subjected to a 5-percent probability of the specified degree of damage. Also called **RV**. (FM 100-30)

raid – (DOD, NATO) An operation, usually small scale, involving a swift penetration of hostile territory to secure information, confuse the enemy, or to destroy installations. It ends with a planned withdrawal upon completion of the assigned mission. See FM 3-0.

railhead – (DOD, NATO) A point on a railway where loads are transferred between trains and other means of transport. See also **aerial port; seaport**. See FM 55-20. (See page 5-24 for symbol.)

rally point – 1. An easily identifiable point on the ground at which units can reassemble and reorganize if they become dispersed. (FM 3-90) 2. An easily identifiable point on the ground

at which aircrews and passengers can assemble and reorganize following an incident requiring a forced landing. Also called **RP**. (FM 3-90) (See page 7-43 for symbol.)

random minelaying – (DOD) In land mine warfare, the laying of mines without regard to pattern. See FM 20-32.

range – (DOD) 1. The distance between any given point and an object or target. See FM 6-30. 2. Extent or distance limiting the operation or action of something, such as the range of an aircraft, ship, or gun. See FM 6-30. 3. The distance that can be covered over a hard surface by a ground vehicle, with its rated payload, using the fuel in its tank, and its cans normally carried as part of the ground vehicle equipment. See FM 55-17. 4. Area equipped for practice in shooting at targets. In this meaning, also called **target range**. See FM 6-30.

range probable error – The range error caused by dispersion that will be exceeded as often as not in an infinite number of rounds fired at the same elevation and is one-eighth of the length of the dispersion pattern at its greatest length. The value is given in the firing tables. (FM 6-20-40)

range spread – (DOD) The technique used to place the mean point of impact of two or more units 100 meters apart on the gun-target line. See FM 6-20-40.

rapport – In intelligence usage, a condition established by a human intelligence (HUMINT) collector that is characterized by source confidence in the HUMINT collector and a willingness to cooperate with him. (FM 34-52)

rate of fire – (DOD, NATO) The number of rounds fired per weapon per minute. See FM 3-21.91.

R-day – (DOD) Redeployment day. The day on which redeployment of major combat, combat support, and combat service support forces begins in an operation. See also **times**. See FM 101-5.

reachback – (DOD) The process of obtaining products, services, and applications, or forces, or equipment, or material from organizations that are not forward deployed. (Army/Marine Corps) The ability to exploit resources, capabilities, expertise, etc., not physically located in the theater or a joint operations area, when established.

reactivity – One of the four possible characteristics of hazardous waste. It is the ability to enter into a violent chemical reaction, which may involve explosions or fumes. See also **hazardous waste**. (FM 3-100.4)

read back – A procedure word meaning, “Repeat this entire transmission back to me exactly as received.” See also **procedure word**. (FM 24-19)

real time – (DOD) Pertaining to the timeliness of data or information which has been delayed only by the time required for electronic communication. This implies that there are no noticeable delays. See also **near real time**. See FM 3-13.

rear area – (DOD) For any particular command, the area extending forward from its rear boundary to the rear of the area assigned to the next lower level of command. This area is provided primarily for the performance of support functions. [Note: the Army definition adds, “... and is where the majority of the echelon’s sustaining functions occur.”] See also **brigade support area**; **division support area**. See FM 3-0.

rear area operations center/rear tactical operations center – (DOD) A command and control facility that serves as an area and/or subarea commander’s planning, coordinating, monitoring, advising, and directing agency for area security operations. Also called **RAOC**. See FM 3-90

rear area response forces – Forces responsible for rear area threats beyond the capability of base defenses. See also **security operations**. (FM 3-90)

rear area threat levels – Levels of response to threat activities. a. **Level I**—Threats that can be defeated by base or base cluster self-defense measures. b. **Level II**—Threats that are beyond base or base cluster self-defense capabilities but can be defeated by response forces, normally military police, with supporting fires. c. **Level III**—Threats that necessitate the command decision to commit a combined arms tactical combat force to defeat them. (FM 3-90)

rear boundary – Line that defines the rear area of operations assigned to a particular unit. The area behind the rear boundary belongs to the next higher commander and positioning of elements behind it must be coordinated with that commander. See also **boundary**. (FM 3-90) (See page 7-13 for symbol.)

rear command post – The rear echelon of a unit’s headquarters, consisting of those staff activities concerned primarily with combat service support of the force, administrative support of the headquarters, and other activities not immediately concerned with decisive operations or operations within the close area. Typical representatives within the rear echelon are elements of the G-1 and G-4 sections, G-5, adjutant general, staff judge advocate, inspector general, surgeon, provost marshal, supporting military intelligence elements concerned with counterintelligence and prisoner of war interrogation activities, and the tactical airlift representative of the tactical air control party. See also **command post**. (See page 5-39 for symbol.)

rear guard – (DOD) 1. The rearmost elements of an advancing or a withdrawing force. It has the following functions: to protect the rear of a column from hostile forces; during the withdrawal, to delay the enemy; during the advance, to keep supply routes open. 2. Security detachment that a moving ground force details to the rear to keep it informed and covered. See also **guard**; **security operations**. See FM 3-90.

rearming – (DOD) 1. An operation that replenishes the prescribed stores of ammunition, bombs, and other armament items for an aircraft, naval ship, tank, or armored vehicle (including replacement of defective ordnance equipment) in order to make it ready for combat service. 2. Resetting the fuze on a bomb, or on an artillery, mortar, or rocket projectile, so that it will detonate at the desired time. See FM 5-100.

rearm, refuel, and resupply point – A designated point through which a unit passes where it receives fuel, ammunition, and other necessary supplies to continue operations. Also called **R³P**. (FM 6-20-30) (See page 7-64 for symbol.)

rearward passage of lines – When a unit passes through another unit’s position while moving away from the enemy. (FM 3-90)

rebuild – (DOD) The restoration of an item to a standard as nearly as possible to its original condition in appearance, performance, and life expectancy. See FM 4-0.

reception – (DOD) 1. All ground arrangements connected with the delivery and disposition of air or sea drops. Includes selection and preparation of site, signals for warning and approach, facilitation of secure departure of agents, speedy collection of delivered articles, and their prompt removal to storage places having maximum security. When a group is involved, it may be called a reception committee. See FM 100-17-3. 2. Arrangements to welcome and provide secure quarters or transportation for defectors, escapees, evaders, or incoming agents. 3. The process of receiving, offloading, marshalling, and transporting of personnel, equipment, and materiel from the strategic and/or intratheater deployment phase to a sea, air, or surface transportation point of debarkation to the marshalling area. See FM 100-17-3.

receptivity – (NATO) The vulnerability of a target audience to particular psychological operations media. See FM 3-05.30.

reclamation – Regeneration or processing of a material to recover a usable product. Examples include the recovery of lead from spent batteries and the regeneration of spent solvents. (FM 3-100.4)

reconnaissance – (DOD, NATO) A mission undertaken to obtain, by visual observation or other detection methods, information about the activities and resources of an enemy or potential enemy, or to secure data concerning the meteorological, hydrographic, or geographic characteristics of a particular area. Also called **recce**; **recon**. See FM 3-0. (See page 5-13 for symbol.)

reconnaissance by fire – (DOD, NATO) A method of reconnaissance in which fire is placed on a suspected enemy position to cause the enemy to disclose a presence by movement or return of fire. See FM 3-90.

reconnaissance handover – The action that occurs between two elements in order to coordinate the transfer of information and/or responsibility for observation of potential threat contact, or the transfer of an assigned area from one element to another. (FM 3-20.96)

reconnaissance handover line – A designated phase line on the ground where reconnaissance responsibility transitions from one element to another. (FM 3-20.96)

reconnaissance in force – (DOD, NATO) An offensive operation designed to discover and/or test the enemy's strength or to obtain other information. (Army) A deliberate combat operation designed to discover or test the enemy's strength, dispositions, and reactions or to obtain other information. (FM 3-90)

reconnaissance pull – Reconnaissance that determines which routes are suitable for maneuver, where the enemy is strong and weak, and where gaps exist, thus pulling the main body toward and along the path of least resistance. This facilitates the commander's initiative and agility. (FM 3-20.96)

reconnaissance push – Reconnaissance that refines the common operational picture, enabling the commander to finalize the plan and support shaping and decisive operations. It is normally used once the commander is committed to a scheme of maneuver or course of action. (FM 3-20.96)

reconstitution – Extraordinary actions that commanders plan and implement to restore units to a desired level of combat effectiveness commensurate with mission requirements and available resources. (FM 100-9)

- reconstitution site** – (DOD) A location selected by the surviving command authority as the site at which a damaged or destroyed headquarters can be reformed from survivors of the attack and/or personnel from other sources, predesignated as replacements. [Note: the Army term is “regeneration site.”] See FM 100-9.
- record as target** – (NATO) In artillery and naval fire support, the order used to denote that the target is to be recorded for future engagement or reference. [Note: the Army definition also applies to mortar fire.] See FM 6-30.
- recorded** – (NATO) In artillery and naval fire support, the response used to indicate that the action to “record to target” has been completed. See FM 6-30.
- recovered materials** – Waste materials and by-products that have been recovered or diverted from solid waste; does not include those materials and by-products generated from, and commonly reused within, an original manufacturing process. (FM 3-100.4)
- recovery site** – (DOD) In evasion and escape usage, an area from which an evader or an escapee can be evacuated. See also **evasion and escape**. See FM 3-04.111.
- redeployment** – (DOD) The transfer of forces and materiel to support another joint force commander’s operational requirements, or to return personnel, equipment, and materiel to the home and/or demobilization stations for reintegrating and/or out-processing. See FM 100-17.
- reduce** – 1. A tactical mission task that involves the destruction of an encircled or bypassed enemy force. (FM 3-90) 2. One of the five breaching fundamentals. The creation of a lane through, over, or around an obstacle. In the case of minefields, refers to destroying, neutralizing, removing, or bypassing mines. (FM 3-34.2) See also **assault**; **obscure**; **secure**; **suppress**.
- reference box** – (NATO) The identification box placed in the margin of a map or chart which contains the series designation, sheet number and edition number in a readily identifiable form. See FM 3-25.26.
- refuel on the move point** – An area established to ensure that fuel tanks on combat and fuel-servicing vehicles are full before they arrive in the unit’s tactical assembly area. Also called **ROM point**. (FM 71-123) (See page 7-64 for symbol.)
- refugee** – (DOD) A person who, by reason of real or imagined danger, has left their home country or country of their nationality and is unwilling or unable to return. See also **dislocated civilian**; **displaced person**. See FM 3-07. (See page 9-11 for symbol.)
- regeneration** – Rebuilding of a unit through large-scale replacement of personnel, equipment, and supplies, including the reestablishment or replacement of essential command and control and the conduct of mission essential training for the newly rebuilt unit. (FM 100-9)
- regeneration site** – See **reconstitution site**.
- regimental landing team** – (DOD) A task organization for landing comprised of an infantry regiment reinforced by those elements that are required for initiation of its combat function ashore.
- registration fire** – (DOD, NATO) Fire delivered to obtain accurate data for subsequent effective engagement of targets. See also **fire**. See FM 6-20-40.

registration point – (DOD, NATO) Terrain feature or other designated point on which fire is adjusted for the purpose of obtaining corrections to firing data. See FM 6-20-40.

regulated item – (DOD, NATO) Any item whose issuance to a user is subject to control by an appropriate authority for reasons that may include cost, scarcity, technical or hazardous nature, or operational significance. Also called **controlled item**. See FM 4-0.

rehearsal – A session in which a staff or unit practices expected actions to improve performance in execution. (FM 6-0)

rehearsal phase – (DOD) In amphibious operations, the period during which the prospective operation is practiced for the purpose of: (1) testing adequacy of plans, the timing of detailed operations, and the combat readiness of participating forces; (2) ensuring that all echelons are familiar with the plans; and (3) testing communications information systems. See also **amphibious operation**.

reinforcing – (DOD) A support mission in which the supporting unit assists the supported unit's mission. Only like units (e.g., artillery to artillery, intelligence to intelligence, armor to armor, etc.) can be given a reinforcing/reinforced mission. [Note: the Army designates this as a support relationship.] See FM 101-5. (NATO) In artillery usage, tactical mission in which one artillery unit augments the fire of another artillery unit. See FM 6-20. See also **direct support**; **general support-reinforcing**.

reinforcing obstacles – (DOD) Those obstacles specifically constructed, emplaced, or detonated through military effort and designed to strengthen existing terrain to disrupt, fix, turn, or block enemy movement. See also **obstacle**. See FM 90-7.

relateral tell – (DOD, NATO) The relay of information between facilities through a third facility. This type of telling is appropriate between automated facilities in a degraded communication environment. See also **track telling**.

relay to – A procedure word meaning, "Transmit this message to all addressees (or addressees immediately following this proword)." The address component is mandatory when this proword is used. See also **procedure word**. (FM 24-19)

release line – Phase line used in river crossing operations that delineates a change in the headquarters controlling movement. Also called **RL**. (FM 90-13) (See page 7-34 for symbol.)

release point (road) – (DOD) A well-defined point on a route at which the elements composing a column return under the authority of their respective commanders, each one of these elements continuing its movement toward its own appropriate destination. (Army) A location on a route where marching elements are released from centralized control. Also called **RP**. See also **lane**; **march column**; **march serial**; **march unit**; **route**; **start point**. (FM 3-90) (See page 7-43 for symbol.)

relevant information – All information of importance to commanders and staffs in the exercise of command and control. (FM 3-0)

relief in place – (DOD, NATO) An operation in which, by direction of higher authority, all or part of a unit is replaced in an area by the incoming unit. The responsibilities of the replaced elements for the mission and the assigned zone of operations are transferred to the incoming unit. The incoming unit continues the operation as ordered. Also called **RIP**. See FM 3-90. (See page A-5 for symbol.)

religious ministry support – (DOD) The entire spectrum of professional duties to include providing for or facilitating essential religious needs and practices; pastoral care; family support programs; religious education; volunteer and community activities; and programs performed to enhance morale and moral, ethical, and personal well-being. Enlisted religious support personnel assist the chaplain in providing religious ministry support. See FM 1-05.

remote control – In barrier operations, the ability of a user to actuate a charge or change of state of a mine from a distance. For a mine, remote control is divided into: a. **Remote Control Level 1**—Ability to react to a received remote control stimulus to change from standby state to armed. b. **Remote Control Level 2**—As Level 1, and the added ability to react to a received remote control stimulus to return from armed standby state. c. **Remote Interrogation Capability**—The ability of a mine to respond to a remote interrogation on its state, either armed or standby. This capability may be superimposed in either Level 1 or Level 2, and may be indicated by the suffix (I). (FM 20-32)

remote delivery – (DOD) In mine warfare, the delivery of mines to a target area by any means other than direct emplacement. The exact position of mines so laid may not be known. See FM 20-32.

rendezvous – (NATO) 1. A pre-arranged meeting at a given time and location from which to begin an action or phase of an operation or to which to return after an operation. 2. In land warfare, an easily found terrain location at which visitors to units, headquarters, or facilities are met by personnel from the element to be visited.

reorganization – Action taken to shift internal resources within a degraded unit to increase its level of combat effectiveness. (FM 100-9)

repeat – (NATO) In artillery and naval fire support, an order or request to fire again the same number of rounds with the same method of fire. [Note: the Army definition also applies to mortar fire.] See FM 6-30.

required supply rate (ammunition) – (DOD) The amount of ammunition expressed in terms of rounds per weapon per day for ammunition items fired by weapons (and in terms of other units of measure per day for bulk allotment and other items) estimated to be required to sustain operations of any designated force without restriction for a specified period. Tactical commanders use this rate to state their requirements for ammunition to support planned tactical operations at specified intervals. The required supply rate is submitted through command channels. It is consolidated at each echelon and is considered by each commander in subsequently determining the controlled supply rate within the command. Also called **RSR**. See also **controlled supply rate**. See FM 4-0.

requirements management – In intelligence, the development, integration, and management of the intelligence, surveillance, and reconnaissance plan, which sets out how the information needed to meet priority intelligence requirements (PIR) and information requirements is to be collected and how and where it is to be processed into intelligence to answer PIR. (FM 34-2)

reserve – (DOD) 1. Portion of a body of troops which is kept to the rear or withheld from action at the beginning of an engagement, in order to be available for a decisive movement. See FM 3-90. 2. Members of the Military Services who are not in active service but who are subject to call to active duty. 3. Portion of an appropriation or contract authorization held or set aside

for future operations or contingencies and, in respect to which, administrative authorization to incur commitments or obligations has been withheld.

reserved demolition target – (DOD, NATO) A target for demolition, the destruction of which must be controlled at a specific level of command because it plays a vital part in the tactical, operational, [Note: the NATO definition does not include “operational”] or strategic plan, or because of the importance of the structure itself, or because the demolition may be executed in the face of the enemy. See also **demolition target**; **reserved obstacles**. See FM 90-7.

reserved obstacles – (DOD) Those demolition obstacles that are deemed critical to the plan for which the authority to detonate is reserved by the designating commander. (Army) Obstacles of any type, for which the commander restricts execution authority. See also **obstacle**. (FM 90-7)

reserved route – (DOD, NATO) In road traffic, a specific route allocated exclusively to an authority or formation. See also **route**. See FM 4-01.30.

residual radiation – (DOD) Nuclear radiation caused by fallout, artificial dispersion of radioactive material, or irradiation which results from a nuclear explosion and persists longer than one minute after burst. See also **contamination**; **induced radiation**; **initial radiation**. See FM 3-3-1.

residual radioactivity – (DOD) Nuclear radiation that results from radioactive sources and persists for longer than one minute. Sources of residual radioactivity created by nuclear explosions include fission fragments and radioactive matter created primarily by neutron activation, but may also be created by gamma and other radiation activation. Other possible sources of residual radioactivity include radioactive material created and dispersed by means other than nuclear explosion. See also **contamination**; **induced radiation**; **initial nuclear effects**. See FM 3-3-1.

residual risk – The level of risk remaining after controls have been identified and selected for hazards that may result in loss of combat power. Controls are identified and selected until residual risk is at an acceptable level or until it cannot be practically reduced further. (FM 100-14)

response force – (DOD) A mobile force with appropriate fire support designated, usually by the area commander, to deal with Level II threats in the rear area. Also called **RF**.

restoration – The systematic removal of pollution or contaminants from the environment, especially from the soil or ground water, by physical, chemical, or biological means. Also known as **remediation** or **environmental cleanup**. (FM 3-100.4)

restraint – (Marine Corps) Something which is prohibited that limits freedom of action. See also **constraint**.

restricted operations area – (DOD, NATO) Airspace of defined dimensions, designated by the airspace control authority, in response to specific operational situations/requirements within which the operation of one or more airspace users is restricted. Also called **ROA**; **restricted operations zone (ROZ)**. See FM 3-52.

restricted operations zone – See **restricted operations area**. (See page 7-20 for symbol.)

restrictive fire area – (DOD) An area in which specific restrictions are imposed and into which fires that exceed those restrictions will not be delivered without coordination with the establishing headquarters. See FM 6-20-40. (Marine Corps) In Marine Corps usage, the purpose of the restrictive fire area is to regulate fires into an area according to the stated restrictions. Also called **RFA**. See also **fires**. (See page 7-38 for symbol.)

restrictive fire line – (DOD) A line established between converging friendly surface forces that prohibits fires or their effects across that line. See FM 6-20-40. (Marine Corps) In Marine Corps usage, the purpose of the restrictive fire line is to prevent interference between converging friendly forces without coordination with the affected force(s). Also called **RFL**. See also **fires**. (See page 7-36 for symbol.)

resupply – (DOD, NATO) The act of replenishing stocks in order to maintain required levels of supply. See FM 4-0.

retain – (DOD) 1. When used in the context of deliberate planning, the directed command will keep the referenced operation plan, operation plan in concept format, and any associated joint operation planning system of Joint Operation Planning and Execution System automated data processing files in an inactive library status. The plan and its associated files will not be maintained unless directed by follow-on guidance. 2. A tactical task to occupy and hold a terrain feature to ensure that it is free of enemy occupation or use. (Army) A tactical mission task in which the commander ensures that a terrain feature already controlled by a friendly force remains free of enemy occupation or use. (FM 3-90) (See page A-5 for symbol.)

retirement – (DOD, NATO) An operation in which a force out of contact moves away from the enemy. [Note: the Army classifies retirement as “a form of retrograde.”] See FM 3-0. (See page A-5 for symbol.)

retrograde – A type of defensive operation that involves organized movement away from the enemy. (FM 3-0)

reverse slope – Any slope which descends away from the enemy. (FM 3-90)

riot control agent – (DOD) Any chemical that is not listed in the Chemical Weapons Convention which can produce rapidly in humans sensory irritate or disabling physical effects which disappear within a short time following termination of exposure. (NATO) A chemical that is not listed in the schedule of the 1993 Chemical Weapons Convention, which can rapidly produce irritant or disabling physical effects that disappear shortly after termination of exposure. (Army) A substance that produces temporary irritating or disabling physical effects that disappear within minutes of removal from exposure. There is no significant risk of permanent injury, and medical treatment is rarely required. Also called **RCA**. See also **chemical warfare**. (FM 3-11.4)

risk – (DOD) Probability and severity of loss linked to hazards. See also **degree of risk; hazard; risk management**. See FM 100-14.

risk assessment – (DOD) The identification and assessment of hazards (first two steps of risk management process). See FM 100-14.

risk assessment matrix – A tool that can be used to determine levels of risk. Leaders and staffs enter the estimated degree of severity and probability for each identified hazard from

the severity row and probability column respectively. See also **hazard; levels of risk; probability; severity**. (FM 100-14)

risk decision – The decision to accept or not accept the risk(s) associated with an action; made by the commander, leader, or individual responsible for performing that action. (FM 100-14)

risk management – (DOD) The process of identifying, [Note: the Marine Corps definition replaces “identifying” with “detecting”] assessing, and controlling risk arising from operational factors, and making informed decisions that balance risk cost with mission benefits. [Note: the Marine Corps definition adds “The five steps of risk management are identify the hazards, assess the hazards, develop controls and make risk decision, implement controls, and supervise and evaluate.”] See FM 100-14. Also called **RM**. See also **hazard; residual risk; risk; risk assessment; risk decision**.

river crossing – An operation required before ground combat power can be projected and sustained across a water obstacle. It is a centrally planned and controlled offensive operation that requires the allocation of external crossing means and a force dedicated to the security of the bridgehead. See also **deliberate crossing; hasty crossing**. (FM 90-13)

riverine area – (DOD) An inland or coastal area comprising both land and water, characterized by limited land lines of communication, with extensive water surface and/or inland waterways that provide natural routes for surface transportation and communications. See FM 55-50.

riverine operations – (DOD) Operations conducted by forces organized to cope with and exploit the unique characteristics of a riverine area, to locate and destroy hostile forces, and/or to achieve or maintain control of the riverine area. Joint riverine operations combine land, naval, and air operations, as appropriate, and are suited to the nature of the specific riverine area in which operations are to be conducted. See FM 55-50.

road block – (DOD, NATO) A barrier or obstacle (usually covered by fire) used to block or limit the movement of hostile vehicles along a route. See FM 90-7. (See page 7-51 for symbol.)

road clearance time – (DOD, NATO) The total time a column requires to travel over and clear a section of the road. See FM 4-01.30.

roger – A procedure word meaning “I have received your last transmission satisfactorily.” See also **procedure word**. (FM 24-19)

rounds complete – (NATO) In artillery and naval fire support, the procedural term used to indicate that the number of rounds ordered at “fire for effect” have been fired. [Note: the Army definition also applies to mortar fire.] See also **shot**. See FM 6-20-40.

route – (DOD, NATO) The prescribed course to be traveled from a specific point of origin to a specific destination. See also **lateral route; reserved route**. See FM 4-01.30.

route capacity – (DOD, NATO) 1. The maximum traffic flow of vehicles in one direction at the most restricted point on the route. 2. The maximum number of metric tons which can be moved in one direction over a particular route in one hour. It is the product of the maximum traffic flow and the average payload of the vehicles using the route. See FM 4-01.30.

route classification – (DOD, NATO) Classification assigned to a route using factors of minimum width and worst route type, least bridge, raft, or culvert military load

classification, and obstructions to traffic flow. See also **military load classification**. See FM 5-100.

route reconnaissance – (Army/Marine Corps) A directed effort to obtain detailed information of a specified route and all terrain from which the enemy could influence movement along that route. (FM 3-90)

route security operations – A specialized kind of area security operations conducted to protect lines of communication and friendly forces moving along them. (FM 3-90)

routine – A procedure word meaning, “Precedence routine.” Reserved for all types of messages that are not of sufficient urgency to justify a higher precedence, but must be delivered to the addressee without delay. See also **procedure word**. (FM 24-19)

rules of engagement – (DOD) Directives issued by competent military authority that delineate the circumstances and limitations under which United States forces will initiate and/or continue combat engagement with other forces encountered. Also called **ROE**. See also **law of war**. See FM 3-07.

running estimates – A staff estimate, continuously updated, based on new information as the operation proceeds. (FM 6-0)

ruse – (DOD) In military deception, a trick of war designed to deceive the adversary, usually involving the deliberate exposure of false information to the adversary’s intelligence collection system. See also **deception**. See FM 27-10.

—S—

sabotage – (DOD) An act or acts with intent to injure, interfere with, or obstruct the national defense of a country by willfully injuring or destroying, or attempting to injure or destroy, any national defense or war materiel, premises, or utilities, to include human and natural resources. See also **terrorism**. See FM 3-19.1.

safe area – (DOD) A designated area in hostile territory that offers the evader or escapee a reasonable chance of avoiding capture and of surviving until he or she can be evacuated. See FM 100-25.

safe house – (DOD) An innocent-appearing house or premises established by an organization for the purpose of conducting clandestine or covert activity in relative security. See FM 3-05.20. (See page 9-11 for symbol.)

safe state – (NATO) The state in which a mine cannot function and in which it is safe to handle and transport. See FM 20-32.

safety and arming mechanism – (DOD) A dual function device which prevents the unintended activation of a main charge or propulsion unit prior to arming, but allows activation thereafter upon receipt of the appropriate stimuli. See FM 20-32.

safety angle – See **angle of safety**.

salvage – (DOD) 1. Property that has some value in excess of its basic material content but is in such condition that it has no reasonable prospect of use for any purpose as a unit and its repair or rehabilitation for use as a unit is clearly impractical. 2. The saving or rescuing of

condemned, discarded, or abandoned property, and of materials contained therein for reuse, refabrication, or scrapping.

sarin – A g-series nerve agent. Also called **GB**. (FM 3-9)

say again – A procedure word meaning, “Repeat all of your last transmission.” (Followed by identification data, means “Repeat _____ (portion indicated).”) See also **procedure word**. (FM 24-19)

scatterable mine – (DOD, NATO) In land mine warfare, a mine laid without regard to classical pattern and which is designed to be delivered by aircraft, artillery, missile, ground dispenser, or by hand. Once laid, it normally has a limited life. See also **mine**. See FM 20-32. See page 7-48 for symbol.

scheduled fire – (DOD, NATO) A type of prearranged fire executed at a predetermined time. See FM 6-20-10.

scheduled supplies – Requirements that can be reasonably predicted. A schedule supply normally will not require a requisition to be submitted by the user for its replacement. Requirements are based on troop strength, equipment density, forecasts, and daily usage factors. Classes of supply I, III (bulk), V, and VI normally are treated as scheduled supplies. (FM 4-0)

scheduled target(s) – (DOD) Planned targets upon which fire will be delivered at a specific time. [Note: the Army definition also applies to mortar fire.] [Note: see APP-6.] See also **on-call target**; **planned target(s)**. See FM 6-20-40.

schedule of fire – (DOD) Groups of fires or series of fires fired in a definite sequence according to a definite program. The time of starting the schedule may be ON CALL. For identification purposes, schedules may be referred to by code name or other designation. See FM 6-20.

schedule of targets – (DOD, NATO) In artillery, mortar, [Note: the NATO definition does not include “mortar”] and naval gunfire support, individual targets, groups, or series of targets to be fired on, in a definite sequence according to a definite program. See FM 6-20-30.

scheme of maneuver – (DOD) Description of how arrayed forces will accomplish the commander’s intent. It is the central expression of the commander’s concept for operations and governs the design of supporting plans or annexes. See FM 101-5.

science of control – Use of objectivity, facts, empirical methods, and analysis, with emphasis on anticipation in the form of forecasting to regulate forces and functions to accomplish the mission in accordance with the commander’s intent. See FM 6-0.

science of tactics – The understanding of those military aspects of tactics—capabilities, techniques and procedures—that can be measured and codified. (FM 3-90)

scientific and technical intelligence – (DOD) The product resulting from the collection, evaluation, analysis, and interpretation of foreign scientific and technical information that covers: a. foreign developments in basic and applied research and in applied engineering techniques; and b. scientific and technical characteristics, capabilities, and limitations of all foreign military systems, weapons, weapon systems, and materiel; the research and development related thereto; and the production methods employed for their manufacture. Also called **S&TI**. See also **intelligence**; **technical intelligence**. See FM 34-2.

screen – (DOD, NATO) 1. An arrangement of ships, aircraft, and/or submarines to protect a main body or convoy. 2. In cartography, a sheet of transparent film, glass, or plastic carrying a “ruling” or other regularly repeated pattern which may be used in conjunction with a mask, either photographically or photomechanically, to produce areas of patterns. 3. In surveillance, camouflage, and concealment, any natural or artificial material, opaque to surveillance sensors, interposed between the sensor(s) and the object to be camouflaged or concealed. 4. A security element whose primary task is to observe, identify, and report information, and which only fights in self-protection. See FM 3-90. 5. (DOD only) A task to maintain surveillance; provide early warning to the main body; or impede, destroy, and harass enemy reconnaissance within its capability without becoming decisively engaged. (Army) A form of security operation that primarily provides early warning to the protected force. (FM 3-90) See also **concealment**; **flank guard**; **guard**; **security operations**. (See page A-5 for symbol.)

screening – As it applies to human intelligence operations, the process of evaluating and selecting human and document sources based on pre-established criteria for the prioritized collection of information in support of command intelligence requirements. While screening is not in itself an information collection technique, it is vital to the rapid collection of information. (FM 34-52)

screen line – A control measure, usually named as a phase line, established forward of the main body during defensive operations, or during offensive operations as a flank or rear screen oriented on the main body. Once occupied, it becomes the forward line of own troops and the limit of advance for all friendly forces, although permission can be obtained from the establishing headquarters to go beyond it. See also **screen**; **security**. (FM 3-90)

S-day – (DOD) The day the President authorizes Selective Reserve callup (not more than 200,000). See also **times**. See FM 101-5.

sea port – (DOD) A land facility designated for reception of personnel or materiel moved by sea, and that serves as an authorized port of entrance into or departure from the country in which it is located. See also **aerial port**; **port of debarkation**; **port of embarkation**. See FM 4-01.30.

sea port of debarkation – A marine terminal for sustained port operations at which personnel and materiel are discharged from ships. Sea ports of debarkation normally act as ports of embarkation on return passenger and retrograde cargo shipments. Also called **SPOD**. (FM 4-01.30) (See page 5-25 for symbol.)

sea port of embarkation – A marine terminal for sustained port operations at which personnel board and materiel is loaded aboard ships. Sea ports of embarkation normally act as ports of debarkation on return passenger and retrograde cargo shipments. Also called **SPOE**. (FM 4-01.30) (See page 5-25 for symbol.)

search and attack – A technique of conducting a movement to contact that shares many of the characteristics of an area security mission. (FM 3-0)

sector of fire – (DOD, NATO) A defined area which is required to be covered by the fire of individual or crew-served weapons or the weapons of a unit. (Army) That area assigned to a unit, crew-served weapon, or an individual weapon within which it will engage targets as they appear in accordance with established engagement priorities. (FM 3-90)

secure – (DOD, NATO) In an operational context, to gain possession of a position or terrain feature with or without force, and to make such disposition as will prevent, as far as possible, its destruction or loss by enemy action. See FM 3-90. (Army) 1. A tactical mission task that involves preventing a unit, facility, or geographical location from being damaged or destroyed as a result of enemy action. (FM 3-90) 2. One of the five breaching fundamentals. Those actions which eliminate the enemy's ability to interfere with the reduction and passage of combat power through a lane. Secure may be accomplished by maneuver or by fires. (FM 3-34.2) See also **assault**; **breach**; **denial measure**; **reduce**; **suppress**. (See page A-5 for symbol.)

security – (DOD) 1. Measures taken by a military unit, an activity or installation to protect itself against all acts designed to, or which may, impair its effectiveness. 2. A condition that results from the establishment and maintenance of protective measures that ensure a state of inviolability from hostile acts or influences. 3. With respect to classified matter, the condition that prevents unauthorized persons from having access to official information that is safeguarded in the interests of national security. (NATO) The condition achieved when designated information, materiel, personnel, activities, and installations are protected against espionage, sabotage, subversion, and terrorism, as well as against loss or unauthorized disclosure. (Army) One of the nine principles of war: Never permit the enemy to acquire an unexpected advantage. See also **principles of war**. (FM 3-0)

security area (zone) – (Army) Area that begins at the forward area of the battlefield and extends as far to the front and flanks as security forces are deployed. Forces in the security area furnish information on the enemy and delay, deceive, and disrupt the enemy and conduct counterreconnaissance. (FM 3-90) (Marine Corps) The forward of the three echelons of a defensive sector. It is the area forward of the forward edge of the battle area out to the forward positions initially assigned to the security forces. The ground combat element commander may extend the lateral boundaries of subordinate units forward of the forward edge of the battle area, giving them responsibility for the security area within sector to the forward limit of their boundaries, or he may assign a security force to operate across the entire ground combat element frontage.

security assistance – (DOD) Group of programs authorized by the Foreign Assistance Act of 1961, as amended, and the Arms Export Control Act of 1976, as amended, or other related statutes by which the United States provides defense articles, military training, and other defense-related services, by grant, loan, credit, or cash sales in furtherance of national policies and objectives. Also called **SA**. See FM 3-0.

security operations – Those operations undertaken by a commander to provide early and accurate warning of enemy operations, to provide the force being protected with time and maneuver space within which to react to the enemy, and to develop the situation to allow the commander to effectively use the protected force. See also **cover**; **guard**; **rear area response forces**; **screen**. (FM 3-90)

seize – (DOD) To employ combat forces to occupy physically and control a designated area. (Army) A tactical mission task that involves taking possession of a designated area using overwhelming force. (FM 3-90) (Marine Corps) To clear a designated area and obtain control of it. See also **contain**. (See page A-6 for symbol.)

selective identification feature – (DOD) A capability that, when added to the basic identification friend or foe system, provides the means to transmit, receive, and display

selected coded replies. Also called **SIF**. See also **identification friend or foe; identification friend or foe on/off line**. See FM 3-04.111.

selective mobilization – (DOD) Expansion of the active Armed Forces resulting from action by Congress and/or the President to mobilize Reserve Component units, Individual Ready Reservists, and the resources needed for their support to meet the requirements of a domestic emergency that is not the result of an enemy attack. See also **mobilization**. See FM 100-17.

sensor – Equipment which detects, and may indicate and/or record, objects and activities by means of energy or particles emitted, reflected, or modified by objects. (FM 34-1) (See page 6-26 for symbol.)

separation zone – (DOD, NATO) An area between two adjacent horizontal or vertical areas into which units are not to proceed unless certain safety measures can be fulfilled. See FM 3-07.

sequel – (DOD) A major operation that follows the current major operation. Plans for a sequel are based on the possible outcomes (success, stalemate, or defeat) associated with the current operation. See FM 3-0.

serial – (DOD, NATO) An element or a group of elements within a series which is given a numerical or alphabetical designation for convenience in planning, scheduling, and control. [Note: the NATO definition ends here.] A serial can be a group of people, vehicles, equipment, or supplies and is used in airborne, air assault, and amphibious operations and convoys. See FM 90-26.

serial assignment table – (DOD) A table that is used in amphibious operations and shows the serial number, the title of the unit, the approximate number of personnel; the material, vehicles, or equipment in the serial; the number and type of landing craft and/or amphibious vehicles required to boat the serial; and the ship on which the serial is embarked. [Note: the Army definition adds: “Also used in airborne and air assault operations, and may be used in noncombatant evacuation operations.”] See FM 90-26.

series of targets – (NATO) In artillery and naval fire support, a number of targets and/or group(s) of targets planned to support a maneuver phase. A series of targets is indicated by a nickname. [Note: the Army definition also applies to mortar fire.] See FM 6-20-40. (Marine Corps) A number of targets and/or groups of targets fired in a predetermined sequence in support of a scheme of maneuver. (See page 7-39 for symbol.)

service – A procedure word meaning, “The message that follows is a service message.” See also **procedure word**. (FM 24-19)

service ammunition – (DOD) Ammunition intended for combat, rather than for training purposes. See FM 3-21.91.

Service component command – (DOD) A command consisting of the Service component commander and all those Service forces, such as individuals, units, detachments, organizations, and installations under that command, including the support forces that have been assigned to a combatant command or further assigned to a subordinate unified command or joint task force. See also **functional component command**. See FM 3-0. (See page 5-36 for symbols.)

Service military deception – (DOD) Military deception planned and executed by the Services that applies to Service support to joint operations. Service military deception is designed to protect and enhance capabilities of Service forces and systems. See also **military deception**. See FM 3-13.

severity – The expected consequence of an event (hazardous incident) in terms of degree of injury, property damage, or other mission-impairing factors (loss of combat power, and so on) that could occur. There are four degrees of severity: catastrophic (I), critical (II), marginal (III), and negligible (IV). (FM 100-14)

shallow fording – (DOD) The ability of a self-propelled gun or ground vehicle equipped with built-in waterproofing, with its wheels or tracks in contact with the ground, to negotiate a water obstacle without the use of a special waterproofing kit. See also **ford**. See FM 5-100.

shaped charge – (DOD, NATO) A charge shaped so as to concentrate its explosive force in a particular direction. See FM 5-250.

shaping – (Marine Corps) The use of lethal and nonlethal activities to influence events in a manner which changes the general condition of war to an advantage.

shaping operations – Operations at any echelon that create and preserve conditions for the success of decisive operations. (FM 3-0)

sheaf – In artillery, mortar and naval gunfire support, planned planes (lines) of fire that produce a desired pattern of bursts with rounds fired in two or more weapons. (FM 6-30)

shelling report – (NATO) Any report of enemy shelling containing information on caliber, direction, time, density and area shelled. See FM 101-5-2.

shift fire – The command to move the cone of fire in a direction away from a friendly maneuvering force so that enemy forces continue to be struck by the beaten zone at the same time the friendly unit moves. (FM 6-20-40)

shore party – (DOD, NATO) A task organization of the landing force, formed for the purpose of facilitating the landing and movement off the beaches of troops, equipment, and supplies; for the evacuation from the beaches of casualties and enemy prisoners of war; and for facilitating the beaching, retraction, and salvaging of landing ships and craft. It comprises elements of both the naval and landing forces. Also called **beach group**.

short – (NATO) In artillery and naval fire support, a spotting, or an observation, used by an observer to indicate that a burst(s) occurred short of the target in relation to the spotting line. [Note: the Army definition also applies to mortar fire.] (Army) In direct fire, a sensing of a round hitting below the target or between the target and the firing system. (FM 6-30)

short-range air defense engagement zone – (DOD) In air defense, that airspace of defined dimensions within which the responsibility for engagement of air threats normally rests with short-range air defense weapons. It may be established within a low- or high-altitude mission engagement zone. Also called **SHORADEZ**. See FM 3-52.

shot – (NATO) In artillery and naval fire support, a report that indicates a gun or guns have been fired. [Note: the Army definition also applies to mortar fire.] (Army) A message sent to the observer to alert him that rounds for his call for fire are in the air and prepared to

provide a sensing of the relation of their impact to the target. See also **rounds complete**. (FM 6-30)

show of force – (DOD) An operation designed to demonstrate US resolve that involves increased visibility of US deployed forces in an attempt to defuse a specific situation that, if allowed to continue, may be detrimental to US interests or national objectives. See also **deception**. See FM 3-0.

signal operation instructions – (DOD) A series of orders issued for technical control and coordination of the signal communication activities of a command. In Marine Corps usage, these instructions are designated communication operation instructions. [Note: the Army term is “signal operating instructions.”] Also called **SOI**. See FM 11-32.

signal security – (DOD) A generic term that includes both communications security and electronics security. (Army) Measures intended to deny or counter hostile exploitation of electronic emissions. Signal security includes communications security and electronic security. Also called **SIGSEC**. See also **security**. (FM 11-32)

signals intelligence – (DOD) 1. A category of intelligence comprising either individually or in combination all communications intelligence, electronic intelligence, and foreign instrumentation signals intelligence, however transmitted. 2. Intelligence derived from communications, electronics, and foreign instrumentation signals. Also called **SIGINT**. See also **communications intelligence; electronic intelligence; intelligence**. See FM 34-2.

silence – A procedure word meaning, “Cease transmission immediately.” Silence will be maintained until lifted. (Transmissions imposing silence must be authenticated.) See also **procedure word**. (FM 24-19)

silence lifted – A procedure word meaning, “Silence is lifted.” (When an authentication system is in force, the transmission lifting silence is to be authenticated.) See also **procedure word**. (FM 24-19)

simplicity – One of the nine principles of war: Prepare clear, uncomplicated plans, and clear, concise orders to ensure thorough understanding. (FM 3-0)

simulative electromagnetic deception – (DOD) Actions to simulate friendly, notional, or actual capabilities to mislead hostile forces. See also **electromagnetic deception; imitative electromagnetic deception; manipulative electromagnetic deception**. See FM 3-13.

situational awareness – (Marine Corps) Knowledge and understanding of the current situation which promotes timely, relevant, and accurate assessment of friendly, enemy, and other operations within the battlespace in order to facilitate decisionmaking. An informational perspective and skill that foster an ability to determine quickly the context and relevance of events that are unfolding.

situational obstacle – An obstacle that a unit plans and possibly prepares prior to starting an operation, but does not execute unless specific criteria are met. It provides the commander flexibility for emplacing tactical obstacles based on battlefield development. (FM 90-7)

situational understanding – (Army) The product of applying analysis and judgment to the common operational picture to determine the relationship among the factors of METT-TC. (FM 3-0)

situation map – (DOD, NATO) A map showing the tactical or the administrative situation at a particular time. Also called **SITMAP**. See also **map**; **overlay**. See FM 101-5.

situation template – (DOD) A depiction of assumed adversary dispositions, based on adversary doctrine and the effects of the battlespace if the adversary should adopt a particular course of action. In effect, the situation templates are the doctrinal templates depicting a particular operation modified to account for the effects of the battlespace environment and the adversary's current situation (training and experience levels, logistic status, losses, dispositions). Normally, the situation template depicts adversary units two levels of command below the friendly force, as well as the expected locations of high-value targets. Situation templates use time-phase lines to indicate movement of forces and the expected flow of the operation. Usually the situation template depicts a critical point in the course of action. Situation templates are one part of an adversary course of action model. Models may contain more than one situation template. See also **course of action**; **doctrinal template**. See FM 34-130.

skin decontamination technique – Process of removing or neutralizing contamination on the skin within one minute of exposure to prevent it from penetrating into the skin. Immediate decontamination techniques are skin decontamination, personal wipedown, and operator's spraydown. (FM 3-5)

small-scale map – (DOD) A map having a scale smaller than 1:600,000. See also **map**. See FM 3-25.26.

smoke blanket – A dense horizontal concentration of smoke covering an area of ground with visibility inside the concentration less than 50 meters. The blanket is established over and around friendly areas to protect them from air visual observation and visual precision bombing attacks, or established over enemy areas to protect attacking friendly aircraft from enemy air defense. (FM 3-50)

smoke curtain – A vertical smoke screen. See also **smoke screen**. (FM 3-50)

smoke screen – (DOD) A cloud of smoke used to conceal ground maneuver, obstacle breaching, recovery operations, and amphibious assault operations as well as key assembly areas, supply routes, and logistics facilities. (NATO) Cloud of smoke used to mask either friendly or enemy installations or maneuvers. See FM 3-50.

solid waste – Any material or substance (solid or liquid) which is inherently waste-like by being no longer suitable for its originally intended purpose. See also **hazardous waste**; **waste**. (FM 3-100.4)

soman – A g-series nerve agent. Also called **GD**. (FM 3-9)

sortie – (DOD, NATO) In air operations, an operational flight by one aircraft. See FM 3-04.111.

sorting – See **triage**.

source – (DOD) 1. A person, thing, or activity from which information is obtained. 2. In clandestine activities, a person (agent), normally a foreign national, in the employ of an intelligence activity for intelligence purposes. 3. In interrogation activities, any person who furnishes information, either with or without the knowledge that the information is being used for intelligence purposes. In this context, a controlled source is in the employment or under the control of the intelligence activity and knows that the information is to be used for

intelligence purposes. An uncontrolled source is a voluntary contributor of information and may or may not know that the information is to be used for intelligence purposes. See FM 34-1.

source management – Processes and administrative procedures used to control, orchestrate, and deconflict all actions pertaining to individuals utilized by human intelligence collectors and counterintelligence special agents to obtain information requirements. (FM 34-52)

source reduction – The decrease of hazardous waste generation at its sources. This reduction is to be achieved through product substitution, recycling, and inventory control, and by developing new industrial processes that use less hazardous materials, such as bead blasting rather than solvents to remove paint. (FM 3-100.4)

space defense – (DOD) All defensive measures designed to destroy attacking enemy vehicles (including missiles) while in space, or to nullify or reduce the effectiveness of such attack. See also **aerospace defense**. See FM 100-18.

space operations – The employment of space system capabilities that provide the means to enhance command and control, facilitate the maneuver of forces, reduce the commander's uncertainty, and improve fire support, air defense, intelligence collection, and combat service support operations which will support strategic, operational, and tactical missions across the operational continuum in the near, mid, and far term. (FM 100-18)

speak slower – A procedure word meaning, "Your transmission is at too fast a speed. Reduce speed of transmission." See also **procedure word**. (FM 24-19)

special activities – (DOD) Activities conducted in support of national foreign policy objectives that are planned and executed so that the role of the US government is not apparent or acknowledged publicly. They are also functions in support of such activities but are not intended to influence US political processes, public opinion, policies, or media and do not include diplomatic activities or the collection and production of intelligence or related support functions. See FM 100-25.

special air operation – (DOD) An air operation conducted in support of special operations and other clandestine, covert, and psychological activities. See FM 100-25.

special forces operations base – (DOD) A command, control, and support base established and operated by a special forces group or battalion from organic and attached resources. The base commander and his staff coordinate and synchronize the activities of subordinate and forward-deployed forces. A special forces operations base is normally established for an extended period of time to support a series of operations. [Note: Army special forces use the term "special forces operational base."] See FM 100-25.

special operations – (DOD) Operations conducted by specially organized, trained, and equipped military and paramilitary forces to achieve military, political, economic, or informational objectives by unconventional military means in hostile, denied, or politically sensitive areas. These operations are conducted across the full range of military operations, independently or in coordination with operations of conventional, non-special operations forces. Political-military considerations frequently shape special operations, requiring clandestine, covert, or low visibility techniques and oversight at the national level. Special operations differ from conventional operations in degree of physical and political risk, operational techniques, mode of employment, independence from friendly support, and

dependence on detailed operational intelligence and indigenous assets. Also called **SO**. See FM 100-25.

special operations forces – (DOD) Those Active and Reserve Component forces of the Military Services designated by the Secretary of Defense and specifically organized, trained, and equipped to conduct and support special operations. Also called **SOF**. See also **Army special operations forces**. See FM 100-25. (See page 5-30 for symbols.)

special operations-peculiar – (DOD) Equipment, material, supplies, and services required for special operations missions for which there is no Service-common requirement. These are limited to items and services initially designed for, or used by, special operations forces until adopted for Service-common use by one or more Military Service; modifications approved by the Commander, US Special Operations Command, for application to standard items and services used by the Military Services; and items and services approved by the Commander, US Special Operations Command, as critically urgent for the immediate accomplishment of a special operations mission. Also called **SO-peculiar**. See also **special operations**. See FM 100-25.

special psychological operations study – With narrower focus than a basic psychological operations study, it may address a variety of different subjects. It can cover a particular target group, a region within a country, a significant social institution, and media analysis. It can also cover local audiences' perceptions of the United States and its policies, or an issue of particular importance to the population of a given area. Also called **SPS**. (FM 3-05.30)

special purpose Marine air-ground task force – (Marine Corps) A Marine air-ground task force organized, trained, and equipped with narrowly focused capabilities. It is designed to accomplish a specific mission, often of limited scope and duration. It may be any size, but normally it is a relatively small force—the size of a Marine expeditionary unit or smaller. It may contain other Service or foreign military forces assigned or attached to the Marine air-ground task force. Also called **SPMAGTF**. See also **aviation combat element; combat service support element; command element; ground combat element; Marine air-ground task force; Marine expeditionary force; Marine expeditionary force (forward); Marine expeditionary unit; task force**.

special reconnaissance – (DOD) Reconnaissance and surveillance actions conducted by special operations forces to obtain or verify, by visual observation or other collection methods, information concerning the capabilities, intentions, and activities of an actual or potential enemy or to secure data concerning the meteorological, hydrographic, or geographic characteristics of a particular area. It includes target acquisition, area assessment, and post-strike reconnaissance. Also called **SR**. See FM 100-25.

special staff – (DOD) All staff officers having duties at headquarters and not included in the general (coordinating) staff group or in the personal staff group. The special staff includes certain technical specialists and heads of services, e.g., quartermaster officer, antiaircraft officer, transportation officer, etc. See FM 6-0.

specified combatant command – See **specified command**.

specified command – (DOD) A command that has a broad, continuing mission, normally functional, and is established and so designated by the President through the Secretary of Defense with the advice and assistance of the Chairman of the Joint Chiefs of Staff. It is

normally composed of forces from a single Military Department. Also called **specified combatant command**. See FM 100-7.

specified task – A task specifically assigned to a unit by its higher headquarters. See also **essential task**; **implied task**. (FM 101-5)

spill – A generic term that encompasses the accidental and the deliberate but unpermitted discharge or release of a pollutant. (FM 3-100.4)

splash – (NATO) 1. In artillery and naval fire support, word transmitted to an observer or spotter five seconds before the estimated time of the impact of a salvo or round. [Note: the Army definition also applies to mortar fire.] See FM 6-30. 2. In air interception, target destruction verified by visual or radar means. See FM 44-100.

split-based operation – The dividing of staff and command functions so that only those functions absolutely necessary are deployed, allowing some staff and command functions to be accomplished outside the area of operations. (FM 100-7)

spoiling attack – (DOD, NATO) A tactical maneuver employed to seriously impair a hostile attack while the enemy is in the process of forming or assembling for an attack. [Note: NATO definition ends here.] Usually employed by armored units in defense by an attack on enemy assembly positions in front of the main line of resistance or battle position. (Army) A form of attack that preempts or seriously impairs an enemy attack while the enemy is in the process of planning or preparing to attack. See also **attack**. (FM 3-0)

spot jamming – (DOD, NATO) The jamming of a specific channel or frequency. See also **barrage jamming**; **electronic warfare**; **jamming**. See FM 34-2.

spotting – (NATO) A process of determining by visual or electronic observation deviations of artillery or naval fire from the target in relation to a spotting line for the purpose of supplying necessary information for the adjustment of analysis of fire. [Note: the Army definition also applies to mortar fire.] See FM 6-20-40.

stability operations – Operations that promote and protect US national interests by influencing the threat, political, and information dimensions of the operational environment through a combination of peacetime developmental, cooperative activities and coercive actions in response to crisis. (FM 3-0)

staff estimates (DOD) – Assessments of courses of action by the various staff elements of a command that serve as the foundation of the commander's estimate. (Army) A continuous process that evaluates current and future operations to determine if a current operation is proceeding according to plan and if future operations are supportable. (FM 101-5)

staging area – (DOD) 1. Amphibious or airborne—A general locality between the mounting area and the objective of an amphibious or airborne expedition, through which the expedition or parts thereof pass after mounting, for refueling, regrouping of ships, and/or exercise, inspection, and redistribution of troops. See FM 90-26. 2. Other movements—A general locality established for the concentration of troop units and transient personnel between movements over the lines of communication. (NATO) 1. An area located between the mounting area and the objective area through which all or part of the forces pass after mounting, for the purpose of refueling, regrouping, training, inspection and distribution of troops and materiel. 2. A general locality established for the concentration of troop units and

transient personnel between movements over lines of communications. See FM 4-01.30. Also called **SA**. See also **airborne**; **marshalling**.

staging base – (DOD) 1. An advanced naval base for the anchoring, fueling, and refitting of transports and cargo ships as well as replenishment of mobile service squadrons. 2. A landing and take-off area with minimum servicing, supply, and shelter provided for the temporary occupancy of military aircraft during the course of movement from one location to another. See FM 3-04.111.

staging field – A predetermined area where aircraft assemble prior to conducting an air assault operation. (FM 90-4)

staging plan – An air assault operation plan that is based on the loading plan and prescribes the arrival time of the ground units (troops, equipment, and supplies) at the pickup zone in the proper order for movement. (FM 90-4)

standard pattern – (DOD, NATO) In land mine warfare, the agreed pattern to which mines are normally laid. See FM 20-32.

standard use Army aircraft flight route – (DOD) Routes established below the coordinating altitude to facilitate the movement of Army aviation assets. Routes are normally located in the corps through brigade rear areas of operation, and do not require approval by the airspace control authority. Also called **SAAFR**. See FM 3-52. (See page 7-19 for symbol.)

standing operating procedure – (DOD, NATO) A set of instructions covering those features of operations which lend themselves to a definite or standardized procedure without loss of effectiveness. The procedure is applicable unless ordered otherwise. Also called **SOP**. See FM 6-0.

start point – (NATO) A well defined point on a route at which a movement of vehicles begins to be under the control of the commander of this movement. It is at this point that the column is formed by the successive passing, at an appointed time, of each of the elements composing the column. In addition to the principal start point of a column there may be secondary start points for its different elements. A location on the route where the marching element falls under the control of a designated march commander. Also called **SP**. See FM 55-30. (See page 7-43 for symbol.)

state of readiness—state 1—safe – (DOD) The state of a demolition target upon or within which the demolition charge has been placed and secured. The firing or initiating circuits have been installed, but not connected to the demolition charge. Detonators or initiators have not been connected or installed. (NATO) The state of a demolition target in which charges are in place. The firing circuit may be in place, but the detonators are not installed and the means of firing are not connected. See FM 5-250. (See page 7-51 for symbol.)

state of readiness—state 2—armed – (DOD, NATO) The state of a demolition target in which the demolition charges are in place, the firing and priming circuits are installed and complete, and the charge is ready for immediate firing. [Note: the NATO definition does not include “and the charge is.”] See FM 5-250. (See page 7-51 for symbol.)

status-of-forces agreement – (DOD) An agreement that defines the legal position of a visiting military force deployed in the territory of a friendly state. Agreements delineating the status of visiting military forces may be bilateral or multilateral. Provisions pertaining to the status of visiting forces may be set forth in a separate agreement, or they may form a part of a more

comprehensive agreement. These provisions describe how the authorities of a visiting force may control members of that force and the amenability of the force or its members to the local law or to the authority of local officials. To the extent that agreements delineate matters affecting the relations between a military force and civilian authorities and population, they may be considered as civil affairs agreements. Also called **SOFA**. See also **stability operations**; **support operations**. See FM 3-07.

stay behind force – (DOD, NATO) A force which is left in position to conduct a specified mission when the remainder of the force withdraws or retires from the area. See FM 3-90.

stay behind operation – An operation in which the commander leaves a unit in position to conduct a specified mission while the remainder of his forces withdraw or retire from the area. (FM 3-90)

sterilizer – (DOD, NATO) In mine warfare, a device included in mines to render the mine permanently inoperative on expiration of a predetermined time after laying. See FM 20-32.

stick (air transport) – (DOD) A number of paratroopers who jump from one aperture or door of an aircraft during one run over a drop zone. See FM 90-26.

store – An information management activity: to retain relevant information in any form, usually for orderly, timely retrieval and documentation, until it is needed for exercising command and control. (FM 6-0)

straggler – (DOD, NATO) 1. Any personnel, vehicles, ships, or aircraft which, without apparent purpose or assigned mission, become separated from their unit, column or formation. 2. A ship separated from its convoy by more than 5 nautical miles, through inability to keep up, and unable to rejoin before dark, or over 10 nautical miles from its convoy whether or not it can rejoin before dark. See FM 3-19.4.

straggler control – Operations conducted to regulate friendly forces who have become separated from their commands by events on the battlefield. (FM 3-19.4)

strategic level of war – (DOD) The level of war at which a nation, often as a member of a group of nations, determines national or multinational (alliance or coalition) strategic security objectives and guidance, and develops and uses national resources to accomplish these objectives. Activities at this level establish national and multinational military objectives; sequence initiatives; define limits and assess risks for the use of military and other instruments of national power; develop global plans or theater war plans to achieve these objectives; and provide military forces and other capabilities in accordance with strategic plans. See also **operational level of war**; **tactical level of war**. See FM 3-0.

strategic military deception – (DOD) Military deception planned and executed by and in support of senior military commanders to result in adversary military policies and actions that support the originator's strategic military objectives, policies, and operations. See also **military deception**. See FM 3-13.

strategic mobility – (DOD) The capability to deploy and sustain military forces worldwide in support of national strategy. See also **mobility**. See FM 100-17.

strategic psychological activities – (DOD, NATO) Planned psychological activities in peace, crisis, and war which pursue objectives to gain the support and cooperation of friendly and

neutral countries and to reduce the will and the capability of hostile or potentially hostile countries to wage war. See FM 3-05.30.

strategy – (DOD) The art and science of developing and employing instruments of national power in a synchronized and integrated fashion to achieve theater, national and/or multinational objectives. See FM 3-0.

strike warning – Warning given in advance of a friendly nuclear attack to ensure that friendly forces are able to protect themselves from its effects. Also called **STRIKWARN**. (FM 100-30)

striking force – A committed force organized to conduct the decisive attack in a mobile defense. It normally comprises the maximum combat power available to the commander at the time of the attack. (FM 3-0)

strong point – (DOD, NATO) A key point in a defensive position, usually strongly fortified and heavily armed with automatic weapons, around which other positions are grouped for its protection. (Army) A heavily fortified battle position tied to a natural or reinforcing obstacle to create an anchor for the defense or to deny the enemy decisive or key terrain. Also called **SP**. See also **battle position; mobile defense**. (FM 3-90) (See page 7-25 for symbols.)

subordinates' initiative – The assumption of responsibility for deciding and initiating independent actions when the concept of operations or order no longer applies or when an unanticipated opportunity leading to the accomplishment of the commander's intent presents itself. See also **initiative (operational)**. (FM 6-0)

subsequent position – A position that a unit expects to move to during the course of battle. (FM 3-90)

subversion – (DOD) Action designed to undermine the military, economic, psychological, or political strength or morale of a regime. See also **unconventional warfare**. See FM 3-07.

supervised route – (DOD, NATO) In road traffic, a roadway over which limited control is exercised by means of traffic control posts, traffic patrols, or both. Movement credit is required for its use by a column of vehicles or a vehicle of exceptional size and weight. See also **route**. See FM 4-01.30.

supplementary position – A defensive position located within a unit's assigned area of operation that provides the best sectors of fire and defensive terrain along an avenue of approach that is not the primary avenue along where the enemy is expected to attack. See also **alternation position; battle position; successive positions**. (FM 3-90)

supply – The acquiring, receiving, storing, and issuing of all classes of supply, except Class VIII, required to equip and sustain Army forces. (FM 4-0)

supply control – (DOD) The process by which an item of supply is controlled within the supply system, including requisitioning, receipt, storage, stock control, shipment, disposition, identification, and accounting. See FM 4-0.

supply discipline – Command responsibility to identify and redistribute excess materials, observe senior commander's priorities, and ensure subordinates operate within the legal boundaries of the logistics system. (FM 4-0)

supply point – (DOD) A location where supplies, services, and materials are located and issued. These locations are temporary and mobile, normally being occupied for up to 72 hours.

(NATO) Any point where supplies are issued in detail. See FM 4-0. (See page 7-65 for symbols.)

supply point distribution – A method of distributing supplies to the receiving unit at a supply point, railhead, or truckhead. The unit then moves the supplies to its own area using its own transportation. (FM 4-0)

supply site – A location where supplies, services, and materials are located or stored in a permanent or semipermanent facility. (FM 4-0)

support – (DOD) 1. The action of a force that aids, protects, complements, or sustains another force in accordance with a directive requiring such action. 2. A unit which helps another unit in battle. 3. An element of a command which assists, protects, or supplies other forces in combat. See also **common servicing**; **direct support**; **general support**; **mutual support**. See FM 101-5.

support area – A designated area in which combat service support elements and some staff elements locate to support a unit. (FM 4-0) (See page 7-70 for symbol.)

support by fire – A tactical mission task in which a maneuver force moves to a position where it can engage the enemy by direct fire in support of another maneuvering force. See also **attack by fire**; **overwatch**. (FM 3-90) (See page 7-32 for symbol.)

support force – That force in a breaching operation whose mission is to eliminate enemy interference with the breach through suppressive, direct, and indirect fires. The support force is one of the three breach organizations used in breaching operations. See also **breach force**. (FM 3-34.2)

supporting distance – The distance between two units that can be traveled in time for one to come to the aid of the other. For small units, it is the distance between two units that can be covered effectively by their fires. (FM 3-0)

supporting forces – (DOD) Forces stationed in or to be deployed to an operational area to provide support for the execution of an operation order. Combatant command (command authority) of supporting forces is not passed to the supported commander. See FM 101-5.

supporting perceptions – Mental images that enhance the likelihood that the deception target will form the desired perceptions and accept them as true. See also **deception target**. (FM 3-13)

supporting range – The distance one unit may be geographically separated from a second unit, yet remain within the maximum range of the second unit's indirect fire weapon systems. (FM 3-0)

support operations – Operations that employ Army forces to assist civil authorities, foreign or domestic, as they prepare for or respond to crises and relieve suffering. (FM 3-0)

suppress – 1. A tactical mission task that results in temporary degradation of the performance of a force or weapons system below the level needed to accomplish the mission. (FM 3-90)
2. One of the five breaching fundamentals. The focus of all fires on enemy personnel, weapons, or equipment to prevent effective fires on friendly forces. The purpose of suppression is to protect forces reducing and maneuvering through the obstacle and to soften

the initial foothold. (FM 3-34.2) See also **breaching fundamentals**. (See page A-6 for symbol.)

suppression – (DOD) Temporary or transient degradation by an opposing force of the performance of a weapons system below the level needed to fulfill its mission objectives. See FM 3-90.

suppression of enemy air defenses – (DOD) That activity which neutralizes, destroys, or temporarily degrades surface-based enemy air defenses by destructive and/or disruptive means. Also called **SEAD**. See FM 6-20-60.

suppressive fire – (DOD) Fires on or about a weapons system to degrade its performance below the level needed to fulfill its mission objectives, during the conduct of the fire mission. (Army) Any engagement that does not have a definite or visible target. Firing in the general direction of a known or suspected enemy location. See also **fire**. (FM 3-22.9)

surface water – All water naturally open to the atmosphere (rivers, lakes, reservoirs, ponds, streams, impoundments, seas, estuaries, etc.) and all springs, wells, or other collectors directly influenced by surface water. (FM 3-100.4)

surprise – One of the nine principles of war: Strike the enemy at a time or place or in a manner for which he is unprepared. See also **principles of war**. (FM 3-0)

surveillance – (DOD, NATO) The systematic observation of aerospace, surface or subsurface areas, places, persons, or things by visual, aural, electronic, photographic, or other means. See also **sensor**. See FM 34-1.

survey – (DOD) The directed effort to determine the location and the nature of chemical, biological, and radiological hazard within an area. See FM 3-19.

survivability – (DOD) Concept which includes all aspects of protecting personnel, weapons, and supplies while simultaneously deceiving the enemy. Survivability tactics include building a good defense; employing frequent movement; using concealment, deception, and camouflage; and constructing fighting and protective positions for both individuals and equipment. [Note: The Army definition adds, “Encompasses planning and locating position sites, designing adequate overhead cover, analyzing terrain conditions and construction materials, selecting excavation methods, and countering the effects of direct and indirect fire weapons.”] See FM 5-103. (Marine Corps) The degree to which a system is able to avoid or withstand a manmade hostile environment without suffering an abortive impairment of its ability to accomplish its designated mission.

survivability operations – The development and construction of protective positions, such as earth berms, dug-in positions, overhead protection, and countersurveillance means, to reduce the effectiveness of enemy weapon systems. (FM 5-103)

survival, evasion, resistance, and escape – Training and actions taken by military members to assist them in surviving in hostile environments, resisting enemy activities, escaping enemy forces, and evading enemy forces until the individual or unit can be reunited with friendly forces. Also called **SERE**. (FM 3-04.111)

susceptibility – (DOD, NATO) The vulnerability of a target audience to particular forms of psychological operations approach. See FM 3-05.30.

suspect – (DOD) 1. In counterdrug operations, a track of interest where correlating information actually ties the track of interest to alleged illegal drug operations. 2. An identity applied to a track that is potentially hostile because of its characteristics, behavior, origin, or nationality. See FM 1-02. See also **counterdrug; friendly; hostile; neutral**. (See page 4-3 for symbol.)

sustained rate of fire – (DOD, NATO) Actual rate of fire that a weapon can continue to deliver for an indefinite length of time without seriously overheating. [Note: the Army definition adds, "... or without doing other mechanical damage to the weapon or weapon system."] See FM 3-21.91.

sustaining operations – Operations at any echelon that enable shaping and decisive operations by providing combat service support, rear area and base security, movement control, terrain management, and infrastructure development. (FM 3-0)

sweep jamming – (DOD, NATO) A narrow band of jamming that is swept back and forth over a relatively wide operating band of frequencies. See FM 34-1.

sympathetic detonation – (DOD, NATO) Detonation of a charge by exploding another charge adjacent to it. See FM 5-250.

synchronization – (DOD) 1. The arrangement of military actions in time, space, and purpose to produce maximum relative combat power at a decisive place and time. See FM 3-0. 2. In the intelligence context, application of intelligence sources and methods in concert with the operational plan. See FM 34-2.

synchronization matrix – A format for the staff to record the results of wargaming and synchronize the course of action across time, space, and purpose in relation to an enemy course of action. (FM 101-5)

—T—

tabun – A g-series nerve agent. Also called **GA**. (FM 3-9)

tactical air control party – (NATO) A subordinate operational component of a tactical air control system designed to provide air liaison to land forces and for the control of aircraft. See FM 3-52. (Marine Corps) In the Marine Corps, tactical air control parties are organic to infantry divisions, regiments, and battalions. Tactical air control parties establish and maintain facilities for liaison and communications between parent units and airspace control agencies, inform and advise the ground unit commander on the employment of supporting aircraft, and request and control air support. Also called **TACP**.

tactical air liaison officer – An Air Force officer who works at the division or higher rear command post G-4 section and facilitates the coordination of cargo aircraft. He maintains information on runway availability, cargo handling capability, and the location of brigade medical treatment facilities and landing areas. Also called **TALO**. (FM 6-0)

tactical air operation – (DOD) An air operation involving the employment of air power in coordination with ground or naval forces to: a. gain and maintain air superiority; b. prevent movement of enemy forces into and within the objective area and to seek out and destroy these forces and their supporting installations; c. join with ground or naval forces in operations within the objective area in order to assist directly in attainment of their immediate objective. See also **air interdiction; allocation; apportionment; close air support; counterair**. See FM 3-04.111.

tactical air reconnaissance – (DOD) The use of air vehicles to obtain information concerning terrain, weather, and the disposition, composition, movement, installations, lines of communications, electronic and communication emissions of enemy forces. Also included are artillery and naval gunfire adjustment, and systematic and random observation of ground battle areas, targets, and/or sectors of airspace. See also **air reconnaissance**. See FM 34-1.

tactical ballistic missile predicted ground impact point – An elliptical area that indicates where a tactical ballistic missile (TBM) most likely will strike the ground. This area varies in size based on the known or suspected accuracy of the TBM if it functions normally. Also called **TBMPGIP**. See also **theater missile defense**. (FM 44-100)

tactical combat force – (DOD) A combat unit, with appropriate combat support and combat service support assets, that is assigned the mission of defeating Level III threats. Also called **TCF**. See also **rear area response force**. See FM 3-90.

tactical command – (DOD) The authority delegated to a commander to assign tasks to forces under his command for the accomplishment of the mission assigned by higher authority. Also called **TACOM**. See FM 100-8.

tactical command post – The forward echelon of a headquarters. The tactical command post consists of representatives from G-/S-2 and G-/S-3, fire support, tactical air control party, air defense artillery engineers, and combat service support liaison (G-/S-1, G-/S-4) elements. It is located well forward on the battlefield so that the commander has a command post near subordinate commanders and can directly influence operations. Also called **TAC CP**. See also **command post**. (See page 5-39 for symbol.)

tactical control – (DOD) Command authority over assigned or attached forces or commands, or military capability or forces made available for tasking, that is limited to the detailed direction and control of movements or maneuvers within the operational area necessary to accomplish missions or tasks assigned. Tactical control is inherent in operational control. Tactical control may be delegated to, and exercised at any level at or below the level of combatant command. When forces are transferred between combatant commands, the command relationship the gaining commander will exercise (and the losing commander will relinquish) over these forces must be specified by the Secretary of Defense. Tactical control provides sufficient authority for controlling and directing the application of force or tactical use of combat support assets within the assigned mission or task. Also called **TACON**. See FM 3-0.

tactical level of war – (DOD) The level of war at which battles and engagements are planned and executed to accomplish military objectives assigned to tactical units or task forces. Activities at this level focus on the ordered arrangement and maneuver of combat elements in relation to each other and to the enemy to achieve combat objectives. See also **operational level of war**; **strategic level of war**. See FM 3-0.

tactical military deception – (DOD) Military deception planned and executed by and in support of tactical commanders to result in adversary actions that are favorable to the originator's objectives and operations. Tactical military deception is planned and conducted to support battles and engagements. See also **military deception**. See FM 3-13.

tactical minefield – (DOD) A minefield that is employed to directly attack enemy maneuver as part of a formation obstacle plan and is laid to delay, channel, or break up an enemy

advance, giving the defending element a positional advantage over the attacker. [Note: see AAP-6.] See FM 20-32.

tactical mission task – The specific activity performed by a unit while executing a form of tactical operation or form of maneuver. It may be expressed in terms of either actions by a friendly force or effects on an enemy force. See also **mission statement**; **operation order**. (FM 7-15)

tactical mobility – The ability to move rapidly from one part of the battlefield to another, relative to the enemy. (FM 3-90)

tactical obstacles – (DOD) Those obstacles employed to disrupt enemy formations, to turn them into a desired area, to fix them in position under direct and indirect fires, and to block enemy penetrations. See also **obstacle**. See FM 90-7.

tactical operations center – (DOD) A physical groupment of those elements of general and special staff concerned with the current tactical operations and the tactical support thereof. Also called **TOC**. See also **command post**. (See page 5-39 for symbol.)

tactical psychological activities – Psychological operations that are conducted in the area assigned a tactical commander during conflict and war to support the tactical mission against opposing forces. (FM 3-05.30)

tactical psychological operations team – Psychological operations unit which normally provides tactical level psychological operations support to a brigade- or equivalent-sized element, to include a Marine expeditionary unit, a special forces group, an armored cavalry regiment, a separate infantry regiment, or a brigade. Also called **TPT**. (FM 3-05.30)

tactical questioning – The expedient initial questioning of a human intelligence source directed toward the collection of priority tactical information. (FM 34-52)

tactical risk – The risk concerned with the hazards that exist because of the presence of either the enemy or an adversary. See also **accident risk**. (FM 3-100.4)

tactical road march – A rapid movement used to relocate units within an area of operations in order to prepare for combat operations. (FM 3-0)

tactics – (DOD) 1. The employment of units in combat. 2. The ordered arrangement and maneuver of units in relation to each other and/or to the enemy in order to use their full potentialities. (Army) The employment of units in combat. It includes the ordered arrangement and maneuver of units in relation to each other, the terrain, and the enemy in order to translate potential combat power into victorious battles and engagements. (FM 3-0)

tactics, techniques, and procedures (TTP) – See individual definitions for **tactics**; **techniques**; **procedures**.

tanker airlift control element – (DOD) A mobile command and control organization deployed to support strategic and theater air mobility operations at fixed, en route, and deployed locations where air mobility operational support is nonexistent or insufficient. The tanker airlift control element (TALCE) provides on-site management of air mobility airfield operations, to include command and control, communications, aerial port services, maintenance, security, transportation, weather, intelligence, and other support functions, as necessary. The TALCE is composed of mission support elements from various units and

deploys in support of peacetime, contingency, and emergency relief operations on both planned and “no notice” basis. Also called **TALCE**. See FM 4-01.30.

target – (DOD, NATO) 1. An area, complex, installation, force, equipment, capability, function, or behavior identified for possible action to support the commander’s objectives, guidance, and intent. Targets fall into two categories: planned and immediate. [Note: see AAP-6.] See FM 6-20-40. 2. In intelligence usage, a country, area, installation, agency, or person against which intelligence operations are directed. See FM 34-1. 3. An area designated and numbered for future firing. [Note: the NATO definition begins “In artillery.”] 4. In gunfire support usage, an impact burst which hits the target. [Note: see AAP-6.] See FM 6-30. (Army) An object, vehicle, individual, and so forth, which is the aiming point of any weapon system. See also **immediate target**; **objective area**; **planned target**. (FM 6-20-10) (See page 7-38 for symbols.)

target acquisition – (DOD, NATO) The detection, identification, and location of a target in sufficient detail to permit the effective employment of weapons. Also called **TA**. See also **target analysis**. See FM 6-20-10.

target analysis – (DOD, NATO) An examination of potential targets to determine military importance, priority of attack, and weapons required to obtain a desired level of damage or casualties. See also **target acquisition**. See FM 6-20-10.

target area of interest (DOD) The geographical area where high-value targets can be acquired and engaged by friendly forces. Not all target areas of interest will form part of the friendly course of action; only target areas of interest associated with high priority targets are of interest to the staff. These are identified during staff planning and wargaming. Target areas of interest differ from engagement areas in degree. Engagement areas plan for the use of all available weapons; target areas of interest might be engaged by a single weapon. (Army) [Note: the Army term is “targeted area of interest.”] The geographical area or point along a mobility corridor where successful interdiction will cause the enemy to abandon a particular course of action or require him to use specialized engineer support to continue. It is where he can be acquired and engaged by friendly forces. Also called **TAI**. (FM 3-90) (See page 7-35 for symbol.)

target array – (DOD) A graphic representation of enemy forces, personnel, and facilities in a specific situation, accompanied by a target analysis. See FM 6-20-10.

target audience – (DOD) An individual or group selected for influence or attack by means of psychological operations. See FM 3-05.30.

target audience analysis – The process by which potential target audiences are identified and analyzed for effectiveness, accessibility, and susceptibility. (FM 3-05.30)

target concentration – (DOD, NATO) A grouping of geographically proximate targets. See also **target**; **group of targets**. See FM 6-20-10.

target description – See **description of target**.

targeting – (DOD) The process of selecting and prioritizing targets and matching the appropriate response to them, taking account of operational requirements and capabilities. See FM 6-20-10.

target list – (DOD) The listing of targets maintained and promulgated by the senior echelon of command; it contains those targets that are to be engaged by supporting arms, as distinguished from a “list of targets” that may be maintained by any echelon as confirmed, suspected, or possible targets for informational and planning purposes. See also **list of targets**. See FM 6-20-40.

target of opportunity – (DOD) A target visible to a surface or air sensor or observer that is within range of available weapons and against which fire has not been scheduled or requested. See FM 6-20-40. (Army) A nuclear target observed or detected after an operation begins that has not been previously considered, analyzed, or planned for a nuclear strike. Generally fleeting in nature, it should be attacked as soon as possible within the time limitations imposed for coordination and warning of friendly troops and aircraft. (FM 100-30)

target-oriented method – A method of nuclear analysis used when detailed target information is available. It gives the best estimate of the effects that the weapon will probably have on the target. (FM 100-30)

target overlay – (DOD, NATO) A transparent sheet which, when superimposed on a particular chart, map, drawing, tracing, or other representation, depicts target locations and designations. The target overlay may also show boundaries between maneuver elements, objectives and friendly forward dispositions. See FM 6-20-40.

target range – See **range**.

target reference point – An easily recognizable point on the ground (either natural or man-made) used to initiate, distribute, and control fires. Target reference points (TRPs) can also designate the center of an area where the commander plans to distribute or converge the fires of all his weapons rapidly. They are used by task force and below, and can further delineate sectors of fire within an engagement area. TRPs are designated using the standard target symbol and numbers issued by the fire support officer. Once designated, TRPs also constitute indirect fire targets. Also called **TRP**. (FM 3-90) (See page 7-27 for symbol.)

target signature – (DOD, NATO) 1. The characteristic pattern of a target displayed by detection and identification equipment. See FM 34-1. 2. In naval mine warfare, the variation in the influence field produced by the passage of a ship or sweep.

task force – (DOD, NATO) 1. A temporary grouping of units, under one commander, formed for the purpose of carrying out a specific operation or mission. 2. A semi-permanent organization of units, under one commander, formed for the purpose of carrying out a continuing specific task. 3. A component of a fleet organized by the commander of a task fleet or higher authority for the accomplishment of a specific task or tasks. Also called **TF**. See also **task organization**. (See page 5-34 for symbol.) See FM 1-02.

task organization – (DOD) 1. In the Navy, an organization which assigns to responsible commanders the means with which to accomplish their assigned tasks in any planned action. 2. An organization table pertaining to a specific naval directive. (Army) A temporary grouping of forces designed to accomplish a particular mission. (FM 3-0) (Marine Corps) In the Marine Corps, a temporary grouping of forces designed to accomplish a particular mission. Task organization involves the distribution of available assets to subordinate control headquarters by attachment or by placing assets in direct support or under the operational control of the subordinate.

task-organizing – (DOD) The act of designing an operating force, support staff, or logistics package of specific size and composition to meet a unique task or mission. Characteristics to examine when task-organizing the force include, but are not limited to: training, experience, equipment, sustainability, operating environment, enemy threat, and mobility. (Army) The process of allocating available assets to subordinate commanders and establishing their command and support relationships. (FM 3-0)

T-day – (DOD) The effective day coincident with Presidential declaration of national emergency and authorization of partial mobilization (not more than 1,000,000 personnel exclusive of the 200,000 callup). See also **times**. See FM 101-5.

technical intelligence – (DOD) Intelligence derived from exploitation of foreign material, produced for strategic, operational, and tactical level commanders. Technical intelligence begins when an individual service member finds something new on the battlefield and takes proper steps to report it. The item is then exploited at succeeding higher levels until a countermeasure is produced to neutralize the adversary's technological advantage. Also called **TECHINT**. See also **exploitation; intelligence; scientific and technical intelligence**. See FM 34-1.

techniques – (Army/Marine Corps) The general and detailed methods used by troops and/or commanders to perform assigned missions and functions, specifically, the methods of using equipment and personnel. (FM 3-90).

tempo – (Army) The rate of military action. (FM 3-0) (Marine Corps) The relative speed and rhythm of military operations over time with respect to the enemy.

terminal – (DOD) A facility designed to transfer cargo from one means of conveyance to another. (Conveyance is the piece of equipment used to transport cargo, i.e., railcar to truck or truck to truck. This is as opposed to mode, which is the type of equipment, i.e., ship to rail or rail to truck.) See FM 55-60.

terrain analysis – (DOD, NATO) The collection, analysis, evaluation, and interpretation of geographic information on the natural and manmade features of the terrain, combined with other relevant factors, to predict the effect of the terrain on military operations. See FM 34-130.

terrain flight – (DOD, NATO) Flight close to the Earth's surface during which airspeed, height, and/or altitude are adapted to the contours and cover of the ground in order to avoid enemy detection and fire. Also called **TERF**. See FM 3-04.111.

terrain following – Terrain flying that includes low-level, contour, and nap-of-the-earth flight techniques. (FM 3-04.111)

terrain management – The process of allocating terrain by establishing areas of operation, designating assembly areas, and specifying locations for units and activities to deconflict activities that might interfere with each other. It includes grouping units together to form bases, and designating a base cluster as necessary. (FM 3-0)

terrain reinforcement – The development of terrain using obstacles to degrade enemy mobility or to enhance friendly survivability through the construction of fighting positions and cover. See also **countermobility operations; survivability operations**. (FM 5-100)

terrorism – (DOD) The calculated use of unlawful violence or threat of unlawful violence to inculcate fear; intended to coerce or to intimidate governments or societies in the pursuit of goals that are generally political, religious, or ideological. See also **antiterrorism**; **counterterrorism**.

terrorist – (DOD) An individual who uses violence, terror, and intimidation to achieve a result. See also **terrorism**.

theater – (DOD) The geographical area outside the continental United States for which a commander of a combatant command has been assigned responsibility. See FM 3-0.

theater airlift – See **intratheater airlift**.

theater distribution – (DOD) The flow of personnel, equipment and materiel within theater to meet the geographic combatant commander's missions. See also **distribution**; **theater**; **theater distribution system**. See FM 100-10-1.

theater distribution management – (DOD) The function of optimizing the distribution networks to achieve the effective and efficient flow of personnel, equipment, and materiel to meet the combatant commander's requirements. See also **distribution**; **theater**; **theater distribution**. See FM 100-10-1.

theater distribution system – (DOD) A distribution system comprised of four independent and mutually supported networks within theater to meet the geographic combatant commander's requirements: the physical network; the financial network; the information network; and the communications network. See also **distribution**; **distribution plan**; **distribution system**; **theater**; **theater distribution**. See FM 100-10-1.

theater missile – (DOD) A missile, which may be a ballistic missile, a cruise missile, or an air-to-surface missile (not including short-range, non-nuclear, direct-fire missiles, bombs, or rockets such as Maverick or wire-guided missiles), whose target is within a given theater of operation. Also called **TM**. See FM 100-12.

theater missile defense – Applies to the identification, integration, and employment of forces, supported by other theater and national capabilities, to detect, identify, locate, track, minimize the effects of, or destroy enemy theater missiles (TM). This includes the destruction of TMs on the ground and in flight; their ground-based launchers and supporting infrastructure; TM-capable ships and vessels in port or at sea; and enemy aircraft armed with air-to-surface missiles. Theater missile defense comprises four pillars necessary for a complete TM defense: passive defense; active defense; attack operations; and command, control, communications, computers and intelligence (C4I) measures. Also called **TMD**. See also **active defense**; **attack operations**; **passive defense**. (FM 100-12) (See page 5-6 for symbol.)

theater missile defense system – Applies to a system or systems with applicable capabilities that may be used to support passive defense measures; active defense measures; attack operations capabilities; and the command, control, communications, computers and intelligence and countermeasures required to counter the missile threat. (FM 100-12)

theme – A subject, topic, or line of persuasion used to achieve a psychological objective. (FM 3-05.30)

thermal radiation – (DOD, NATO) 1. The heat and light produced by nuclear explosion. 2. (DOD only) Electromagnetic radiations emitted from a heat or light source as a consequence of its temperature; it consists essentially of ultraviolet, visible, and infrared radiations. See FM 100-30.

this is – A procedure word meaning, “This transmission is from the station whose designator immediately follows.” See also **procedure word**. (FM 24-19)

thorough decontamination – (DOD) Decontamination carried out by a unit, with or without external support, to reduce contamination on personnel, equipment, materiel, and/or working areas equal to natural background or to the lowest possible levels, to permit the partial or total removal of individual protective equipment, and to maintain operations with minimum degradation. This may include terrain decontamination beyond the scope of operational decontamination. See also **decontamination; immediate decontamination; operational decontamination**. See FM 3-5.

threatened species – Those species that are likely to become endangered within the foreseeable future throughout all or a significant portion of their range. See also **endangered species**. (FM 3-100.4)

throughput – (DOD) The average quantity of cargo and passengers that can pass through a port on a daily basis from arrival at the port to loading onto a ship or plane, or from the discharge from a ship or plane to the exit (clearance) from the port complex. Throughput is usually expressed in measurement tons, short tons, or passengers. Reception and storage limitation may affect final throughput. (Army/Marine Corps) In logistics, the flow of sustainability assets in support of military operations, at all levels of war, from point of origin to point of use. It involves the movement of personnel and materiel over lines of communications using established pipelines and distribution systems. (FM 4-0)

throughput distribution – The bypassing of one or more intermediate supply echelons in the supply system to avoid multiple handling. (FM 4-0)

time – A procedure word meaning, “That which immediately follows is the time or date/time group of the message.” See also **procedure word**. (FM 24-19)

time of attack – (DOD) The hour at which the attack is to be launched. If a line of departure is prescribed, it is the hour at which the line is to be crossed by the leading elements of the attack. (Army) The moment the leading elements of the main body cross the line of departure or, in a night attack, the point of departure. See also **H-hour**. (FM 3-90)

time of flight – (DOD, NATO) In artillery, mortar, and naval gunfire support, the time in seconds from the instant a weapon is fired, launched, or released from the delivery vehicle or weapons system to the instant it strikes or detonates. See FM 6-30.

time on target – (DOD) 1. Time at which aircraft are scheduled to attack/photograph the target. See FM 3-04.111. 2. The actual time at which aircraft attack/photograph the target. See FM 3-04.111. 3. The time at which a nuclear detonation is planned at a specific desired ground zero. See FM 100-30. (Marine Corps) The local time, expressed in minutes after the hour, when the forward air controller desires ordnance impact on target. Also called **TOT**.

time-phased force and deployment data – (DOD) The Joint Operation Planning and Execution System database portion of an operation plan; it contains time-phased force data, non-unit-related cargo and personnel data, and movement data for the operation plan,

including the following: a. In-place units; b. Units to be deployed to support the operation plan with a priority indicating the desired sequence for their arrival at the port of debarkation; c. Routing of forces to be deployed; d. Movement data associated with deploying forces; e. Estimates of non-unit related cargo and personnel movements to be conducted concurrently with the deployment of forces; and f. Estimate of transportation requirements that must be fulfilled by common-user lift resources as well as those requirements that can be fulfilled by assigned or attached transportation resources. Also called **TPFDD**. See also **time-phased force and deployment list**. See FM 100-7.

time-phased force and deployment list – (DOD) Appendix 1 to Appendix A of the operation plan. It identifies types and/or actual units required to support the operation plan and indicates origin and ports of debarkation or ocean area. It may also be generated as a computer listing from the time-phased force and deployment data. Also called **TPFDL**. See also **Joint Operation Planning and Execution System; time-phased force and deployment data**. See FM 100-7.

times – (DOD) (C-, D-, M-days end at 2400 hours Universal Time (Zulu time) and are assumed to be 24 hours long for planning.) The Chairman of the Joint Chiefs of Staff normally coordinates the proposed date with the commanders of the appropriate unified and specified commands, as well as any recommended changes to C-day. L-hour will be established per plan, crisis, or theater of operations and will apply to both air and surface movements. Normally, L-hour will be established to allow C-day to be a 24-hour day. a. **C-day**. The unnamed day on which a deployment operation commences or is to commence. The deployment may be movement of troops, cargo, weapon systems, or a combination of these elements using any or all types of transport. The letter "C" will be the only one used to denote the above. The highest command or headquarters responsible for coordinating the planning will specify the exact meaning of C-day within the aforementioned definition. The command or headquarters directly responsible for the execution of the operation, if other than the one coordinating the planning, will do so in light of the meaning specified by the highest command or headquarters coordinating the planning. b. **D-day**. The unnamed day on which a particular operation commences or is to commence. c. **F-hour**. The effective time of announcement by the Secretary of Defense to the Military Departments of a decision to mobilize Reserve units. d. **H-hour**. The specific hour on D-day at which a particular operation commences. e. **H-hour (amphibious operations)**. For amphibious operations, the time the first assault elements are scheduled to touch down on the beach, or a landing zone, and in some cases the commencement of countermine breaching operations. f. **L-hour**. The specific hour on C-day at which a deployment operation commences or is to commence. g. **L-hour (amphibious operations)**. In amphibious operations, the time at which the first helicopter of the helicopter-borne assault wave touches down in the landing zone. h. **M-day**. The term used to designate the unnamed day on which full mobilization commences or is due to commence. i. **N-day**. The unnamed day an active duty unit is notified for deployment or redeployment. j. **R-day**. Redeployment day. The day on which redeployment of major combat, combat support, and combat service support forces begins in an operation. k. **S-day**. The day the President authorizes Selective Reserve callup (not more than 200,000). l. **T-day**. The effective day coincident with Presidential declaration of national emergency and authorization of partial mobilization (not more than 1,000,000 personnel exclusive of the 200,000 callup). m. **W-day**. Declared by the National Command Authorities, W-day is associated with an adversary decision to prepare for war (unambiguous strategic warning). See FM 101-5.

to – A procedure word meaning, “The addressee(s) immediately following is (are) addressed for action.” See also **procedure word**. (FM 24-19)

tolerance dose (DOD) – The amount of radiation that may be received by an individual within a specified period with negligible results. See FM 3-3-1.

topographical crest – Highest point on a hill, ridge, or mountain. See also **military crest**. (FM 3-25.26)

topographic map – (DOD) A map that presents the vertical position of features in measurable form as well as their horizontal position. See also **map**. See FM 3-25.26.

total asset visibility – (DOD) The capability to provide users with timely and accurate information on the location, movement, status, and identity of units, personnel, equipment, materiel, and supplies. It also includes the capability to act upon that information and to improve overall performance of the Department of Defense logistic practices. (Army) The capability for both operational and logistics managers to obtain and act on information on the location, quantity, condition, movement, and status of assets throughout DOD's logistics system. Total asset visibility includes all levels and all secondary items, both consumable and reparable. (FM 4-0) (Marine Corps) The ability to access on demand the status and location of any required materiel. Also called **TAV**. See also **in-transit visibility**.

total mobilization – (DOD) Expansion of the active Armed Forces resulting from action by Congress and the President to organize and/or generate additional units or personnel beyond the existing force structure, and the resources needed for their support, to meet the total requirements for war or other national emergency involving an external threat to the national security. See also **mobilization**. See FM 100-17.

toxic – Capable of producing illness, injury, or damage to humans, domestic livestock, wildlife, or other organisms through ingestion, inhalation, or absorption through any body surface. (FM 3-100.4)

toxic industrial biological – Biological materials (bacteria, viruses, and toxins) found in medical research, pharmaceutical, and other manufacturing processes that are toxic to humans and animals or cause damage to plants. Also called **TIB**. (FM 4-02.7)

toxic industrial chemical – Chemical compounds used or produced in industrial processes that are toxic to humans and animals or cause damage to plants. Also called **TIC**. (FM 4-02.7)

toxic industrial hazard – The hazards resulting from the release, by any means, of toxic industrial materials, resulting in contamination or irradiation of personnel or the environment area or any particular object. Also called **TIH**. (FM 3-100.4)

toxic industrial material – A generic term for toxic radioactive compounds in solid, liquid, aerosolized or gaseous form. These may be used, or stored for use, for industrial, commercial, medical, military, or domestic purposes. Toxic industrial materials may be chemical, biological, or radioactive and described as toxic industrial chemical (TIC), toxic industrial biological (TIB), or toxic industrial radiological (TIR). Also called **TIM**. (FM 3-19)

toxic industrial radiological – Radiation-emitting materials used in research, power generation, medical treatment, and other nonweapon developmental activities that are harmful to humans and animals if released outside their controlled environment. Also called **TIR**. (FM 4-02.7)

toxicity – One of the four possible characteristics of hazardous waste as defined by the Environmental Protection Agency. It is the ability to release certain toxic constituents when leached with mild acid. (FM 3-100.4)

toxin agent – (DOD) A poison formed as a specific secretion product in the metabolism of a vegetable or animal organism as distinguished from inorganic poisons. Such poisons can also be manufactured by synthetic processes. See FM 8-284.

track – (DOD) 1. A series of related contacts displayed on a data display console or other display devices. See FM 44-100. 2. To display or record the successive positions of a moving object. See FM 44-100. 3. To lock onto a point of radiation and obtain guidance therefrom. See FM 44-100. 4. To keep a gun properly aimed, or to point continuously a target-locating instrument at a moving target. 5. The actual path of an aircraft above, or a ship on, the surface of the Earth. The course is the path that is planned; the track is the path that is actually taken. See FM 3-04.111. 6. One of two endless belts on which a full-track or half-track vehicle runs. 7. A metal part forming a path for a moving object, e.g., the track around the inside of a vehicle for moving a mounted machine gun.

tracking – (NATO) Precise and continuous position-finding of targets by radar, optical, and other means. See FM 44-100.

track telling – (DOD, NATO) The process of communicating air surveillance and tactical data information between command and control systems or between facilities within the systems. Telling may be classified into the following types: back tell; cross tell; forward tell; lateral tell; overlap tell; and relateral tell. [Note: the NATO definition defines each type as follows: a. **back tell**—the transfer of information from a higher to a lower echelon of command; b. **cross tell**—the transfer of information between facilities at the same operational level; c. **forward tell**—the transfer of information to a higher level of command; d. **overlap tell**—the transfer of information to an adjacent facility concerning tracks detected in the adjacent facility's area of responsibility; e. **relateral tell**—the relay of information between facilities through a third facility. This type of telling is appropriate between automated facilities in a degraded communication environment.”]

trafficability – (DOD, NATO) Capability of terrain to bear traffic. It refers to the extent to which the terrain will permit continued movement of any or all types of traffic. See FM 34-130.

traffic control post – Manned post used to preclude interruption of traffic flow or movement along designated routes. They are used to support maneuver and mobility support operations only when needed. Also called **TCP**. (FM 3-19.4) (See page 7-64 for symbol.)

trailer transfer point – A location where trailers are transferred from one carrier to another while en route. See also **logistics release point**. (FM 55-30) (See page 7-64 for symbol.)

trail party – The last march unit in a march serial, usually consisting of priority maintenance and recovery vehicles. See also **unit maintenance collection point**. (FM 63-2)

train – (DOD) 1. A service force or group of service elements that provides logistic support, e.g., an organization of naval auxiliary ships or merchant ships attached to a fleet for this purpose; similarly, the vehicles and operating personnel which furnish supply, evacuation and maintenance services to a land unit. See FM 4-0. 2. Bombs dropped in short interval or sequence. See FM 3-04.111. See also **combat trains**; **field trains**; **unit trains**.

transmission security – (DOD) The component of communications security that results from all measures designed to protect transmissions from interception and exploitation by means other than cryptanalysis. See also **communications security**. See FM 34-1.

transportation – A combat service support function: moving and transferring units, personnel, equipment, and supplies to support the concept of operations. Transportation incorporates military, commercial, and multinational capabilities. Transportation assets include motor, rail, air, and water modes and units; terminal units, activities, and infrastructure; and movement control units and activities. (FM 4-0)

traveling – A movement technique used when speed is necessary and contact with enemy forces is not likely. All elements of the unit move simultaneously with the unit leader located where he can best control his unit. (FM 3-90)

traveling overwatch – (Army/Marine Corps) A movement technique used when contact with enemy forces is possible. The lead element and trailing element are separated by a short distance which varies with the terrain. The trailing element moves at variable speeds and may pause for short periods to overwatch the lead element. It keys its movement to terrain and the lead element. The trailing element overwatches at such a distance that, should the enemy engage the lead element, it will not prevent the trailing element from firing or moving to support the lead element. (FM 3-90).

triage – (NATO) 1. The evaluation and classification of wounded for purposes of treatment and evacuation. It consists of the immediate sorting of patients according to type and seriousness of injury, and likelihood of survival, and the establishment of priority for treatment and evacuation to assure medical care of the greatest benefit to the largest number. See FM 4-02. 2. In battlefield maintenance, the classification of equipment by a maintenance unit for further action. See FM 4.30.3. Also called **sorting**.

trigger – 1. Event- or time-oriented criteria used to initiate planned actions directed toward achieving surprise and inflicting maximum destruction on the enemy. 2. A designated point or points (selected along identifiable terrain) in an engagement area used to mass fires at a predetermined range. (FM 6-30)

trigger line – A phase line—located on identifiable terrain that crosses the engagement area—used to initiate and mass fires into an engagement area at a predetermined range for all or like weapon systems. (FM 3-90)

troop movement – The movement of troops from one place to another by any available means. (FM 3-90)

true azimuth – Direction measured as an angle to the east of the north star (Polaris). See also **azimuth**. (FM 3-25.26)

true north – (DOD, NATO) The direction from an observer's position to the geographic North Pole. The north direction of any geographic meridian. See FM 3-25.26.

turn – 1. A tactical mission task that involves forcing an enemy force from one avenue of approach or movement corridor to another. 2. A tactical obstacle effect that integrates fire planning and obstacle effort to drive an enemy formation from one avenue of approach to an adjacent avenue of approach or into an engagement area. (FM 3-90) (See pages 7-49 and A-6 for symbol.)

turnaround – (DOD, NATO) The length of time between arriving at a point and being ready to depart from that point. It is used in this sense for the loading, unloading, refueling, and rearming, where appropriate, of vehicles, aircraft, and ships. See FM 55-30.

turning movement – (DOD, NATO) A variation of the envelopment in which the attacking force passes around or over the enemy's principal defensive positions to secure objectives deep in the enemy's rear to force the enemy to abandon his position or divert major forces to meet the threat. (Army) A form of maneuver in which the attacking force seeks to avoid the enemy's principal defensive positions by seizing objectives to the enemy rear and causing the enemy to move out of his current positions or divert major forces to meet the threat. See also **forms of maneuver**. (FM 3-0)

turning point – (DOD, NATO) In land mine warfare, a point on the centerline of a mine strip or row where it changes direction. See FM 20-32.

turret down – Fighting position in which the entire vehicle is behind cover, but the commander can still observe to the front from the turret hatch or cupola. See also **hide**; **hull down**. (FM 3-20.15)

twilight – The period of incomplete darkness following sunset and preceding sunrise. Twilight is designated as civil, nautical, or astronomical, as the darker limit occurs when the center of the sun is 6, 12, or 18 degrees, respectively, below the celestial horizon. See also **begin morning civil twilight**; **begin morning nautical twilight**; **end evening civil twilight**; **end of evening nautical twilight**. (FM 34-130)

—U—

unanticipated immediate target – (DOD) Those immediate targets that are unknown or not expected to exist in an operational area. See also **immediate target(s)**; **operational area**; **target**; **unplanned immediate target**. See FM 6-20-40.

uncertain environment – (DOD) Operational environment in which host government forces, whether opposed or receptive to operations that a unit intends to conduct, do not have totally effective control of the territory and population in the intended operational area. See also **operational environment**. See FM 3-07.

uncommitted force – A force that is not in contact with an enemy and is not already assigned a specific mission or course of action which would preclude its use elsewhere. (FM 3-90)

unconventional warfare – (DOD) A broad spectrum of military and paramilitary operations, normally of long duration, predominantly conducted by indigenous or surrogate forces who are organized, trained, equipped, supported, and directed in varying degrees by an external source. It includes guerrilla warfare and other direct offensive, low visibility, covert, or clandestine operations, as well as the indirect activities of subversion, sabotage, intelligence activities, and evasion and escape. Also called **UW**. See also **military operations other than war**. See FM 3-05.201.

underground – A covert unconventional warfare organization established to operate in areas denied to the guerrilla forces or conduct operations not suitable for guerrilla forces. (FM 3-05.20)

understanding – In the context of the cognitive hierarchy, knowledge that has been synthesized and had judgment applied to it in a specific situation to comprehend the situation's inner relationships. (FM 6-0)

unexploded explosive ordnance – (DOD, NATO) Explosive ordnance which has been primed, fused, armed, or otherwise prepared for action, and which has been fired, dropped, launched, projected, or placed in such a manner as to constitute a hazard to operations, installations, personnel, or material, and remains unexploded either by malfunction or design or for any other cause. Also called **UXO**. See FM 21-16.

unified action – (DOD) A broad generic term that describes the wide scope of actions (including the synchronization of activities with governmental and nongovernmental agencies) taking place within unified commands, subordinate unified commands, or joint task forces under the overall direction of the commanders of those commands. See FM 3-0.

unified combatant command – See also **unified command**.

unified command – (DOD) A command with a broad continuing mission under a single commander and composed of significant assigned components of two or more Military Departments, that is established and so designated by the President through the Secretary of Defense with the advice and assistance of the Chairman of the Joint Chiefs of Staff. Also called **unified combatant command**. See also **combatant command**. See FM 100-7.

unit – (DOD, NATO) 1. Any military element whose structure is prescribed by competent authority, such as a table of organization and equipment; specifically, part of an organization. [Note: the NATO definition does not include “such as a table of organization and equipment; specifically part of an organization.”] 2. A standard or basic quantity into which an item of supply is divided, issued, and used. [Note: the NATO definition ends here.] In this meaning, also called **unit of issue**. 3. (DOD only) An organization title of a subdivision of a group in a task force. 4. With regard to Reserve Components of the Armed Forces, denotes a Selected Reserve unit organized, equipped, and trained for mobilization to serve on active duty as a unit or to augment or be augmented by another unit. Headquarters and support functions without wartime missions are not considered units. (See page B-1 for symbols.)

unit configured load – Load built to the known requirements of a consuming unit. These loads are normally built in the corps area of operations to be delivered directly to the consuming unit. Also called **UCL**. (FM 4-0).

unit distribution – A method of distributing supplies by which the receiving unit is issued supplies in its own area, with transportation furnished by the issuing agency. (FM 10-1)

unit maintenance collection point – A location or series of locations, operated by a battalion maintenance platoon, that is the nearest point to the combat unit to which equipment can be recovered, and where limited parts are available, and some repairs can be performed. Also called **UMCP**. (FM 4-30.3) (See page 7-65 for symbol.)

unit trains – Combat service support personnel and equipment organic or attached to a force that provides support such as supply, evacuation, and maintenance services. Unit trains, whether or not echeloned, are under unit control and no portion of them is released to the control of a higher headquarters. Trains are normally echeloned into combat and field trains. See also **combat trains**; **field trains**. (FM 4-0)

unity of command – One of the nine principles of war: For every objective, ensure unity of effort under one responsible commander. See also **principles of war**. (FM 3-0)

unity of effort – Coordination and cooperation among all forces toward a commonly recognized objective, even if the forces are not necessarily part of the same command structure. (FM 6-0)

Universal Time (DOD) – A measure of time that conforms, within a close approximation, to the mean diurnal rotation of the Earth and serves as the basis of civil timekeeping. Universal Time (UT1) is determined from observations of the stars, radio sources, and also from ranging observations of the moon and artificial Earth satellites. The scale determined directly from such observations is designated Universal Time Observed (UTO); it is slightly dependent on the place of observation. When UTO is corrected for the shift in longitude of the observing station caused by polar motion, the time scale UT1 is obtained. When an accuracy better than one second is not required, Universal Time can be used to mean Coordinated Universal Time (UTC). Formerly called **Greenwich Mean Time**. Also called **ZULU time**. See FM 101-5.

universal transverse mercator grid – (DOD, NATO) A grid coordinate system based on the transverse mercator projection, applied to maps of the Earth's surface extending to 84 degrees N and 80 degrees S latitudes. Also called **UTM grid**. See FM 3-25.26.

unknown – (DOD) 1. A code meaning "information not available." 2. An unidentified target. An aircraft or ship that has not been determined to be hostile, friendly, or neutral using identification friend or foe and other techniques, but that must be tracked by air defense or naval engagement systems. See FM 44-100. 3. An identity applied to an evaluated track that has not been identified. See also **friendly**; **hostile**; **neutral**; **suspect**. See FM 44-100. (See page 4-3 for symbol.)

unknown station – A procedure word meaning, "The identity of the station with whom I am attempting to establish communications is unknown." See also **procedure word**. (FM 24-19)

unobserved fire – (NATO) Fire for which the points of impact or burst are not observed. See FM 6-30.

unplanned immediate target – (DOD) Those immediate targets that are known to exist but are not detected, located, or selected for action in sufficient time to be included in the normal targeting process. See also **immediate target(s)**; **operational area**; **target**; **unanticipated immediate target**. See FM 6-20-40.

unwarned exposed – (DOD, NATO) The vulnerability of friendly forces to nuclear weapon effects. In this condition, personnel are assumed to be standing in the open at burst time, but have dropped to prone position by the time the blast wave arrives. They are expected to have areas of bare skin exposed to direct thermal radiation, and some personnel may suffer dazzle. See also **warned exposed**; **warned protected**. See FM 100-30.

unwitting actor – An individual participating in the conduct of military deception operations without personal knowledge of the facts of the deception. (FM 3-13)

up – (NATO) In artillery and naval fire support: a. A term used in a call for fire to indicate that the target is higher in altitude than the point which has been used as a reference point for the target location. b. A correction used by an observer or a spotter in time fire to indicate that an increase in height of burst is desired. [Note: the Army definition also applies to

mortar fire.] (Army) Indirect fire, a term used to move the point of aim higher than the previous point of aim, usually expressed in mils. (FM 6-30)

urban area – A topographical complex where manmade construction or high population density is the dominant feature. (FM 3-06)

urban environment – Includes the physical urban area and the complex and dynamic interaction among its key components—the terrain (natural and manmade), the population, and the supporting infrastructure—as an overlapping and interdependent system of systems. Effects of this interaction may extend well into surrounding rural areas, as well as significantly influence smaller neighboring urban areas. Critical elements of the infrastructure may well lie outside the area’s physical confines. (FM 3-06)

urban operations – Offense, defense, stability, and support operations conducted in a topographical complex and adjacent natural terrain where manmade construction and high population density are the dominant features. (FM 3-0)

—V—

V-agents – Persistent, highly toxic nerve agents absorbed primarily through the skin. (FM 3-9)

variances – Differences between the actual situation during an operation and what the plan forecasted the situation would be at that time or event. (FM 6-0)

vee formation – A unit formation with subordinate elements arranged in a V formation with the point facing away from the templated enemy. This formation is hard to reorient and difficult to control in heavily wooded areas but provides good firepower to the front and flanks. See also **formation**; **movement formation**; **wedge formation**. (FM 3-90)

vehicle distance – (DOD, NATO) The clearance between vehicles in a column which is measured from the rear of one vehicle to the front of the following vehicle. See also **march column**; **march serial**; **march unit**. See FM 55-30.

vehicle washdown – Technique used for flushing contamination off equipment surfaces to limit the spreading and transferring of contamination. Along with mission-oriented protective posture gear exchange, it is part of decontamination operations. (FM 3-5)

verify – A procedure word meaning, “Verify entire message (or portion indicated) with the originator and send correct version.” (To be used only at the discretion of the addressee to which question message was directed.) See also **procedure word**. (FM 24-19)

versatility – The ability of Army forces to meet the global, diverse mission requirements of full spectrum operations. (FM 3-0)

vertical envelopment – (DOD) A tactical maneuver in which troops, either air-dropped or air-landed, attack the rear and flanks of a force, in effect cutting off or encircling the force. See also **air assault**; **envelopment**. See FM 90-4.

vesicant agent – See **blister agent**.

viral agents – A group of viruses that have been selected as biological warfare agents because of their ability to produce disease, illness, and death in susceptible individuals. (FM 8-284)

visual flight rules – A meteorological condition that allows pilots to control aircraft orientation and attitude using visual references (the ground and natural horizon). When weather conditions are good enough to allow pilots to safely operate their aircraft without the control requirements of instrument flight rules flight procedures, and weather minimum conditions are above the regulatory requirements for visual flight rules (VFR) flight, pilots may operate under VFR procedures. Also called **VFR**. (FM 3-04.111)

visualize – To create and think in mental images. (FM 6-0)

vulnerability – (DOD) 1. The susceptibility of a nation or military force to any action by any means through which its war potential or combat effectiveness may be reduced or its will to fight diminished. 2. The characteristics of a system that cause it to suffer a definite degradation (incapability to perform the designated mission) as a result of having been subjected to a certain level of effects in an unnatural (manmade) hostile environment. 3. In information operations, a weakness in information system security design, procedures, implementation, or internal controls that could be exploited to gain unauthorized access to information or an information system. See FM 3-13. (Army) Manifestation of an unsatisfied or perceived need in an individual or a target audience. (FM 3-05.30).

vulnerability analysis – (DOD) In information operations, a systematic examination of an information system or product to determine the adequacy of security measures, identify security deficiencies, provide data from which to predict the effectiveness of proposed security measures, and confirm the adequacy of such measures after implementation. See FM 3-13. (Army) A process to determine which friendly elements are within the radius of vulnerability for a proposed friendly weapon of mass destruction target and whether they will be exposed to a radiation risk greater than emergency risk. See also **emergency risk; information operations; information system; radius of vulnerability; security; troop safety; vulnerability**. (FM 3-3-1)

—W—

wait – A procedure word meaning, “I must pause for a few seconds.” See also **procedure word**. (FM 24-19)

waiting area – A location adjacent to the route or axis that may be used for the concealment of vehicles, troops, and equipment while an element is waiting to resume movement. Waiting areas are normally located on both banks close to crossing areas. (FM 90-13)

wait out – A procedure word meaning, “I must wait for longer than a few seconds.” See also **procedure word**. (FM 24-19)

walking patient – (DOD) A patient whose injuries and/or illness are relatively minor, permitting the patient to walk and not require a litter. (NATO) A patient not requiring litter while in transit. See also **casualty; patient**. See FM 4-02.

war game – (DOD) A simulation, by whatever means, of a military operation involving two or more opposing forces, using rules, data, and procedures designed to depict an actual or assumed real life situation. [Note: see AAP-6.] See FM 101-5.

wargaming – A step-by-step process of action, reaction, and counteraction for visualizing the execution of each friendly course of action (COA) in relation to enemy COAs and reactions. It explores the possible branches and sequels to the primary plan resulting in a final plan and decision points for critical actions. See also **commander’s visualization**. (FM 101-5)

warned exposed – (DOD, NATO) The vulnerability of friendly forces to nuclear weapon effects. In this condition, personnel are assumed to be prone with all skin covered and with thermal protection, at least that provided by a two-layer summer uniform. See also **unwarned exposed**; **warned protected**. See FM 100-30.

warned protected – (DOD, NATO) The vulnerability of friendly forces to nuclear weapon effects. In this condition, personnel are assumed to have some protection against heat, blast, and radiation such as that afforded in enclosed armored vehicles or crouched in fox holes with improvised overhead shielding. See also **unwarned exposed**; **warned exposed**. See FM 100-30.

warning order – (DOD, NATO) 1. A preliminary notice of an order or action which is to follow. 2. (DOD only) A crisis action planning directive issued by the Chairman of the Joint Chiefs of Staff that initiates the development and evaluation of courses of action by a supported commander and requests that a commander's estimate be submitted. 3. A planning directive that describes the situation, allocates forces and resources, establishes command relationships, provides other initial planning guidance, and initiates subordinate unit mission planning. Also called **WARNO**. See FM 101-5.

waste – Any discarded material. See also **hazardous waste**; **medical waste**; **solid waste**. (FM 3-100.4)

water terminal (DOD) – A facility for berthing ships simultaneously at piers, quays, and/or working anchorages, normally located within sheltered coastal waters adjacent to rail, highway, air, and/or inland water transportation networks. See FM 55-60.

wave – (DOD, NATO) 1. A formation of forces, landing ships, craft, amphibious vehicles, or aircraft required to beach or land about the same time. [Note: the NATO definition begins with "In amphibious operations."] Can be classified as to type, function, or order as shown: a. assault wave; b. boat wave; c. helicopter wave; d. numbered wave; e. on-call wave; f. scheduled wave. 2. (DOD only) An undulation of water caused by the progressive movement of energy from point to point along the surface of the water.

way point – (DOD) 1. In air operations, a point or a series of points in space to which an aircraft, ship, or cruise missile may be vectored. See FM 3-04.111. 2. A designated point or series of points loaded and stored in a global positioning system or other electronic navigational aid system to facilitate movement. See FM 3-25.26. (See page 7-44 for symbol.)

W-day – (DOD) Declared by the President and the Secretary of Defense or their duly deputized alternates or successors, W-day is associated with an adversary decision to prepare for war (unambiguous strategic warning). See also **times**. See FM 101-5.

weapon control status – Weapon control statuses (weapons free, weapons tight, weapons hold) describe the relative degree of control of air defense fires. Weapon control statuses apply to weapon systems, volumes of airspace, or types of air platforms. The degree or extent of control varies depending on the tactical situation. **Weapons Free**—Weapons can fire at any air target not positively identified as friendly. This is the least restrictive weapon control status. **Weapons Tight**—Fire only at air targets that are identified as hostile according to the prevailing hostile criteria. Identification can be effected by a number of means to include visual identification (aided or unaided), electronic, or procedural means. Capabilities dictate that air defense artillery units engage threatening ballistic missiles and ASMs based on classification, not identification. **Weapons Hold**—Do not fire except in self-defense or in

response to a formal order. This is the most restrictive weapon control status. [Note: see AAP-6.] (FM 44-100)

weapon engagement zone – (DOD) In air defense, airspace of defined dimensions within which the responsibility for engagement of air threats normally rests with a particular weapon system. Also called **WEZ**. a. **fighter engagement zone**. In air defense, that airspace of defined dimensions within which the responsibility for engagement of air threats normally rests with fighter aircraft. Also called **FEZ**. b. **high-altitude missile engagement zone**. In air defense, that airspace of defined dimensions within which the responsibility for engagement of air threats normally rests with high-altitude surface-to-air missiles. Also called **HIMEZ**. c. **low-altitude missile engagement zone**. In air defense, that airspace of defined dimensions within which the responsibility for engagement of air threats normally rests with low- to medium-altitude surface-to-air missiles. Also called **LOMEZ**. d. **short-range air defense engagement zone**. In air defense, that airspace of defined dimensions within which the responsibility for engagement of air threats normally rests with short-range air defense weapons. It may be established within a low- or high-altitude missile engagement zone. Also called **SHORADEZ**. e. **joint engagement zone**. In air defense, that airspace of defined dimensions within which multiple air defense systems (surface-to-air missiles and aircraft) are simultaneously employed to engage air threats. Also called **JEZ**. See FM 3-52.

weapons free zone – (DOD) An air defense zone established for the protection of key assets or facilities, other than air bases, where weapon systems may be fired at any target not positively recognized as friendly. See also **air defense weapon control status**. See FM 44-100. (See page 7-21 for symbol.)

weapons of mass destruction – (DOD) Weapons that are capable of a high order of destruction and/or of being used in such a manner as to destroy large numbers of people. Weapons of mass destruction can be high explosives or nuclear, biological, chemical, and radiological weapons, but exclude the means of transporting or propelling the weapon where such means is a separable and divisible part of the weapon. Also called **WMD**. See FM 3-11.21.

wedge formation – A unit formation with subordinate elements in a vee formation with the point toward the suspected or templated enemy positions. This facilitates control and transition to the assault (line formation). The wedge provides maximum firepower forward and good firepower to the flanks. See also **formation**; **vee formation**. (FM 3-90)

white propaganda – (DOD, NATO) Propaganda disseminated and acknowledged by the sponsor or by an accredited agency thereof. See also **black propaganda**; **grey propaganda**; **propaganda**. See FM 3-05.30.

wilco – A procedure word meaning, “I have received your signal, understand it, and will comply.” (To be used only by addressee. Since the meaning of ROGER is included in that of WILCO, the two procedure words are never used together.) See also **procedure word**. (FM 24-19)

withdrawal operation – (DOD, NATO) A planned retrograde operation in which a force in contact disengages from an enemy force and moves in a direction away from the enemy. [Note: see AAP-6.] See also **retrograde**. See FM 3-0.

witting actor – An individual participating in the conduct of a military deception operation who is fully aware of the facts of the deception. (FM 3-13)

word after – A procedure word meaning, "The word of the message to which I have reference is that which follows (insert text)." See also **procedure word**. (FM 24-19)

word before – A procedure word meaning, "The word of the message to which I have reference is that which precedes (insert text)." See also **procedure word**. (FM 24-19)

words twice – A procedure word meaning, "Communication is difficult. Transmit (ring) each phrase (or each code group) twice." This procedure word may be used as an order, request, or as information. See also **procedure word**. (FM 24-19)

world geographic reference system – See **georef**.

wounded in action – (DOD) A casualty category applicable to a hostile casualty, other than the victim of a terrorist activity, who has incurred an injury due to an external agent or cause. The term encompasses all kinds of wounds and other injuries incurred in action, whether there is a piercing of the body, as in a penetration or perforated wound, or none, as in the contused wound. These include fractures, burns, blast concussions, all effects of biological and chemical warfare agents, and the effects of an exposure to ionizing radiation or any other destructive weapon or agent. The hostile casualty's status may be categorized as "very seriously ill or injured," "seriously ill or injured," "incapacitating illness or injury," or "not seriously injured." Also called **WIA**. See FM 4-02.

wrong – A procedure word meaning, "Your last transmission was incorrect, the correct version is (insert text)." See also **procedure word**. (FM 24-19)

—X—

X-hour – The unspecified time that commences unit notification for planning and deployment preparation in support of potential contingency operations that do not involve rapid, no-notice deployment. (FM 101-5)

X-hour sequence – Extended sequence of events initiated by X-hour that allows a unit to focus on planning for a potential contingency operation, to include preparation for deployment. (FM 101-5)

—Z—

zone of fire – (DOD) An area into which a designated ground unit or fire support ship delivers, or is prepared to deliver, fire support. Fire may or may not be observed. (Army) Usually utilized during amphibious operations. The zone of fire is used to coordinate the efforts of the fire support ships and units with each other and with the ground scheme of maneuver. The size and location of a zone of fire is based on the ground force boundaries; the area in which the supporting ships and units can provide effective fire; visibility; range of the ship's guns; and the height of intervening terrain. See also **fire support area**; **fire support station**; **naval gunfire support**. (FM 6-20-30).

zone reconnaissance – A form of reconnaissance that involves a directed effort to obtain detailed information on all routes, obstacles, terrain, and enemy forces within a zone defined by boundaries. [Note: the Marine Corps definition adds: "A zone reconnaissance normally is assigned when the enemy situation is vague or when information concerning cross-country trafficability is desired."] See also **reconnaissance**. (FM 3-90)

ZULU Time – See **Universal Time**.

Chapter 2

Operational Acronyms, Abbreviations, and Country Codes

SECTION I – ACRONYMS AND ABBREVIATIONS

—A—

A2C2	Army airspace command and control
A/A	air-to-air
AA	assembly area; avenue of approach
AAA	antiaircraft artillery
AADC	area air defense commander
AAP	Allied Administrative Publication
AASLT	air assault
AATF	air assault task force
AATFC	air assault task force commander
AAW	antiair warfare
ABCA	America, Britain, Canada, and Australia [Armies Standardization Program]
ABCCC	airborne battlefield command and control center
ABCS	Army Battle Command System
ABE	assistant brigade engineer
abn	airborne
AC	active component
ACA	airspace control authority; airspace coordination area
ACE	air combat element (NATO); analysis and control element; armored combat earthmover; assistant corps engineer; aviation combat element (USMC)
ACERT	Army Computer Emergency Response Team
ACERT/CC	Army Computer Emergency Response Team/Coordination Center
acft	aircraft
ACL	allowable cabin load; allowable combat load
ACM	air contingency Marine air-ground task force; airspace control measures
ACO	airspace control order

ACOUSINT	acoustic intelligence
ACP	air control point
acq	acquisition
ACR	armored cavalry regiment
AC/RC	active component/reserve component
ACT	analysis and control team
AD	air defense; armored division
ADA	air defense artillery
ADC	area damage control; assistant division commander
ADC(M)	assistant division commander (maneuver)
ADC(S)	assistant division commander (support)
ADCON	administrative control
ADL	armistice demarcation line
ADM	atomic demolition munitions
admin	administrative
ADOA	air defense operations area
ADP	automated data process(ing)
ADSO	assistant division signal officer
ADT	active duty for training
ADW	air defense warning
AE	aeromedical evacuation
AELT	air evacuation liaison team
AEW&C	airborne early warning and control
AF	amphibious force
AFATDS	Advanced Field Artillery Tactical Data System
A/G	air to ground
AG	adjutant general
AGL	above ground level
AGM	advanced guided munitions; air-to-ground missile system
AI	air interdiction
AIM	air intercept missile
AIS	Army information systems
ALCE	airlift control element
ALO	air liaison officer; artillery liaison officer
alt	alternate; altitude
AM	amplitude modulation
AMB	air mission brief; air mobility branch
AMC	air mission commander

ammo	ammunition
ANZAC	Australia and New Zealand Corps
AO	area of operations
AOA	amphibious objective area
AOB	advanced operations/operational base
AOC	air operations center
AOI	area of interest
AOIR	area of intelligence responsibility
AOR	area of responsibility
AP	antipersonnel
APC	armored personnel carrier
APO	Army Post Office
APOD	aerial port of debarkation
APOE	aerial port of embarkation
APOINT	aerial port
APP	Allied Procedural Publication
AR	armor; Army regulation
ARAT-TA	Army Reprogramming Analysis Team-Threat Analysis
ARG	amphibious ready group
ARM	antiradiation missile
armd	armored
ARNG	Army National Guard
ARSOA	Army special operations aviation
ARSOF	Army special operations forces
ARSOTF	Army special operations task force
ARSPACE	Army Space Command
arty	artillery
A/S	air-to-surface
AS	area security
ASAS	All Source Analysis System
ASCC	Army service component commander
ASCM	antiship cruise missile
ASF	aeromedical staging facility
ASG	area support group
ASL	above sea level; allowable supply list; authorized stockage list
aslt	assault
ASLT PSN	assault position (graphics)
ASM	antiship missile

ASOC	air support operations center
ASP	ammunition supply point
ASR	alternate supply route; ammunition supply rate
ASW	antisubmarine warfare
AT	antitank; antiterrorism
ATACMS	Army Tactical Missile System
ATC	air traffic control
ATF	amphibious task force
atk	attack
ATK PSN	attack position (graphics)
ATLS	advance trauma life support
ATM	air tasking message
ATO	air tasking order
ATP	Allied Tactical Publication; ammunition transfer point
ATS	air traffic service
ATSS	Army Target Sensing System
AUTL	Army Universal Task List
AVIM	aviation intermediate maintenance
AVLB	armored vehicle-launched bridge
AVLM	armored vehicle-launched mine clearing
AVLO	aviation liaison officer
avn	aviation
AWACS	Airborne Warning and Control System
AXP	ambulance exchange point

—B—

B	biological (graphics)
BAS	battalion aid station
BCAT	base camp assistance/assessment team
BCD	battlefield coordination detachment
BCOC	base camp operations center; base cluster operations center
BCTP	battle command training program
BDA	battle damage assessment
bde	brigade
BDOC	base defense operations center
BDR	battle damage repair
BDU	battle dress uniform
BDZ	base defense zone
BF	battle fatigue; beginning of radioactive fallout

BFV	Bradley fighting vehicle
BG	brigadier general
BHL	battle handover line
BICC	battlefield information coordination center
biol	biological
BMCT	begin morning civil twilight
BMNT	begin morning nautical twilight
bn	battalion
BOM	bill of materials
BOS	battlefield operating systems
BP	battle position
BPAD	broadcast public affairs detachment
B/P	be-prepared mission
BRAA	bearing, range, altitude, aspect
BSA	brigade support area
btry	battery
BVR	beyond visual range
BZ	buffer zone
—C—	
C	chemical (graphics); cover
C2	command and control
C3CM	command, control, and communications countermeasures
C4ISR	command, control, communications, computers, intelligence, surveillance, and reconnaissance
CA	civil administration; civil affairs; combat assessment
cal	caliber
CALFEX	combined arms live fire exercise
CALL	Center for Army Lessons Learned
CAP	combat air patrol; crisis action planning
CARP	computed air release point
CARS	combat arms regimental system
cas	casualty
CAS	close air support
CASEVAC	casualty evacuation.
CATF	commander, amphibious task force
CATK	counterattack (graphics)
cav	cavalry
CBMU	construction battalion maintenance unit

CBRN	chemical, biological, radiological, and nuclear
CBRNE	chemical, biological, radiological, nuclear, and high yield explosives
cbt	combat
CBT	combatting terrorism
CCD	camouflage, concealment, and deception
CCIR	commander's critical information requirements
CCL	combat-configured load
CCP	casualty collection point; communications checkpoint
CCT	combat control team
CD	cavalry division; chemical defense; counterdrug
CDAP	computer defense assessment program
CDM	chemical downwind message
CDS	container delivery system
CE	command element; communications electronics
CEP	circular error probable
CERT	Computer Emergency Response Team
CEWI	combat electronic warfare and intelligence
CFA	call forward area; covering force area
CFL	coordinated fire line
CFZ	critical friendly zone
CG	commanding general
cGy	centigray
CH	chaplain
chem	chemical
CHEMO	chemical officer
C-HUMINT	counter-human intelligence
CI	combat intelligence; counterintelligence
CICA	counterintelligence coordinating authority
C-IMINT	counter-image intelligence
CINC	commander in chief (the President)
CJCS	Chairman, Joint Chiefs of Staff
CJTF	commander, joint task force
CLF	commander, landing force
CLR STA	clearing station (graphics)
CM	countermobility
cmd	command
CMISE	corps military intelligence support element

CMO	civil-military operations
CMOC	civil-military operations center
CMT	company maintenance team
CNA	computer network attack
CND	computer network defense
CNR	combat net radio
co	company
CO	commanding officer
COA	course of action
COCOM	combatant command (command authority)
COE	contemporary operational environment
COFM	correlation of forces and means
COS	chief of staff
COG	center of gravity
COLT	combat observation and lasing team
COMINT	communications intelligence
comm	communications
COMMZ	communications zone
COMPUSEC	computer security
COMSEC	communications security
CONOPS	concept of operations
CONPLAN	concept plan
const	construction
CONUS	continental United States
COP	common operational picture
COSC	combat and operational stress control
COSCOM	corps support command
CP	checkpoint; command post; contact point
CPSE	corps PSYOP support element
CPU	chemical protective undergarment
CPX	command post exercise
CQB	close quarters battle
CRC	component repair company
CRT	combat repair team
CS	civil support; combat support
CSA	Chief of Staff, United States Army; corps sustainment area
CSAR	combat search and rescue
CSG	corps support group

CSH	combat support hospital
C-SIGINT	counter-signal intelligence
CSR	controlled supply rate
CSS	combat service support
CSSE	combat service support element
CT	counterterrorism
CTCP	combat trains command post
CTIL	commander's track item list
CW	chemical warfare
CWT	customer wait time
CZ	combat zone
—D—	
D	dental (graphics)
D3A	decide, detect, deliver, and assess
DA	Department of the Army; direct action
DAO	division ammunition officer
DASB	division area support battalion
DC	dislocated civilian
DCA	Defense Communications Agency; defensive counterair
DCM	deputy chief of mission
DCS	Defense Communications System; defensive counterspace
DCSINT	Deputy Chief of Staff for Intelligence
DCSOPS	Deputy Chief of Staff for Operations
DD	double double (Bailey Bridge)
DE	directed energy
DEFCON	defense readiness condition
demo	demolitions
det	detachment
det cord	detonation cord
DEW	directed-energy warfare
DF	direction finding
DFSCOORD	deputy fire support coordinator
DGZ	desired ground zero
DIA	Defense Intelligence Agency
DID	defense in depth
DIMHRS	Defense Integrated Military Human Resource System
DISCOM	division support command
DISE	division intelligence support element

DISN	Defense Information Systems Network
DISUM	daily intelligence summary
div	division
DIVARTY	division artillery
DIVENG	division engineer
DLIC	detachment left in contact
DMG	degrees magnetic north
DMZ	demilitarized zone
DNBI casualty	disease and nonbattle injury casualty
DOA	dead on arrival; direction of attack
DOCEX	document exploitation
DOD	Department of Defense
DODIPP	Department of Defense Intelligence Production Program
DOS	day of supply; Department of State
DOTMLPF	doctrine, organization, training, materiel, leader education, personnel, and facilities
DOW	died of wounds
DP	decision point
DPPDB	digital point positioning database
DR	direction range
DRB	division ready brigade
DS	direct support; double single (Bailey Bridge)
DSA	division support area
DSM	decision support matrix
DSO	deception staff officer
DSS	decisive, shaping, and sustaining
DST	decision support template
DSU	direct support unit
DT	double triple (Bailey Bridge)
DTED	digital terrain elevation data
DTG	date-time group
DTN	degrees true north
DTSS	digital topographic support system
DWG	deception working group
DWRIA	died of wounds received in action
DX	direct exchange
DZ	drop zone

—E—

E&E	evasion and escape
E&R	evasion and recovery
EA	electronic attack; emergency action; engagement area; environmental assessment
EAB	echelons above brigade
EAC	echelons above corps
EAD	echelons above division
EATL	electronic attack target list
EBA	engineer battlefield assessment
ECM	electronic countermeasures
ECR	environmental conditions report
EECT	end evening civil twilight
EEFI	essential elements of friendly information
EENT	end evening nautical twilight
EF	end of radioactive fallout
eff	effective
EID	electronic identification
ELINT	electronic intelligence
ELSEC	electronics security
EMCON	emission control
EMI	electromagnetic interference
EMP	electromagnetic pulse
EN	engineer (unit designations; graphics)
ENCOM	engineer command
ENCOORD	engineer coordinator
eng	engineer
ENY	enemy (graphics)
EOB	electronic order of battle
EOD	explosive ordnance disposal
EP	electronic protection
EPAS	environmental performance assessment system
EPB	electronic preparation of the battlefield
EPW	enemy prisoner of war
equip	equipment
ERP	engineer regulating point
ES	electronic warfare support
ESB	enhanced separate brigade

ESM	electronic surveillance measures; electronic warfare support measures
EVAC	evacuation
EW	early warning; electronic warfare
EWL	engineer work line
EZ	extraction zone
—F—	
FA	field artillery
FAA	forward assembly area
FAAD	forward area air defense
FAADEZ	forward area air defense engagement zone
FAAWC	force antiair warfare commander
FAC	forward air controller
FAC-A	forward air controller-airborne
FARP	forward arming and refueling point
FASCAM	family of scatterable mines
fax	facsimile
FB	fire base
FBCB2	Force XXI battle command—brigade and below
FCC	flight coordination center
FCL	final coordination line
FDC	fire direction center
FDO	flexible deterrent option; fire direction officer
FDRP	first destination reporting point
FEBA	forward edge of the battle area
FES	forced entry switch
FEST	forward engineer support team
FEZ	fighter engagement zone
FFA	free-fire area
FFE	field force engineering; fire for effect
FFIR	friendly force information requirements
FH	field hospital
FHA	foreign humanitarian assistance
FID	foreign internal defense
FISINT	foreign instrumentation signals intelligence
FIST	fire support team
FLB	forward logistics base
fld	field

FLE	forward logistics element
FLO	fighter liaison officer
FLOT	forward line of own troops
FM	field manual; frequency modulated/modulation
FMC	full mission-capable
FMF	Fleet Marine Force
FO	forward observer
FOB	forward operating base; forward operations/operational base
FOC	flight operations center
FP	force protection
FPCON	force protection condition
FPF	final protective fire
FPL	final protective line
FPOL	forward passage of lines
F-POLE	distance between shooter and target at impact
FRAGO, FRAG order	fragmentary order
FS	fire support
FSA	fire support area; forward support area (NGFS)
FSB	forward support battalion
FSC	fire support coordinator
FSCC	fire support coordination center (USMC)
FSCL	fire support coordination line
FSCM	fire support coordinating measure
FSCOORD	fire support coordinator
FSE	fire support element
FSO	fire support officer
FSS	fire support station (NGFS)
FSSG	force service support group (USMC)
FST	field sanitation team; field support team; forward surgical team
FTCP	field trains command post
fwd	forward
—G—	
G	guard
G-1	Assistant Chief of Staff, Personnel
G-2	Assistant Chief of Staff, Intelligence
G-3	Assistant Chief of Staff, Operations and Plans

G-4	Assistant Chief of Staff, Logistics
G-5	Assistant Chief of Staff, Civil Affairs
G-6	Assistant Chief of Staff, Command, Control, Communications, and Computer Operations (C4 Ops)
GA	tabun (nerve agent)
GB	sarin (nerve agent)
GCC	Gulf Cooperation Council
GCCS	global command and control system
GCE	ground combat element
GCI	ground control intercept
GD	soman (nerve agent)
GEN	general
GEOREF	geographic reference
GI	geospatial information
GIF	graphics interchange format
GIS	geographic information system
GI&S	geospatial information and services
GLINT	gated laser intensifier
GMT	Greenwich Mean Time
GNC	global navigation chart
gp	group
GPS	global positioning system
GR/CS	guardrail/common sensor
GS	general support
GSA	general support artillery
GSM	ground station module
GSR	ground surveillance radar
GS-R	general support-reinforcing
GTL	gun-target line
GW	guerrilla warfare
GZ	ground zero

—H—

H	mustard gas
H&S	headquarters and service
HA	holding area
HACC	humanitarian assistance coordination center
HAHO	high-altitude high-opening (parachute technique)
HALO	high-altitude low-opening (parachute technique)

HARM	high-speed antiradiation missile
HAZCOM	hazard communication
HCA	humanitarian and civic assistance
HD	distilled mustard (blister agent); heavy drop
HE	high explosive
hel	helicopter
HEMMS	hand-emplaced minefield marking set
HEP	high explosive plastic
HET	heavy equipment transporter
HE WAM	high explosive wide area mine
HF	high frequency
HHB	headquarters and headquarters battery (FA and ADA)
HHC	headquarters and headquarters company
HHT	headquarters and headquarters troop (cavalry units)
HIDACZ	high-density airspace control zone
HIGH-G	high gravity
HIMAD	high-to-medium altitude missile air defense
HIMEZ	high-altitude missile engagement zone
HL	mustard-lewisite mixture (blister agent)
HLD	homeland defense
HLS	homeland security
HLZ	hot landing zone
HMMWV	high-mobility multipurpose wheeled vehicle
HN	host nation; nitrogen mustard (blister agent)
HNS	host nation support
HOB	height (depth) of burst
hos	hostile
HPRF	high pulse repetition frequency
HPT	high-payoff target
HPTL	high-payoff target list
HQ	headquarters
HQDA	Headquarters, Department of the Army
HRS	human resources support
HSS	health service support
HT	mustard T-mixture (blister agent)
HTS	high-speed antiradiation missile (HARM) targeting system
HUMINT	human intelligence
HVAA	high-value airborne assets

HVT	high-value target
HVTL	high-value target list
— —	
I&W	indications and warnings
IA	information assurance
IAT	infrastructure assessment team
IAW	in accordance with
ICAC2	integrated combat airspace command and control
ICAO	International Civil Aviation Organization
ID	identification; infantry division
IDAD	internal defense and development
IDM	improved data modem
IDP	initial delay position
IED	imitative electromagnetic deception; improvised explosive device
IEW	intelligence and electronic warfare
IFF	identification, friend or foe
IFV	infantry fighting vehicle
IG	inspector general
IHL	intelligence handover line
IID	improvised incendiary device
IM	information management
IMINT	imagery intelligence
IN	infantry
INFOCON	information operations condition
INFOSEC	information security
INFOSYS	information systems
INS	inertial navigation system
INSCOM	United States Army Intelligence and Security Command
INTSUM	intelligence summary
IO	information operations
IOVAP	information operations vulnerability assessment program
IOVAT	information operations vulnerability assessment team
IP	initial point
IPB	intelligence preparation of the battlefield; intelligence preparation of the battlespace
IPW	interrogation, prisoner of war
IR	information requirements; infrared, thermal

IS	information superiority
ISB	intermediate staging base
ISE	intelligence support element
ISR	intelligence, surveillance, and reconnaissance
ITV	in-transit visibility
IV	intravenous

—J—

JAAT	joint air attack team
JAG	Judge Advocate General
JAOC	joint air operations center
JCMOTF	joint civil-military operations task force
JCS	Joint Chiefs of Staff
JCSE	joint communications support element
JDISS	joint deployable intelligence support system
JEPES	Joint Engineer Planning and Execution System
JEZ	joint engagement zone
JFACC	joint force air component commander
JFC	joint force commander
JFLCC	joint force land component commander
JFMCC	joint force maritime component commander
JFSOCC	joint force special operations component commander
JIB	joint information bureau
JIC	joint intelligence center
JLOTS	joint logistics over-the-shore
JMC	joint movement center
JMISE	joint military intelligence support element
JOA	joint operations area
JOC	joint operations center
JOPEs	Joint Operation Planning and Execution System
JP	joint publication
JPAV	joint personnel asset visibility
JPOTF	joint psychological operations task force
JRA	joint rear area
JRC	joint reception center
JRFL	joint restricted frequency list
J-SEAD	joint suppression of enemy air defenses
JSOA	joint special operations area
JSOACC	joint special operations air component commander

JSOLE	joint special operations liaison element
JSOTF	joint special operations task force
JSOW	joint stand-off weapon
JSTARS	Joint Surveillance Target Attack Radar System
JTAC	joint terminal attack controller
JTB	joint target board
JTF	joint task force
JTF-CND	joint task force—computer network defense
JWICS	Joint Worldwide Intelligence Communications System

—K—

KIA	killed in action
------------	------------------

—L—

L	light (graphics)
LAB	logistics assault base
LADW	local air defense warning
LAN	local area network
LAPES	low-altitude parachute extraction system
LAV	light armored vehicle
LC	line of contact
LCC	land component commander
LD	line of departure
LD/LC	line of departure is line of contact
LEN	large extension node
LF	landing force
LIWA	land information warfare activity
LL	latent lethality; light line
LLTR	low-level transit route
LNO	liaison officer
LO	law and order; liaison officer; lubrication order
LOA	limit of advance
LOB	line of bearing
LOC	line of communications
LOGCAP	logistics civilian augmentation program
LOGPAC	logistics package
LOMEZ	low-altitude missile engagement zone
LOS	line of sight
LOTS	logistics over-the-shore

LOW	law of war
LP/OP	listening post/observation post
LRP	logistics release point
LRS	long-range surveillance
LRSD	long-range surveillance detachment
LRSU	long-range surveillance unit
LSD	least separation distance
LTD	laser target designator
LU	linkup
LZ	landing zone
—M—	
m	mechanized (graphics)
M&S	modeling and simulation
MACCS	Marine air command and control system
MACG	Marine air control group
MACOM	major Army command
MACS	Marine air control squadron
MAG	Marine aircraft group
MAGTF	Marine air-ground task force
MAIN	primary command post (graphics)
maint	maintenance
MALS	Marine aviation logistics squadron
MANSPT	maneuver support
MarDiv	Marine division
MASINT	measurement and signature intelligence
MASS	Marine air support squadron
max	maximum
MBA	main battle area
MC	mobility corridor
MCAP	mine clearing/armor protection kit
MCB	mine clearing blade
MCC	movement control center
MCL	mission configured load
MCM	mine countermeasures
M/C-M/S	mobility/countermobility/survivability
MCOO	modified combined obstacle overlay
MCP	maintenance collection point
MCR	mine clearing roller

MCRP	Marine Corps reference publication
MCS	maneuver control system
MDIC	multidisciplinary counterintelligence
MDMP	military decisionmaking process
MDV	mine detection vehicle
MEB	Marine expeditionary brigade
mech	mechanized
med	medical
MED	manipulative electromagnetic deception
MEDEVAC	medical evacuation
MEDINT	medical intelligence
MEF	Marine expeditionary force
MEF(FWD)	Marine expeditionary force (forward)
MEP	military environmental protection; mobile electric power
met	meteorological
METL	mission essential task list
METT-TC	mission, enemy, terrain and weather, troops and support available, time available, civil considerations
MEU	Marine expeditionary unit
MEU(SOC)	Marine expeditionary unit (special operations capable)
MEZ	missile engagement zone
MFDF	medium frequency direction finding
MFF	military free fall
MG	machine gun; major general
MGB	medium girder bridge
MGI	military geographic information
MGRS	military grid reference system
MHE	materials handling equipment
MI	military intelligence
MIA	missing in action
MICLIC	mine clearing line charge
MIJI	meaconing, interference, jamming, and intrusion
MILSTD	military standard
min	minimum
MIST	military information support team
MIW	mine warfare
MLC	military load classification
MLRS	multiple launch rocket system

mm	millimeter
MMC	materiel management center
MMS	maneuver and mobility support
mob	mobilization
MOB	main operations base
MOBA	military operations in a built-up area
MOE	method of evaluation
MOG	maximum on ground
MOOTW	military operations other than war
MOPMS	modular pack mine system
MOPP	mission-oriented protective posture
MORT	mortar
MP	military police
MPA	maritime patrol aircraft; mission planning agent; manpower authorization
MPAD	mobile public affairs detachment
MPC	military pay certificate
MPF	maritime prepositioning force
MPRF	medium pulse repetition frequency
MRB	multirole bridge
MRE	meal, ready to eat
MRL	multiple rocket launcher
MRR	minimum-risk route
MSB	main support battalion
MSC	major subordinate command; Military Sealift Command
MSD	minimum safe distance
MSDS	mission-specific data system
MSE	mobile subscriber equipment
MSI	multi-spectral imagery
MSL	mean sea level
MSR	main supply route
MSS	mission support site
MST	maintenance support team
mt	megaton
MTF	medical treatment facility
MTI	moving target indicator
MTT	mobile training team
MWR	morale, welfare, and recreation

—N—

NAI	named area of interest
NATO	North Atlantic Treaty Organization
NAVSOF	naval special operations forces
NBI	non-battle injury
NBC	nuclear, biological, and chemical
NBCWRS	nuclear, biological, and chemical warning and reporting system
NCC	Navy Component Command
NCO	noncommissioned officer
NCS	net control station
NCTR	noncooperative target recognition
NEO	noncombatant evacuation operations
NFA	no-fire area
NFL	no-fire line
NGA	National Geospatial-Intelligence Agency
NGFS	naval gunfire support
NGIC	National Ground Intelligence Center
NGLO	naval gunfire liaison officer
NGO	nongovernmental organization
NIDS	network intrusion detection system
NIPRNET	Non-Secure Internet Protocol Router Network
NIST	national intelligence support team
NLT	not later than
NM	nautical mile
NMCM	not mission capable, maintenance
NMCS	not mission capable, supply
NOK	next of kin
NOTAM	notice to airman
NOV	notice of violation
NPG	network participating group
NRT	near real time
NSFS	naval surface fire support
NSWG	naval special warfare group
NSWU	naval special warfare unit
NURC	nonunit-related cargo
NVD	night vision device

—O—

OA	objective area
OAKOC	observation and fields of fire, avenues of approach, key terrain, obstacles, and cover and concealment
OAS	offensive air support
OB or OOB	order of battle
obj	objective
OCA	offensive counterair
OCS	offensive counterspace
ODCSOPS	Office of the Deputy Chief of Staff for Operations and Plans
ODSS	offense, defense, stability, and support
OEG	operation exposure guide
O/O	on order
OOTW	operations other than war
OP	observation post
OPCOM	operational command (NATO only)
OPCON	operational control
OPFOR	opposing force
OPLAN	operation plan
opns	operations
OPORD	operation order
OPSEC	operations security
OPTASK	operational tasking
ORA	obstacle restricted area
ORF	operational readiness float
ORP	objective rally point
OSINT	open source intelligence
OT	observer-target

—P—

PA	public affairs
PAA	position area for artillery
PAD	public affairs department
PAG	public affairs group
PAOC	public affairs operations center
PATR	populated area targeting record
PAV	personnel asset visibility
PB	panel bridge
PC	personal computer

PCA	psychological consolidation activities
PD	point of departure
PDB	psychological operations dissemination battalion
PDC	psychological operations development center
PDF	principal direction of fire
PE	peace enforcement
pers	personnel
PGIP	predicted ground impact point
PGM	precision guided munitions
PIO	public information officer
PIR	priority intelligence requirements
PIREP	pilot report
PL	phase line
PLD	probable line of deployment
PLS	palletized load system
plt	platoon
PM	preventive maintenance; project manager; provost marshal
PMCS	preventive maintenance checks and services
PME	peacetime military engagement
PO	peace operations
POD	port of debarkation
POE	port of embarkation
POG	psychological operations group
POL	petroleum, oils, and lubricants
POS/NAV	position/navigation
POTF	psychological operations task force
POW	prisoner of war
PP	passage point
PPI	plan position indicator
PRC	populace and resource control
PRF	pulse repetition frequency
PROWORD	procedure word
PSE	PSYOP support element
psn	position
PSPA	peace support psychological activities
PSYACT	psychological action
PSYOP	psychological operations
PSYWAR	psychological warfare

PTAD	planning terrain-analysis database
pub	publication
PUP	pop-up point
PVNTMED	preventive medicine
PW	prisoner of war
PWRS	prepositioned war reserve stock
PZ	pickup zone
PZCO	pickup zone control officer
—Q—	
QSTAG	Quadrapartite Standardization Agreement (ABCA)
—R—	
R	reinforcing
R3P	rearm, refuel, and resupply point
RAA	rear assembly area
RAAM	remote antiarmor mine
RAAMS	remote antiarmor mine system
RAD	radiation absorbed dose
radiac	radioactivity, detection, indication, and computation
RAS	rear area security
RAU	radio access unit
RB	radar beacon; ribbon bridge
RC	reserve component
RCA	riot control agent
RCERT	regional computer emergency response team
RCU	remote control unit
RD	radius of damage; rifle division
REAR	rear command post (graphics)
REBS	rapidly emplaced bridge system
recon	reconnaissance
regt	regiment
REMS	remotely employed sensor
RES	radiation exposure status
retrans	retransmission
RF	radio frequency; response force
RFA	restrictive fire area
RFI	request for information
RFID	radio frequency identification

RFL	restrictive fire line
RGR	ranger (graphics)
RI	relevant information
RIP	relief in place
RL	release line
RM	risk management
ROA	restricted operations area
ROE	rules of engagement
ROM	refuel-on-the-move
ROTA	releases other than attack (related nuclear, biological, and chemical)
ROZ	restricted operations zone
RP	rally point; reference point; release point
RPB	regional PSYOP battalion
RPOL	rearward passage of lines
RPV	remotely piloted vehicle
RRR	rapid runway repair
RS	radiation status; religious support
RSO&I	reception, staging, onward movement, and integration
RSR	required supply rate
RSTA	reconnaissance, surveillance, and target acquisition
RTE	route
RV	radius of vulnerability
RWR	radar warning receiver
—S—	
S	scatterable mines (graphics); screen
S&P	stake and platform
S&TI	scientific and technical intelligence
S-1	personnel staff officer
S-2	intelligence staff officer
S-3	operations staff officer
S-4	logistics staff officer
S-6	command, control, communications and computer operations (C4 Ops) officer
S/A	surface to air
SA	security assistance; staging area
SAAFR	standard use Army aircraft flight route
SAB	separate armored brigade

SAR	search and rescue
SAEDA	subversion and espionage directed against the Army
SALUTE	size, activity, location, unit, time, and equipment
SAM	surface-to-air missile
SASP	special ammunition supply point
SAT	security assistance team
SATCOM	satellite communications
SCAME	source, content, audience, media, effects
SCATMINE	scatterable mine
SCG	security classification guide
SCI	sensitive compartmented information
SEAD	suppression of enemy air defenses
SEAL	sea-air-land team
SECDEF	Secretary of Defense
SED	simulative electronic deception
SEE	small emplacement excavator
SEN	small extension node
SEP	separate
SERE	survival, evasion, resistance, and escape
SF	special forces
SFC	sergeant first class; special forces command
SFOB	special forces operations/operational base
SFOD-ABC	special forces operational detachment—Alpha/Bravo/Charlie
SHAPE	Supreme Headquarters Allied Powers Europe
SHELREP	shelling report
SHF	super-high frequency
SHORAD	short-range air defense
SHORADEZ	short-range air defense engagement zone
SIB	separate infantry brigade
SIF	selective identification feature
sig	signal
SIGINT	signals intelligence
SIGSEC	signals security
SIPRNET	SECRET Internet Protocol Router Network
SITMAP	situation map
SITREP	situation report
SJA	staff judge advocate
SO	special operations

SOA	special operations aviation
SOCCE	special operations command and control element
SOCOORD	special operations coordination element
SOF	special operations forces
SOFA	status-of-forces agreement
SOI	signal operating/operation instructions
SOLL	special operations low-level
SOP	standing operating procedure
SOSB	special operations support battalion
SOSCOM	special operations support command
SOSR	suppress, obscure, secure, and reduce
SOSRA	suppress, obscure, secure, reduce, and assault (breaching fundamentals)
SOT-A/B	special operations team—Alpha/Bravo
SP	self-propelled; start point; strongpoint
SPECAT	special category
SPOD	sea port of debarkation
SPOE	sea port of embarkation
SPOTREP	spot report
SPS	special psychological operations study
spt	support
sqd	squad
sqdn	squadron
SR	special reconnaissance
SRD	secret restrictive data
ST	SEAL team
STANAG	standardization agreement (NATO)
STO	special technical operations
STRIKWARN	strike warning
SUPCOM	support command
SURFREP	surf report
surveil	surveillance
svc	service
—T—	
TA	target analysis; target acquisition
TAACOM	Theater Army Area Command
TAB	target acquisition battery
tac	tactical

TAC	tactical (artillery, naval gunfire, and close air support) (graphics)
TACAIR	tactical air
TACAN	tactical air navigation
TACC	tactical air command center (USMC); tactical air control center (USN)
TACCP	tactical command post
TACLAN	tactical local area network
TACOM	tactical command (NATO only)
TACON	tactical control
TACP	tactical air control party
TACSAT	tactical satellite
TADIL	tactical digital information link
TAF	tactical air force
TAI	targeted area of interest
TALCE	tanker airlift control element
TALO	tactical air liaison officer; theater airlift liaison officer
TAV	total asset visibility
TBM	tactical ballistic missile; theater ballistic missile
TBMD	tactical ballistic missile defense; theater ballistic missile defense
TBMPGIP	tactical ballistic missile projected ground impact point
TCF	tactical combat force
TCP	traffic control post
TDA	table of distribution and allowances
TEB	tactical exploitation brigade
TECHCON	technical control
TECHINT	technical intelligence
TEL	transporter erector launcher
TERF	terrain flight
TF	task force
tgt	target
TIB	toxic industrial biological
TIC	toxic industrial chemical
TIH	toxic industrial hazard
TIM	toxic industrial material
TIR	toxic industrial radiological
TIRS	terrain index reference system

Operational Acronyms, Abbreviations, and Country Codes

TLAM	Tomahawk land-attack missile
TLP	troop leading procedures
tm	team
TM	theater missile
TMD	theater missile defense
TMFDB	tactical minefield data base
T/MVD	towing/mine-detection vehicle
TOC	tactical operations center
TOD	time of day
TOE	table of organization and equipment
TOR	terms of reference
TOT	time on target (naval gunfire, mortar, and close air support)
TOW	tube-launched, optically tracked, wire-guided
TPC	tactical pilot chart; tactical psychological operations company
TPD	tactical psychological operations detachment
TPFDD	time-phased force and deployment data
TPFDL	time-phased force and deployment list
TPT	tactical psychological operations team
TRADOC	United States Army Training and Doctrine Command
trans	transportation
TRP	target reference point; troop
TS	top secret
TSM	target synchronization matrix
TSS	target selection standard
TTP	tactics, techniques, and procedures
—U—	
UAV	unmanned aerial vehicle
UCL	unit configured load
UGS	unattended ground sensors
UHF	ultrahigh frequency
UMCP	unit maintenance collection point
UMT	unit ministry team
UNAAF	Unified Action Armed Forces
USACAC	United States Army Combined Arms Center
USAF	United States Air Force
USAFSOC	United States Air Force special operations command
USAID	United States Agency for International Development
USASOC	United States Army Special Operations Command

USCENTCOM	United States Central Command
USCG	United States Coast Guard
USEUCOM	United States European Command
USFK	United States Forces Korea
USMC	United States Marine Corps
USN	United States Navy
USPACOM	United States Pacific Command
USSOUTHCOM	United States Southern Command
USSPACECOM	United States Space Command
UT1	Universal Time
UTC	Coordinated Universal Time
UTM	universal transverse mercator
UTO	Universal Time Observed
UW	unconventional warfare
UXO	unexploded explosive ordnance
—V—	
V	veterinary (graphics)
VA	vulnerability assessment
VFR	visual flight rules
VHF	very high frequency
VITD	vector interim terrain data
—W—	
WARNO	warning order
WCS	weapons control status
WEZ	weapon engagement zone
WFZ	weapons free zone
WGS	world geodetic system
WIA	wounded in action
WMD	weapons of mass destruction
WME	warfighting mass effect
—Z—	
Z	Zulu Time
ZOS	zone of separation
ZULU	Universal Time

SECTION II – TWO-LETTER GEOGRAPHICAL ENTITY CODES

2-1. The following list of two-letter geographical entity codes was taken from NATO STANAG 1059, *Distinguishing Letters for Geographical Entities for Use in NATO*.

—A—

AA	Aruba
AC	Antigua and Barbuda
AF	Afghanistan
AG	Algeria
AJ	Azerbaijan
AL	Albania
AM	Armenia
AN	Andorra
AO	Angola
AR	Argentina
AS	Australia
AT	Ashmore and Cartier Islands
AU	Austria
AV	Anguilla
AY	Antarctica

—B—

BA	Bahrain
BB	Barbados
BD	Bermuda
BE	Belgium
BF	Bahamas
BG	Bangladesh
BH	Belize
BJ	Bjoernoeya (Bear Island)
BK	Bosnia and Herzegovina
BL	Bolivia
BN	Benin
BO	Belarus
BR	Brazil
BS	Bassas da India
BT	Bhutan

BU Bulgaria
BV Bouvet Island
BX Brunei
BY Burundi

—C—

CA Canada
CB Cambodia
CD Chad
CF Congo
CG Congo, Democratic Republic of (Zaire)
CH China
CI Chile
CJ Cayman Islands
CK Cocos (Keelig) Islands
CM Cameroon
CN Comoros
CO Colombia
CR Coral Sea Islands
CS Costa Rica
CT Central African Republic
CU Cuba
CV Cape Verde
CW Cook Islands
CY Cyprus
CZ Czech Republic

—D—

DA Denmark
DJ Djibouti
DO Domenica
DR Dominican Republic

—E—

EC Ecuador
EG Egypt
EI Ireland
EK Equatorial Guinea
EN Estonia
ER Eritrea

Operational Acronyms, Abbreviations, and Country Codes

ES El Salvador
ET Ethiopia
EU Europa Islands

—F—

FG French Guiana
FI Finland
FJ Fiji
FK Falkland Islands
FM Federated States of Micronesia
FO Faeroe Islands
FP French Polynesia (including Tahiti)
FQ Kingman Reef
FR France
FS French southern and Antarctic lands (excluding Terre Adelie)
FY Republic of Macedonia (Former Yugoslav Republic of Macedonia)

—G—

GA Gambia
GB Gabon
GE Germany
GG Georgia
GH Ghana
GI Gibraltar
GJ Grenada
GL Greenland
GO Glorioso Islands
GP Guadeloupe
GQ Guam
GR Greece
GT Guatemala
GU Guernsey
GV Guinea
GY Guyana

—H—

HA Haiti
HK Hong Kong
HM Heard and McDonald Islands
HO Honduras

HQ	Howland Island
HR	Croatia
HU	Hungary
—I—	
IC	Iceland
ID	Indonesia
IM	Isle of Man
IN	India
IO	British Indian Ocean Territory
IP	Clipperton
IR	Iran
IS	Israel
IT	Italy
IV	Ivory Coast
IZ	Iraq
—J—	
JA	Japan
JE	Jersey
JM	Jamaica
JN	Jan Mayen
JO	Jordan
JQ	Johnston Atoll
JU	Juan de Nova Island
—K—	
KE	Kenya
KG	Kyrgyzstan
KN	North Korea
KQ	Baker Island
KR	Kiribati
KS	South Korea
KT	Christmas Island
KU	Kuwait
KZ	Kazakhstan
—L—	
LA	Laos
LE	Lebanon
LG	Latvia

LH	Lithuania
LI	Liberia
LO	Slovakia
LQ	Palmyra Atoll
LS	Liechtenstein
LT	Lesotho
LU	Luxembourg
LY	Libya

—M—

MA	Madagascar (Malagasy Republic)
MB	Martinique
MC	Macao
MD	Moldova
ME	Mayotte
MG	Mongolia
MH	Montserrat
MI	Malawi
ML	Mali
MN	Monaco
MO	Morocco
MP	Mauritius
MQ	Midway Islands
MR	Mauritania
MT	Malta
MU	Oman
MV	Maldives
MY	Malaysia
MX	Mexico
MZ	Mozambique

—N—

NA	Netherlands Antilles
NC	New Caledonia
NE	Niue
NF	Norfolk Island
NG	Niger
NH	Vanuatu
NI	Nigeria

NL Netherlands
 NO Norway
 NP Nepal
 NR Nauru
 NS Surinam
 NU Nicaragua
 NZ New Zealand

—P—

PA Panama
 PC Pitcairn Islands
 PE Peru
 PF Parcel Islands
 PG Spratly Islands
 PK Pakistan
 PL Poland
 PM Panama
 PO Portugal
 PP Papua New Guinea
 PS Paulau
 PU Guinea Bissau

—Q—

QA Qatar

—R—

RE Reunion
 RM Marshall Islands
 RO Romania
 RP Philippines
 RQ Puerto Rico
 RS Russia
 RW Rwanda

—S—

SA Saudi Arabia
 SB St. Pierre and Miquelon
 SC St. Kitts and Newvis
 SE Seychelles
 SF South Africa
 SG Senegal

SH	St. Helena
SI	Slovenia
SL	Sierra Leone
SM	San Marino
SN	Singapore
SO	Somalia
SP	Spain
SS	Samoa
ST	St. Lucia
SX	South Georgia and South Sandwich Islands
SU	Sudan
SV	Svalbard
SW	Sweden
SY	Syria
SZ	Switzerland

—T—

TC	United Arab Emirates
TD	Trinidad and Tobago
TE	Tromelin Island
TH	Thailand
TI	Tajikistan
TK	Turks and Caicos Islands
TL	Tokelau Islands
TM	East Timor
TN	Tonga
TO	Togo
TP	Sao Tome and Principe
TS	Tunisia
TU	Turkey
TV	Tuvalu
TX	Turkmenistan
TW	Taiwan
TZ	Tanzania

—U—

UG	Uganda
UK	United Kingdom
UP	Ukraine

US	United States	
UV	Burkina	
UY	Uruguay	
UZ	Uzbekistan	
		—V—
VC	St. Vincent	
VE	Venezuela	
VI	Virgin Islands	
VM	Vietnam	
VT	Vatican City	
		—W—
WA	Namibia	
WF	Wallis and Futuna	
WQ	Wake Island	
WS	Western Samoa	
WZ	Swaziland	
		—X—
XA	Bophuthatswana	
		—Y—
YE	Yemen	
YU	Yugoslavia Federal Republic (Serbia and Montenegro)	
		—Z—
ZA	Zambia	
ZI	Zimbabwe	

Chapter 3

Multi-Service Brevity Codes, Procedure Words, and Tactical Tasks

SECTION I – BREVITY CODES

3-1. A brevity code is a code which provides no security but which has as its sole purpose the shortening of messages rather than the concealment of their content. Approved brevity codes may be used when preparing military records, publications, correspondence, messages, operation plans, orders, and reports. The following brevity codes have been taken from FM 3-54.10/MCRP 3-25B, *Brevity: Multiservice Brevity Codes*. Symbols and abbreviations accompanying the brevity words and definitions are explained as follows:

- * Meaning may vary from the NATO code word.
- ** Not a NATO brevity word
- “[NATO]” NATO brevity word not used by US forces, but may be encountered in multinational operations.
- (A/A) Definition applies to air-to-air operations.
- (A/S) Definition applies to air-to-surface operations
- (S/A) Definition applies to surface-to-air operations.
- (S/S) Definition applies to surface-to-surface operations.
- (EW) Definition applies to electronic warfare operations.
- (AIR-MAR) Definition applies to maritime air operations. All brevity codes pertain to general air operations unless otherwise indicated.

All brevity codes pertain to general air operations unless otherwise indicated.

ABORT	Directive call to cease action/attack/event/mission.
ACTION	Directive call to initiate a briefed attack sequence or maneuver.
(system) ACTIVE (location/direction)	(EW) Referenced emitter is radiating at the stated location or along the stated bearing.
**ADD (system/category)	Directive call to add a specific (system) or (EOB category) to search responsibilities.
ALARM	Directive/informative call indicating the termination of EMCON procedures. Opposite of SNOOZE.
ALLIGATOR	Link-11/TADIL A.

ALPHA CHECK	Request for/confirmation of bearing and range from aircraft to described point.
ANCHOR(ED)	<ol style="list-style-type: none"> 1. Directive call to orbit about a specific point (location). 2. Informative call to indicate a turning engagement at a specific location. 3. Refueling track flown by tanker.
ANGELS	Height of friendly aircraft in thousands of feet from mean sea level (MSL).
*ANYFACE	Friendly GCI/AEW command and control agency when call sign is not known.
ARIZONA	No anti-radiation missile (ARM) ordnance remaining.
ARM	CONTACT(s) resulting from target maneuvers exceeding GROUP criteria.
AS FRAGGED	Unit or element will be performing exactly as stated by their air tasking order (ATO).
**ASLEEP	Enemy air defense system is not operating and is not expected to engage friendly fire. Opposite of AWAKE.
ATTACK(ING)	(A/S) Directive/informative call indicating aircraft are committed to air-to-surface delivery on a specific ground target. Direction/bearing from which the weapon will be coming may be given.
**ATTACK COMPLETE	(A/S) Mandatory call from the attack aircraft to the Joint Terminal Attack Controller (JTAC) during Type III control indicating completion of ordnance release. (See also CLEARED TO ENGAGE.)
AUTHENTICATE	To request or provide a response to a coded challenge.
AUTOCAT	Any communications relay using automatic retransmissions.
**AWAKE	Enemy air defense system is operating and may engage friendly aircraft. Opposite of ASLEEP.
(weapon) AWAY	Release/launch of specified weapon (e.g., BIRDS AWAY, PIGS AWAY, LONG RIFLE AWAY, etc.). (NOTE: Include launch location in bullseye format and weapons track direction for PIGS and LONG RIFLE.)
*AZIMUTH	<ol style="list-style-type: none"> 1. (A/A) A picture label describing two GROUPS separated laterally. *GROUP names will be referenced by cardinal directions (e.g., NORTH GROUP, SOUTH GROUP, or EAST GROUP, WEST GROUP). (NOTE: NATO definition includes two or more GROUPS.) 2.* (S/A) Direction to the threat.
BANDIT	An aircraft identified as an enemy in accordance with theater ID criteria. The term does not necessarily imply direction or authority to engage.
BANZAI	Informative/directive call to execute launch and decide tactics.

BASE (+/- number)	Reference number used to indicate such information as headings, altitude, fuels, etc.
BAY	[NATO] (EW) Carry out deception plan indicated or in accordance with previous orders.
BEAD WINDOW	Last transmission potentially disclosed unauthorized information.
*BEAM (w/cardinal direction)	Contact stabilized within 70 to 110 degrees of aspect. (NOTE: NATO = 60 to 120 degrees of aspect.)
BEANSTALK	[NATO] Information call advising datalink users to check equipment for spurious tracks.
**BEARING (w/sub- cardinal direction)	Inner GROUP formation with the trailer displaced approximately 45 degrees behind the leader.
(system) BENT	System indicated is inoperative. Cancelled by OKAY.
BINGO	Fuel state needed for recovery.
BIRD	Friendly surface-to-air missile (SAM).
BIRD(S) AFFIRM	Surface-to-air informative call indicating a FRIENDLY unit is able and prepared to engage a specified target with SAMs. Opposite of BIRD(S) NEGAT.
BIRD(S) NEGAT	Surface-to-air informative call indicating a FRIENDLY unit is unable to engage a specified target with SAMs. Opposite of BIRD(S) AFFIRM.
BITTERSWEET	Notification of possible blue-on-blue (fratricide) on blue-on-neutral situation relative to a designated track or FRIENDLY aircraft.
BLIND	No visual contact with FRIENDLY aircraft/ground position. Opposite of VISUAL.
BLOTTER	[NATO] (EW) ECM receiver.
BLOW THROUGH	Directive/informative call that aircraft will continue straight ahead at the merge and not become ANCHORED with target(s).
BOGEY	A radar or visual air CONTACT whose identity is unknown.
BOGEY DOPE	Request for target information as requested or for closest GROUP in BRAA (with appropriate fill-ins).
BOX	A picture label with GROUPS in a square or offset square. (See CHAMPAGNE and VIC for GROUP names.)
BRAA	<ol style="list-style-type: none">1. Following information is in a tactical control format providing target bearing, range, altitude, and aspect relative to the specified friendly aircraft.2.* Request/directive call to switch to tactical BRAA control format.
BRACKET	Directive call to maneuver to a position on opposing sides, either (direction) laterally or vertically from the target.

BREAK (direction)	Directive call to perform an immediate maximum performance 180-degree turn (or as directed) in the indicated direction.
BREAK AWAY	Tanker or receiver call indicating immediate vertical and nose/tail separation between tanker and receiver is required.
**BREVITY	Directive call indicating the radio frequency is becoming saturated, degraded, or jammed and briefer transmissions must follow. (NOTE: see NATO term ZIPLIP.)
BROADCAST	Request/directive call to switch to broadcast control format.
BROKE LOCK	Advisory call regarding loss of radar/IR lock-on.
BRUISER	Friendly air-launched antiship missile.
**BUDDY (LASE/GUIDE)	(A/S) Request or informative communications to have guidance of a weapon from a source other than delivering aircraft.
BUDDY LOCK	Locked to a known friendly aircraft. Normally a response to a "SPIKED" or "BUDDY SPIKE" call.
BUDDY SPIKE	Friendly aircraft radar lock-on indication on radar warning receiver (position/heading/alt) (RWR).
BUGOUT	(direction) Separation from that particular engagement/attack/operation with no intent to reengage/return.
BULLDOG	(S/S) Friendly surface-/submarine-launched antiship missile.
BULLRING	(AIR-MAR) Maritime aircraft patrol.
BULLSEYE	An established reference point from which the position of an object can be referenced by bearing (magnetic) and range (NM) from this point.
BUMP/BUMP-UP	(A/S) A climb to acquire line of sight (LOS) to the target or laser designation.
**BURN	Informative call that Gated Laser Illuminator (GLINT) is being used to provide illumination. Typically employed by AC-130 to illuminate surface points of interest.
BUSTER	Directive call to fly at maximum continuous speed (military power).
BUTTON	Radio channel setting.
**BUZZER	Electronics communications jamming. (NOTE: same as NATO term CHATTER.)
**CANDYGRAM	(EW) Informative call to aircraft that electronic warfare targeting information is available on a briefed secure net.
CAP/CAPPING	<ol style="list-style-type: none"> 1. Directive call to establish a combat air patrol (CAP) at a specified location. 2. Descriptive term for aircraft in a CAP.
CAPTURED	(A/S) Aircrew has acquired and is able to track a specified surface target with an on-board sensor.

CAV-OK	Cloud and Visibility Okay (pronounced kav-okay). ICAO term meaning no significant clouds below 5,000 feet, visibility at least six miles, no precipitation or storms.
CEASE (activity)	Directive to discontinue stated activity, e.g., CEASE BUZZER, CEASE LASER, etc.
CEASE	(S/A) A fire control order used to direct air defense units to stop tactical ENGAGEMENT action against a specified target. Guided missiles already in flight will continue to intercept.
CEASE FIRE	(S/A) Discontinue firing/do not open fire. Missiles in flight are allowed to continue to intercept; continue to track.
CEASE LASER	Aircraft-to-aircraft directive to stop firing laser. Opposite of LASER ON.
CHAMPAGNE	A picture label describing three distinct GROUPs with two in front and one behind. *GROUP names should be NORTH LEAD GROUP and SOUTH LEAD GROUP or WEST LEAD GROUP and EAST LEAD GROUP and TRAIL GROUP.
**CHANNEL	Stacked net within a Link 16 Network.
CHARLIE	1.* (AIR-MAR) The expected landing time on the ship. 2. (AIR-MAR) Directive to land aircraft on ship. 3.* (time in minutes) (AIR-MAR) An advisory call modifying/delaying the briefed recovery time (e.g., CHARLIE TEN).
CHATTERMARK	Directive call to begin using briefed radio procedures to counter communications jamming.
**CHEAPSHOT	AIM-120 missile datalink terminated between high and medium PRF active.
CHECK (number, LEFT/RIGHT)	Turn (number) degrees left or right and maintain new heading.
**CHECK FIRING	(S/S) Directive call to cease firing immediately.
** CHECKPRINT (track #)	1. Request an air defense commander for unit(s) to provide amplifying information on a specified track. 2. Reply/informative to air defense commander followed by positive track information using format specified in applicable OPTASK document.
**CHERUBS	Height of a friendly aircraft in hundreds of feet AGL. (NOTE: NATO definition, when adopted, will not specify AGL or MSL.)
CHICKS	Friendly aircraft.
CLAM	[NATO] (EW) Cease all or indicated electromagnetic and/or acoustic emissions in accordance with national instructions and exercise orders. Potential intelligence collector(s) in area (estimated duration of CLAM hours).

CLEAN	<ol style="list-style-type: none"> 1. No sensor information on nonfriendly group of interest. 2. No visible battle damage. 3. Aircraft not carrying external stores.
CLEARED	Response to requested action is authorized. No engaged/support roles are assumed.
CLEARED HOT	Ordnance release is authorized.
**CLEARED TO ENGAGE	(A/S) JTAC Type III control clearance. Attack aircraft flight leaders may initiate attacks within the parameters imposed by the JTAC. Attack platform will provide ATTACK COMPLETE call to JTAC, indicating completion of ordnance release.
CLOAK	Directive/Informative call to switch from normal/overt external lighting to covert night vision device (NVD) only compatible lighting.
**CLOSING	Decreasing in separation.
CLOWN	[NATO] (EW) Deception jammer.
COLD	<ol style="list-style-type: none"> 1. A descriptive/directive call to initiate a turn in the CAP away from the anticipated threats. 2. Defined area is not expected to receive fire (enemy or friendly). 3. Intercept geometry will result in a pass or roll out behind the target.
**COLOR (system/position)	(EW) Request for information on a type (system) at stated location; implies a request for ambiguity resolution. May be used with IDM datalink data message—COLOR, DATA.
COMEBACK	Directive call to reverse course (direction).
COME OFF (direction)	<ol style="list-style-type: none"> 1. (A/A) Directive call to maneuver as indicated to either regain mutual support or to deconflict flight paths. Implies both VISUAL and TALLY. 2.* (A/S) Directive call to maneuver or execute a specific instruction (e.g., COME OFF DRY).
COMMIT	Directive call to intercept a GROUP of interest.
**COMPOSITION	Request for a number of contacts within a GROUP.
CONFETTI	Chaff lane or corridor.
CONS/CONNING	Descriptive term for nonfriendly aircraft leaving contrails.
CONTACT	<ol style="list-style-type: none"> 1. Sensor contact at the stated position. 2. Acknowledges sighting of a specified reference point. 3.* Individual radar return within a GROUP or ARM.
**CONTAINER	Inner GROUP formation with four CONTACTS oriented in a square or offset square.
CONTINUE	Continue present maneuver; does not imply a change in clearance to engage or expend ordnance.

CONTINUE DRY	Continue present maneuver; ordnance release not authorized. Training use only.
*COVER	Directive/informative call to assign S/A weapons or establish an A/A posture that will allow engagement of a specified track or threat, if required.
CRANK	F-Pole maneuver in the direction indicated; *implies illuminating target (direction) at/near radar GIMBAL limits.
**CROSSING	Descriptive term for when two GROUPs initially separated in azimuth decrease azimuth separation to pass each other.
CRUISE	[NATO] Informative or directive call to return to cruise speed (after BUSTER or GATE).
CUTOFF	Request for, or directive to, intercept using cutoff geometry.
CYCLOPS	Any UAV.
DANCE (column codeword/ designator)	[NATO] (EW) Shift all lines to COMPLAN (insert codeword).
DASH (#)	Aircraft position within a flight. Use if specific call sign is unknown.
**DATA (object, position)	Standby for datalink message concerning object at stated location.
DEADEYE	Informative call by an airborne laser designator indicating the laser system is inoperative.
DECLARE	Inquiry as to the identification of a specified track(s), target(s), or correlated GROUP.
**DEEP	Descriptive term used to indicate separation between the nearest and farthest GROUPs in range in a relative formation of three or more groups, used to describe a LADDER, VIC, CHAMPAGNE, BOX.
DEFENDING (direction)	Aircraft is in a defensive position and maneuvering with reference to a surface-to-air threat.
*DEFENSIVE	Aircraft is under attack, maneuvering defensively, and unable to ensure deconfliction or mutual support.
**DELOUSE	Directive call to detect, identify, and engage (if required) unknown aircraft trailing friendly aircraft.
DELTA (insert altitude) (insert position)	(AIR-MAR) Hold and conserve fuel at altitude and position indicated during shipboard operations.
DEPLOY	Directive call for the element to maneuver to briefed position.
**DETAILS	Request for modified J-FIRE 9-line brief from Joint Surveillance Target Attack Radar System (Joint STARS).
**DIAMONDS (w/position)	An IR event location.
DIRTY	Link is not encrypted.

DIVERT	Proceed to alternate base/*mission.
DOLLY	Link-4A/TADIL C.
** (system) DOWN (location/direction)	(EW) Referenced emitter has stopped radiating at the stated location or along the stated bearing. (NOTE: DOWN does not mean system destroyed.)
DRAG	(cardinal direction) Contact aspect stabilized at 0-60-degree angle from tail or 120-180-degree angle from nose.
DROPP(ING)	<ol style="list-style-type: none"> 1. Directive/informative call to stop monitoring a specified emitter/target and resume search responsibilities. 2. Informative call that fighter has discontinued tracking responsibility. 3. (TRACK___) Remove the emitter/target from tactical picture/track stores. 4.* (EW) Directive call to remove a specific system or EOB category from search responsibilities.
DUCK	[NATO] Informative/directive call to descend and increase speed.
DUFFER	(EW) DF-equipped unit.
*ECHELON (sub- cardinal direction)	Fill-in to a picture label describing GROUPs aligned behind and to the side of the closest group.
ECHO	Positive System M/Mode X (or comparable system) reply.
**EMPTY	(EW) No emitters of interest detected. (NOTE: equivalent to NATO term BLANK.)
ENGAGE	A fire control order used to direct or authorize units and/or weapon systems to fire on a designated target.
*ENGAGED	Informative interflight call from a fighter maneuvering in the visual arena. (NOTE: NATO definition is, "Descriptive call indicating maneuvering with intent to kill.")
ESTIMATE	Estimate of the size, range, height, or other parameter of a specified contact; implies degradation.
EXTEND(ING) (direction)	Short-term maneuver to gain energy, distance, or separation, normally with the intent of reengaging
EYEBALL	<ol style="list-style-type: none"> 1. Fighter with primary visual identification responsibility. 2. EO/IR acquisition of an aircraft. Normally followed by number of aircraft observed.
FADED	Radar contact is lost on nonfriendly air/surface contact and any positional information given is estimated.
*FAST	Target speed is estimated to be 600-900 knots/Mach 1-1.5. (NOTE: NATO = 400 knots to 600 knots/Mach 1.)
FATHER	(AIR-MAR) Shipboard TACAN station.
FEELER	[NATO] (EW) Shipborne fire control radar.
FEET WET/DRY	Flying over water/land.

FENCE (IN/OUT)	Set cockpit switches as appropriate before entering/exiting the combat area.
FERRET	[NATO] (EW) Airborne electronic reconnaissance activity or aircraft.
FLANK (direction)	CONTACT aspect stabilized at 120- to 150-degree angle from tail or 30- to 60-degree angle from nose of aspect.
FLARE(S)	Directive to deploy flares.
FLASH (system)	Temporarily activate specified system for identification purposes (IFF/afterburner/flare/chaff/etc.).
**FLASHLIGHT	Directive term for helicopter to turn on IR floodlight (pointed at ground to aid visual acquisition by escort aircraft).
FLAVOR	Visually identified nationality of a contact.
FLOAT	Directive/informative call to expand the formation laterally within visual limits to maintain radar contact or prepare for a defensive response.
**FLOW (direction)	Directive call to fly stated heading.
FOX (number)	Simulated/actual launch of A/A weapons. ONE—Semiactive radar-guided missile. TWO—infrared-guided missile. THREE—active radar-guided missile.
**FOX THREE (X) SHIP	Valid missile shot against (x) separate targets (assumes 1 missile per target).
**2nd FOX THREE	Simulated or actual launch of multiple active radar-guided missiles on the same target.
FOX MIKE	VHF/FM radio.
FREEZE BURN	Directive call to AC-130 to freeze the GLINT position in the present location.
FRIENDLY	A positively identified friendly aircraft, *ship, or *ground position.
**FUEL STATE (time)	(AIR-MAR) A helicopter's fuel quantity, expressed in hours and minutes, before having to make a controlled emergency landing.
*FURBALL	Descriptive/informative call indicating known nonfriendly aircraft and friendly aircraft are in close proximity to each other. Can be response to a DECLARE request. (NOTE: NATO equivalent term is MIX-UP. NATO definition of FURBALL is, "A turning fight involving multiple aircraft.")
GADABOUT (#)	[NATO] Informative call indicating the upper limit of height sanctuary for fighters in the MEZ. ("GADABOUT 25" means the upper limit of the height sanctuary is 25,000 feet; "GADABOUT 16 to 24" means the height sanctuary is between 16,000 and 24,000 feet.)
GADGET	Radar or emitter equipment.
GATE	Directive/informative call to fly as quickly as possible, using afterburner/max power.

**GENIE	(EW) Emitter is employing electronic protection measures.
GIMBAL	Radar target is approaching azimuth or elevation tracking limits.
GINGERBREAD	Voice imitative deception is suspected on this net.
GLOWWORM	[NATO] Flare-dropping aircraft.
GO ACTIVE	Go to briefed frequency agile net.
GO CLEAR	Use unencrypted voice communications.
**GOGGLE/ DEGOGGLE	Directive call to put on/take off NVDs.
**GOGGLES ON/OFF	Informative call that NVDs are on/off.
GOODWILL	Informative call indicating the boundary of an active friendly MEZ.
**GOPHER	A BOGEY that has not conformed to safe passage routing, airspeed, or altitude procedures. Will only be used when safe passage or minimum risk routing procedures are part of an ID matrix.
GORILLA	Large force of indeterminate numbers and formation.
GO SECURE	Activate encrypted voice communications.
GRANDSLAM	All HOSTILE aircraft of a designate track (or against which a mission was tasked) are shot down.
GREEN (direction)	Direction determined to be clearest of enemy air-to-air activity.
**GREYHOUND	Friendly ground attack cruise missile (e.g., TLAM).
GRIDIRON	[NATO] (EW) Jamming signal appears on my PPI scope or jamming signal prevents determination of range and bearing (insert #) % of time.
*GROUP	Any number of air contacts within 3 NM in azimuth or range of each other. (NOTE: NATO definition includes an altitude discrimination of within 20,000 feet.)
GUNS	Reference to A/A or A/S gun engagement.
**HANDSHAKE	Link 16 Air Control NPG initiation between air control unit and controlled aircraft.
HARD (direction)	High-G, energy sustaining 180-degree turn (or as directed) in the indicated direction.
**HEADBUTT	Directive term to fighters/interceptors to immediately divert a track of interest clear of a restricted or prohibited area.
HEADS UP	Alert of an activity of interest.
*HEAVY	A GROUP known to contain three or more individual entities. (NOTE: NATO definition is, "The largest GROUP of factor BOGEYS/BANDITS.")

Multi-Service Brevity Codes, Procedure Words, and Tactical Tasks

*HIGH	CONTACT is greater than 40,000 ft MSL. (NOTE: NATO is 25,000 to 50,000 ft MSL.)
HIT(S)	<ol style="list-style-type: none">1. Momentary radar return(s).2. (altitude) (A/A) Indicates approximate target altitude (e.g., GROUP BULLSEYE 360/10, HITS 15 THOUSAND).3. (A/S) Weapons impact within lethal distance.
HOLD DOWN	Directive to key transmitter for DF steer.
HOLD FIRE	(S/A) An emergency fire control order to stop firing on a designated target, to include destruction of any missiles in flight.
HOLDING HANDS	Aircraft in visual formation.
**HOLLOW	Any datalink message not received.
HOME PLATE	Home airfield or ship.
HOOK	<ol style="list-style-type: none">1. (direction) Directive call to perform an in-place 180-degree turn.2. (descriptor)** Datalink directive call to cue sensors to described A/S point (point of interest, SAM, markpoint, TN, etc.).
*HOSTILE	<p>A contact identified as enemy upon which clearance to fire is authorized in accordance with theater rules of engagement.</p> <p>NOTE: the above use of hostile is used as a brevity term for air-to-air and air-to-surface engagements and should not be confused with the same term in TADIL and ROE.</p> <p>NOTE: NATO "HOSTILE" brevity term does not necessarily constitute authorization to fire. Theater commander should specify in ATO SPINS the exact definition of HOSTILE brevity terms for multinational operations.</p>
HOT	<ol style="list-style-type: none">1. A descriptive/directive call to initiate a turn in the CAP toward anticipated threats.2.* Defined area is expected to receive fire (enemy or friendly).3. (A/S) Ordnance employment intended or completed.4. CONTACT aspect stabilized at 160- to 180-degree angle from tail or 0- to 20-degree angle from nose.
**HOTDOG (color)	Informative/directive call that a friendly aircraft is approaching or is at a specified standoff distance from the sovereign airspace of a nation (as defined by national boundaries or territorial sea and airspace). (COLOR may indicate additional standoff distance.) Follow briefed procedures.
HOTEL FOX	HF radio.

HOUND DOG	[NATO] (A/A) Call made by free fighter indicating that he is in a position to employ weapons.
HUFFDUFF	[NATO] (EW) HFDF equipment or unit fitted with HFDF equipment.
HUSKY	Informative call that the AIM-120 is at HPRF active range.
ID	<ol style="list-style-type: none"> 1. Directive call to identify the target. 2. Informative call that identification is accomplished, followed by type.
**IDLE	Joint STARS call indicating vehicles are stationary.
IN (direction)	<ol style="list-style-type: none"> 1. Informative call indicating a turn toward a known threat. Opposite of OUT. 2. (A/S) Entering terminal phase of an air-to-ground attack. Opposite of OFF.
**IN PLACE (direction)	Perform indicated maneuver simultaneously.
INDIA	Mode IV.
INTERROGATE	Interrogate the designated contact of the IFF mode indicated.
INTRUDER	An individual, unit, or weapon system in or near an operational or exercise area, which represents the threat of intelligence gathering or disruptive activity.
JACKAL	Surveillance network participating group (NPG) of Link 16/TADIL J.
JINK	Directive call to perform an unpredictable maneuver to negate a tracking solution.
JOKER	Fuel state above BINGO at which separation/bugout/event termination should begin.
JUDY	(A/A) Aircrew has radar or visual contact on the correct target, has taken control of the intercept, and only requires situation awareness information. Controller will minimize radio transmissions.
KILL	<ol style="list-style-type: none"> 1.* Directive call to fire on designated target. (NOTE: NATO term is ENGAGE.) 2. (A/A) In training, an informative call by a fighter to indicate kill criteria have been fulfilled.
KNOCK IT OFF	In training, a directive call to cease all air combat maneuvers/attacks/activities/exercises.
KOBOLD	[NATO] Informative call indicating that a specific friendly MEZ is not active. Opposite of OILFIELD.
LADDER	Picture label with three or more groups on the same azimuth but separated by range. *Group names should be LEAD GROUP, MIDDLE GROUP, TRAIL GROUP.
LAME DUCK	An aircraft in a minor state of emergency.

LASER ON	Directive/informative call to start/acknowledge laser designation.
**LASING	Informative call indicating that the speaker is firing the laser.
**LAST	Command and control (C2) term that provides the last contact altitude from a high fidelity source (fighter radar, etc.).
*LEAD-TRAIL	Inner GROUP formation of two contacts separated in range.
LEAKER(S)	Airborne threat has passed through a defensive layer. Call should include amplifying information.
**LEAN (direction)	Directive/informative call to maneuver in a direction to avoid the threat. (NOTE: equivalent NATO term is KICK.)
LEVEL	(A/A) Interflight informative call that contact is co-altitude.
**LIGHTBULB	Directive call for flight to turn all position lights to bright.
LIGHTS ON/OFF	Directive to turn on/off all exterior lights.
LINE ABREAST	Inner GROUP formation of two or more contacts separated in azimuth.
LINER	[NATO] Fly at speed giving maximum cruising range.
LOCKED	<ol style="list-style-type: none">1. (w/group label) Radar lock-on; SORT is not assumed.2. (w/position) Radar lock-on; correct targeting is not assumed.
**LONG RIFLE	(A/S) Friendly, long-range A/S missile launch (e.g., AGM-130, SLAM-ER). See (weapon) AWAY.
LOOKING	Aircrew does not have the ground object, reference point, or target in sight (opposite of CONTACT).
*LOW	Contact altitude below 10,000 ft MSL. (NOTE: NATO = 500 to 5,000 feet AGL.)
**LOWDOWN	A request to provide tactical ground information pertinent to the mission in a digital bullseye format.
MADDOG	Visual AIM-120/AIM-54 launch.
MAGNUM (system/location)	(A/S) Launch of friendly antiradiation missiles.
**MANEUVER (AZIMUTH/RANGE/ ALTITUDE)	Informative call that specified GROUP is maneuvering in azimuth, range, and/or altitude.
MAPPING	(A/S) Multifunction radar in an A/G mode.

**MARK	<ol style="list-style-type: none"> 1. Used when aircraft passes over pickup zone/landing zone (PL/LZ) team. 2. Directive term to record the location of a ground point of interest. 3. (S/S) Spotting round (normally white phosphorus [WP]) or illumination on the deck to indicate targets to aircraft, ground troops, or fire support.
**MARKING	Informative call indicating friendly aircraft is leaving contrails. (NOTE: NATO term is CONNING.)
**MARKPOINT MARSHAL(ING)	Datalink nondesignated geographic point of interest. Establish(ed) at a specific point.
*MEDIUM	Contact altitude between 10,000 ft MSL and 40,000 ft MSL. (NOTE: NATO: 5,000 feet AGL to 25,000 feet MSL.)
MERGE(D)	<ol style="list-style-type: none"> 1. Information that friendlies and targets have arrived in the same visual arena. 2. Informative call indicating radar returns have come together.
MICKEY	HAVE QUICK time-of-day (TOD) signal.
MIDNIGHT	Informative call advising C2 radar functions are unavailable due to degradation. Advisory information is still available. Opposite of SUNRISE.
MIKEDUFF	[NATO] (EW) MFDF equipment or unit fitted with MFDF equipment.
**MILLER TIME	(A/S) Informative call indicating completion of air-to-ground ordnance delivery. Generally used by the last striker in conjunction with a precoordinated egress plan.
MONITOR(ING)	<ol style="list-style-type: none"> 1. Maintain(ing) sensor awareness on specified GROUP. 2. (AIR-MAR) Directive call to an aircraft to maintain contact/targeting information on a maritime surface contact.
MOTHER	(AIR-MAR) Parent ship.
**MOVE BURN (bearing)	(A/S) Directive call to AC-130 to move GLINT in specified direction. (NOTE: do not use LEFT/RIGHT for moving a BURN.)
**MOVER(S)	Unidentified surface vehicle(s) in motion.
MUD (type/direction/ range if able)	Informative call indicating RWR ground threat displayed with no launch indication.
MUSIC	Radar electronic deceptive jamming.
NAILS (direction)	<ol style="list-style-type: none"> 1. RWR indication of AI radar in search. (NOTE: NATO term is SPOTTED.) 2.* (A/S) 2.75-inch flechette rockets.
NAKED	No RWR indications.

Multi-Service Brevity Codes, Procedure Words, and Tactical Tasks

**NEAR-FAR	Fighter term depicting a radar-apparent description of two or more contacts within a GROUP separated in range.
**NEGATIVE CONTACT	Sensor information on a friendly aircraft is lost. Termination of CONTACT, track plotting is not warranted.
**NEGATIVE LASER	(A/S) Aircraft has not acquired laser energy.
NEW PICTURE	Used by controller or aircrew when tactical picture has changed. Supersedes all previous calls and re-establishes picture for all players.
NO FACTOR	Not a threat.
NO JOY	Aircrew does not have visual contact with the target/bandit/landmark. Opposite of TALLY.
NOTCH(ING) (direction)	Directive/informative call that an aircraft is in a defensive position and maneuvering with reference to an air-to-air threat.
**OCCUPIED	Ground equipment present at tasked target location. Opposite of VACANT.
OFF (direction)	Informative call indicating attack is terminated and maneuvering to the indicated direction.
OFFSET (direction)	Directive/informative call indicating maneuver in a specified direction with reference to the target.
OILFIELD	[NATO] Activated friendly MEX. Opposite of KOBOLD.
(system) OKAY	System indicated is fully operative (cancels BENT).
ON STATION	Informative call that unit/aircraft has reached assigned station.
OPENING	Increasing in separation.
ORBIT(ING)	Directive (descriptive) call to hold on current or indicated position.
OUT (direction)	Informative call indicating a turn to a cold aspect relative to a known threat.
**OUTLAW	Informative call that a BOGEY has met point of origin criteria for ROE.
PACKAGE	Geographically isolated collection of GROUPs.
PACMAN	[NATO] Informative call that the fighters have found the end of the threat formation and are converting; given in range and bearing from the BULLSEYE (e.g., "BLUE 4 is PACMAN 290/5").
PADLOCKED	Informative call indicating aircrew cannot take eyes off an aircraft, ground target, or surface position without risk of losing TALLY/ VISUAL.
PAINT(S)	An interrogated group/radar contact that is responding with any of the specified IFF/SIF modes and correct codes established for the ID criteria.

PANCAKE	[NATO] Land or I wish to land (reason may be specified, e.g., PANCAKE AMMO, PANCAKE FUEL).
PARROT	IFF/SIF transponder.
**PASSING	Descriptive term for when two GROUPs, initially separated in range, decrease range separation and pass each other.
PEDRO	[NATO] Rescue helicopter.
PICTURE	A request to provide air information pertinent to the mission in a digital bullseye format.
**PIG(S)	Friendly glide weapon(s) (e.g., JSOW). See (weapon) AWAY.
PIGEONS	Magnetic bearing and range to HOMEPLATE.
PINCE	Threat maneuvering for a bracket attack.
PINNACLE	[NATO] (EW) An emission believed to originate from a platform assumed to be FRIENDLY.
PITBULL	<ol style="list-style-type: none"> 1. Informative call that the AIM-120 is at MPRF active range 2. Informative call that the AIM-54 is at active range.
PITCH/ PITCHBACK (LEFT/RIGHT)	Directive call for fighter or flight to execute a nose-high heading reversal.
PLAYMATE	Cooperating aircraft.
PLAYTIME	Amount of time aircraft can remain on station, given in hours plus minutes (e.g., ONE PLUS THIRTY equals one hour and thirty minutes).
(freq) POGO (freq)	Switch to communication channel number preceding POGO. If unable to establish communications, switch to channel number following POGO. If no channel number follows POGO, return to this channel.
**POINT	Datalink sensor point/track of interest.
POLAR BEAR (direction)	[NATO] Friendly aircraft has VISUAL/contact on the FRIENDLY PACKAGE and is joining.
POP	<ol style="list-style-type: none"> 1. (A/S) Starting climb for A/S attack. 2. Max performance climb out of low-altitude structure.
**POPCORN	CSAR aircraft departing the landing zone (LZ). Usually followed by number of recovered personnel (e.g., "STING 1, POPCORN PLUS 2").
POPEYE	Flying in clouds or area of reduced visibility.
POP-UP	<ol style="list-style-type: none"> 1. (A/A) Informative call of a GROUP that has suddenly appeared inside of briefed range. 2.* (S/A) Criteria used as a self-defense method, within the ROE, to protect friendly air defense elements from HOSTILE aircraft.

POSIT	Request for friendly position; response in terms of a geographic landmark or from a common reference point.
POST HOLE	Rapid descending spiral.
PRESS	Directive call that a requested action is approved and mutual support will be maintained.
PRINT (type)	Active NCTR reply.
PUMP	A briefed maneuver to minimize closure on the threat or geographical boundary with the intent to re-engage. Used to initiate a Grinder tactic.
PURE	Informative call indicating pure pursuit is being used or directive to go pure pursuit.
PUSH (channel)	Directive to switch to designated frequency; no acknowledgment required.
PUSHING	Departing designated point.
**QUAIL	Enemy air-/surface-launched cruise missile.
RACKET	(EW) Intercepted electronic emission that has been assigned to a number of the trackblock.
**RANGE	A picture label describing two GROUPs separated in distance along the same line of bearing. GROUP names will be LEAD GROUP/TRAIL GROUP.
RAYGUN (position heading/altitude)	Indicating a radar lock-on to unknown aircraft. A request for a BUDDY SPIKE reply from friendly aircraft meeting these parameters.
**RED LIGHT	Time when search and rescue (SAR) aircraft is no longer SAR capable.
REFERENCE (direction)	Directive to assume stated heading.
RENO	[NATO] (A/A) Indicates that more than one radar contact is observed and the pilot is able to distinguish his assigned target.
RENT	(EW) Report of characteristics of an intercepted signal.
**REPEAT	<ol style="list-style-type: none">1. (S/S) Directive call (during adjustment) to fire again using the same firing data.2. (S/S) Directive call (during fire for effect) to fire the same number of rounds using the same method of fire for effect.
**REPORTED (information)	Information provided is derived from an off-board source.
RESET	Proceed to a pre-briefed position or area of operations.
**RESTAKE	Request for Joint STARS to drive a new STAKE at the target centroid reported with direction of travel and elevation. Initiated by aircrew.
RESUME	Resume last formation/route/mission ordered.

RETROGRADE	Directive/informative call to withdraw in response to a threat, continue mission as able; may RESET/RESUME if threat is negated.
RIDER	A BOGEY that is conforming to safe passage routing, airspeed, or altitude procedures.
RIFLE	(A/S) Friendly air-to-surface launch.
RIPPLE	(A/S) Two or more munitions released or fired in close succession.
ROGER	Indicates the receipt of radio transmission; does not indicate compliance or reaction.
ROLEX (+/- time)	Time line adjustment in minutes always referenced from original preplanned mission execution time. PLUS means later; MINUS means earlier.
ROPE	Circling an IR pointer around an aircraft to help the aircraft identify the friendly ground position.
**ROTATOR	Joint STARS Moving Target Indicator (MTI) return that signifies a high probability of a rotating antenna.
RUMBA	1.* Radar has detected jamming/mutual interference but has not resolved the type. 2. [NATO] Own ship maneuvering for ranging.
SADDLED	Informative call from wingman or element indicating the return to briefed formation position.
SAM (direction)	Visual acquisition of a SAM in flight or a SAM launch; should include position.
SAME	Informative reply indicating that the aircrew has the identical information as was just stated.
SANDWICHED	Aircraft or element is between opposing aircraft or elements.
SAUNTER	Fly at best endurance.
SCAN	[NATO] Search sector indicated and report any contacts.
**SCHLEM	(A/A) Training term for simulated high off boresight IR missile launch. Not assessable for a simulated kill/kill removal.
SCRAM (direction)	1. Directive/informative call to egress for defensive or survival reasons; no further HVAA mission support is expected. 2. [NATO] Directive call to cease the intercept and take immediate evasive action. Implies that the target aircraft is being engaged by SAMS or other air defense fighters.
SCRAMBLE	Takeoff as quickly as possible.
**SCRUB	Joint STARS Moving Target Indicator (MTI) return that signifies a low, slow airborne target.
SCUD	Any threat theater ballistic missile (TBM).

SEARCHER	(EW) Unit having intercept equipment without DF capability. All references to DUFFERS are applicable to searchers within their capabilities.
SEPARATE(ING)	Leaving a specific engagement; may or may not reenter.
**SEPARATION	Request for separation between two GROUPs. Response will include the follow-on GROUP's separation, altitude, and fill-ins.
SHACKLE	One weave, a single crossing of flight paths; maneuver to adjust or regain formation parameters.
SHADOW	Follow indicated target.
SHIFT (direction)	Directive call to shift laser/IR/radar/device energy.
SHOOTER	Aircraft/unit designated to employ ordnance.
**SHOPPING	An aircraft request to Joint STARS for a target.
**SHOT	(S/S) Informative call indicating round(s) has(ve) been fired.
SHOTGUN	<ol style="list-style-type: none">1. Pre-briefed weapons state.2. [NATO] Pre-briefed weapons state at which separation/bugout should begin.
** (system) SICK	System indicated is degraded/partially operative. (NOTE: NATO term is SOUR.)
**SIDE-SIDE	Fighter term depicting a radar-apparent description of two or more CONTACTs within a GROUP separated in azimuth.
(system) SILENT	<ol style="list-style-type: none">1. (time) System will be unavailable for time indicated.2.* Directive/informative call to indicate datalink is, or should be placed, in receive only.3. [NATO] (EW) Broadcast station is not transmitting. May also be used as an order and must be followed by a frequency or station designator. If possible, it should be followed by an estimated time or return to the air.
SINGER (type/direction)	Informative call of RWR indication of SAM launch.
SINGLE	Descriptive call indicating one GROUP, CONTACT, etc.
SKATE	(A/A) Informative or directive call to execute launch-and-leave tactics.
**SKINNY	Current survivor coordinates.
SKIP IT	Veto of fighter COMMIT, usually followed with further directions.
SKOSH	(A/A) Aircraft is out of/unable to employ active radar missiles.
SKUNK	A maritime surface contact that has not yet been identified.
SLAPSHOT (type/bearing)	Directive call for an aircraft to immediately employ a best available HARM against a specified threat at the specified bearing.

SLICE/SLICEBACK (LEFT/RIGHT)	Directive call to perform a high-G descending turn in the stated direction, usually a 180-degree turn
**SLIDE	Directive/informative call to/from HVAA to continue present mission while flowing from station in response to perceived threat; implies intent to RESET.
SLIP(PING)	(A/S) Directive (or informative) call indicating the attacker will attack the target at the alternate TOT.
*SLOW	Contact with ground speed of less than 200 knots. (NOTE: NATO = 200 to 400 knots.)
SMASH (ON/OFF)	Directive call to turn on/off anticollision lights.
SMOKE	(A/S) Smoke marker used to mark a position.
SNAKE	(A/S) Directive call to oscillate an IR pointer about a target.
SNAP	1.* Fighter request for immediate BRAA call (with appropriate fill-ins) to the group described. Indicates fighter intent to intercept/join. 2. (heading) Urgent directive call to turn to a heading.
**SNAPLOCK (BRAA)	Informative call indicating fighter has obtained a radar contact inside briefed threat range, aspect, or radar mode.
SNIFF (type)	(EW) Passive sensor indication of a radar emitter.
SNIPER (type, location [range, bearing])	Directive call for an aircraft to employ a range-known HARM against a specified threat at the specified location.
SNOOPER	[NATO] An aircraft employed in the detection and reporting of opposing forces while avoiding detection by those forces.
SNOOZE	Directive or informative call indicating initiation of EMCON procedures. Opposite of ALARM.
SORT	Directive call to assign responsibility within a GROUP; criteria can be met visually, electronically (radar), or both.
SORTED	Sort responsibility within a GROUP has been met.
SOUR	(Opposite of SWEET.) 1. (mode/type) Invalid/no response to an administrative IFF/SIF check. 2.* (link name) (e.g., "TIMBER SOUR") Indicates there are potential problems with net entry and initiates permission link troubleshooting. 3. [NATO] Equipment indicated is not operating efficiently.
SPADES	An interrogated group/radar contact which lacks all of the ATO (or equivalent) IFF/SIF modes and codes required for the ID criteria.
SPARKLE	1. (A/S) Target marking by IR pointer. 2. (A/S) Target marking by gunship/FAC-A using incendiary rounds.

SPIKE(D) (direction)	RWR indication of an AI threat in track or launch.
SPIN	Directive or informative call to execute a timing/spacing maneuver.
SPLASH(ED)	<ol style="list-style-type: none">1. (A/A) Target destroyed.2. (A/S) Weapons impact.3.* (S/S) Informative call to observer or spotter five seconds prior to estimated time of impact.
SPLIT	Informative/directive call that flight member is leaving formation to pursue a separate attack; VISUAL may not be maintained.
SPLITTER (direction)	An aircraft that has departed from the engagement or is departing the engaged fighter's targeting responsibility.
SPOOFER	(EW) An entity employing electronic or tactical deception measures.
SPOOFING	Informative call that voice deception is being employed.
SPOT	(A/S) Acquisition of laser designation.
SQUAWK (mode/code)	Operate IFF/SIF as indicated or IFF/SIF is operating as indicated.
SQUAWKING (mode #)	An informative/descriptive call denoting a BOGEY is responding with an IFF/SIF mode or code other than that prescribed by the ATO/identification criteria.
STACK	Two or more CONTACTs within GROUP criteria with an altitude separation in relation to each other.
**STAKE	Joint STARS reference point for A/S targeting operations.
**STARE (w/laser code and reference point)	Directive call to cue the laser spot search/tracker function on the specified laser code in relation to the specified reference point. Reference point may include the following: INS steerpoint, GEOREF, bearing and range, or datalink point.
STATUS	<ol style="list-style-type: none">1. Request for an individual's tactical situation.2. (GROUP) Request for a full positional update in digital bullseye format on the specified group.
STEADY	(A/S) Directive call to stop oscillation of IR pointer.
STERN	Request for, or directive to, intercept using STERN geometry.
STINGER	<ol style="list-style-type: none">1. (A/A) Three-ship inner GROUP formation with two lead CONTACTs line abreast and the SINGLE in trail.2.* (S/A) An IR man portable air defense system (MANPADS).
STOP	<ol style="list-style-type: none">1. (A/S) Stop IR illumination of a target.2.* (BURN) (A/S) Directive call to AC-130 to stop GLINT.3. (abort code) [NATO] (A/S) JTAC directs aircrew to abort the attack. This is a mandatory instruction.

STRANGER	Unidentified traffic that is not a participant with the action in progress.
STRANGLE	Turn off equipment indicated.
STRIPPED	Informative call that aircraft is out of prebriefed formation.
STROBE(S) (bearing)	Radar indication(s) of noise jamming.
SUNRISE	Informative call that C2 radar functions are available. Opposite of MIDNIGHT.
**SUNSHINE	(A/S) Directive or informative call indicating illumination of target is being conducted with artificial illumination.
SWEET	(Opposite of SOUR.) 1.* (mode/type) Valid response to an administrative IFF/SIF check request. 2.* (link name) (e.g., TIMBER SWEET) Confirms receipt of datalink information. 3. [NATO] Equipment indicated is operating efficiently.
SWITCHED	Indicates an attacker is changing from one aircraft to another.
**TAG (system, location)	(EW) Response to an emitter ambiguity resolution request (COLOR).
TALLY	Sighting of a target, nonfriendly aircraft, landmark, or enemy position. Opposite of NO JOY.
TARGET	Directive call assigning targeting responsibilities.
TARGETED	Informative call that GROUP responsibility has been met.
TEN SECONDS	(A/S) Directive to terminal controller to standby for LASER ON call in approximately 10 seconds.
TERMINATE	1. (A/S) Stop laser illumination of a target. 2. In training, cease local engagement without affecting the overall exercise.
THREAT (direction)	Untargeted HOSTILE/BANDIT/BOGEY is within a briefed range of a friendly aircraft.
THROTTLES	Reminder to set throttles, appropriately considering the IR threat and desired energy state.
**THUNDER	(A/S) Informative call one minute prior to A/S weapons impact.
TIED	Positive radar contact with element or aircraft.
TIGER	Enough fuel and ordnance to accept a commitment.
TIMBER	The Link 16 network.
TIMECHECK	Informative call to check/change IFF code.
**TOGGLE	Execute a briefed change of an avionics setting.
**TOY	HARM targeting system (HTS) pod.

TRACK (direction)	GROUP/CONTACT's direction of flight/movement.
** (system)	Enemy air defense system is maintaining situational awareness on friendly.
TRACKING	
**TRACK NUMBER(#)	Datalink information file.
TRASHED	Informative call that missile has been defeated.
TRAVEL	[NATO] (EW) Change radar frequency.
TRESPASS (system, position)	The addressed flight is entering the threat SAM ring of a specific (system) at the stated location.
TROUT	[NATO] (EW) Take a DF bearing on transmission indicated.
TUMBLEWEED	Indicates limited situational awareness (i.e., NO JOY, BLIND) and is a request for information.
UNABLE	Cannot comply as requested or directed.
UNIFORM	UHF/AM radio.
**VACANT	Ground equipment not present at tasked target location. Opposite of OCCUPIED.
VAMPIRE	Hostile antiship missile.
VECTOR	Alter heading to magnetic heading indicated. (Use of true headings to be established before operation commences.)
**VERY FAST	Target speed greater than 900 knots/1.5 Mach.
VIC	Picture label with three groups with the single closest in range and two groups, azimuth split, in trail. *Group names should be LEAD GROUP and NORTH TRAIL GROUP and SOUTH TRAIL GROUP or EAST TRAIL GROUP and WEST TRAIL GROUP.
VICTOR	VHF/AM radio.
VISUAL	Sighting of a friendly aircraft or ground position. Opposite of BLIND.
WALL	Picture label with three or more groups primarily split in azimuth. *Group names should be NORTH GROUP, MIDDLE GROUP, SOUTH GROUP or WEST GROUP, MIDDLE GROUP, EAST GROUP.
WARNING (color)	Hostile attack is: (RED) Imminent or in progress. (YELLOW) Probable. (WHITE) Improbable (all clear).

WEAPONS	(S/A) Fire only: <ol style="list-style-type: none"> 1. (FREE)—at targets not identified as FRIENDLY IAW current ROE. 2. (TIGHT)—at targets positively identified as HOSTILE IAW current ROE. 3. (HOLD/SAFE)—in self-defense or in response to a formal order.
**WEDGE	Three-ship inner GROUP formation with a single CONTACT closest in range and two trail CONTACTs line abreast.
WEEDS	Indicates that aircraft are operating close to the surface.
**WEIGHTED (cardinal direction)	Descriptive term used for a multiple GROUP formation (WALL LADDER, VIC, CHAMPAGNE) that is offset in one direction.
WHAT LUCK	Request for results of missions or tasks.
WHAT STATE	Request for amount of fuel and missiles remaining. Response to WHAT STATE is— <ol style="list-style-type: none"> 1.* (US response) <ul style="list-style-type: none"> (1st number) number of active radar missiles remaining. (2nd number) number of semi-active radar missiles remaining. (3rd number) number of IR missiles remaining. BY (4th number) thousands of pounds of fuel (given to one decimal point) or time remaining. Example response to WHAT STATE: “BLUE TWO IS 3-1-2 BY 7 POINT 5” is equivalent to 3 AIM-120s, 1 AIM-7, 2 AIM-9s and 7,500 lbs of fuel remaining. 2. (item) Ammunition and oxygen are reported only when specifically requested or critical. 3. [NATO response] <p>WEAPONS (insert # - insert #) (-insert PLUS, MINUS, or ZERO and #) I have (insert #) semi-active plus (insert #) IR missiles. Remaining and gun ammunition is (PLUS, MINUS, ZERO). (PLUS)—Gun(s) fitted and sufficient ammunition for a gun attack. (MINUS)—Gun(s) fitted but not sufficient ammunition for a gun attack. (ZERO)—No gun(s) fitted. A fourth character can be given to indicate the number of front hemisphere-capable missiles available (e.g., an aircraft with a serviceable radar, loaded with 2 Sparrows, 2 Phoenixes, 2 Sidewinder AIM-9Ls, and fully loaded gun would report its state as “WEAPONS 4-2-PLUS-6”).</p>
**WIDE	Descriptive term used to indicate the separation between the farthest GROUPs in azimuth in a relative formation of three or more groups, used to describe a WALL, VIC, CHAMPAGNE, or BOX.

WILCO	Will comply with received instructions.
WINCHESTER	No ordnance remaining.
WOOFER	[NATO] (EW) Off board active radar decoy.
WORDS	Directive or interrogative call regarding further information or directives pertinent to the mission.
WORKING	<ol style="list-style-type: none"> 1. (system w/location) Platform gathering EOB on a designated emitter. 2. Platform executing EID on a specific aircraft/group to obtain identification necessary for BVR employment.
**YARDSTICK	Directive to use A/A TACAN for ranging.
ZAP	Request for datalink information.
ZIPLIP	Directive call to minimize radio transmissions.

SECTION II – PROCEDURE WORDS (PROWORDS)

3-2. To keep voice transmissions as short and clear as possible, radio operators employ procedure words (prowords)—a word or phrase limited to radio telephone procedure, used to facilitate communication by conveying information in a condensed standard form. The following is a list of commonly used prowords; their meanings are given in chapter 1.

all after	I authenticate	silence
all before	I read back	silence lifted
authenticate	I say again	speak slower
authentication is	I spell	this is
break	I verify	time
correct	message	to
correction	more to follow	unknown station
disregard this transmission—out	out	verify
do not answer	over	wait
exempt	priority	wait out
figures	read back	wilco
flash	relay to	word after
from	roger	word before
groups	routine	words twice
immediate	say again	wrong
info	service	

SECTION III – TACTICAL MISSION TASKS

3-3. A tactical mission task is the specific activity performed by a unit while executing a form of tactical operation or form of maneuver. It may be expressed in terms of either actions by a friendly force or effects on an enemy force. Tactical mission tasks describe the results or effects the commander wants to achieve, the what and why of a mission statement. The following is

a list of commonly used tactical mission tasks; their meanings are given in chapter 1.

attack by fire	destroy	neutralize
block	disengage	occupy
breach	disrupt	reduce
bypass	exfiltrate	retain
canalize	fix	secure
clear	follow and assume	seize
contain	follow and support	support-by-fire
control	interdict	suppress
counter reconnaissance	isolate	turn
defeat		

This chapter implements STANAG 2019, STANAG 2022, QSTAG 509, and QSTAG 511.

Chapter 4

Military Symbols

A military symbol is a graphic representation of units, equipment, installations, control measures, and other elements relevant to military operations. As a part of doctrine, these symbols provide a common visual language for all users. Standardization of military symbols is essential if operational information is to be passed among military units without misunderstanding. This chapter defines the single standard used to develop and depict hand-drawn and computer-generated military symbols for situation maps, overlays, and annotated aerial photographs for all types of military operations. It provides rules for building specific sets of military symbols. These rules provide details of construction, but allow enough flexibility for the user to build symbols to meet operational needs.

PURPOSE

4-1. The main purpose of military symbology is to allow commanders and staffs to graphically display certain elements of the operational picture. Situation maps, overlays, and annotated aerial photographs are used to express an operation plan or order, concept, or friendly or hostile (enemy) situation. The combination of unit and equipment symbols and control measures, as well as other military symbols, creates an indispensable tool for quickly portraying military operations.

This manual primarily focuses on land military symbols. Chapter 4 discusses a single standard for military symbols. For detailed requirements for the composition and construction of symbols and control measures, see—

- Chapter 5, Unit Symbols.
- Chapter 6, Equipment Symbols.
- Chapter 7, Graphic Control Measures.
- Chapter 8, Installation Symbols.
- Chapter 9, Stability Operations and Support Operations Symbols.

Where applicable, links are provided between symbols and terms for greater understanding. The Army field manuals referenced with the terms provide an explanation of how those terms are used.

The symbology defined in this manual is in compliance with Department of Defense Military Standard 2525, *Common Warfighting Symbology*.

ORIENTATION OF MILITARY SYMBOLS

4-2. All the military symbols in this manual are designed to be displayed with a single orientation. The symbols will be displayed with the top of the symbol pointed north.

COMPOSITION OF MILITARY SYMBOLS

4-3. A military symbol is composed of a frame, color (fill), icon(s), and may include text or graphic modifiers that provide additional information (see figure 4-1.) Included in military symbols are graphic control measures, which are composed of boundaries; lines; areas; points; targets; and nuclear, biological, or chemical attacks/events. The composition of graphic control measures varies from that of unit, equipment, installation, and support operations and stability operations symbols. Graphic control measures have the same attributes as other military symbols, but utilize different rules for building. The details for building graphic control measures are provided in chapter 7 of this manual.

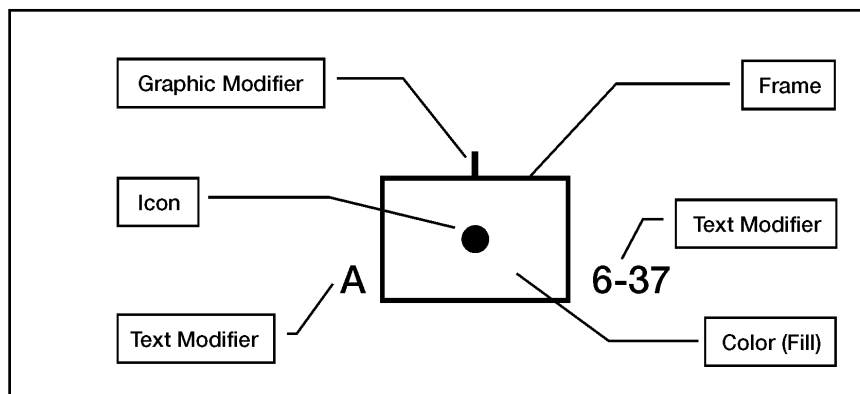

Figure 4-1. Components of a Military Symbol

FRAME

4-4. The frame is the geometric border of a military symbol. It represents affiliation, dimension, and status. The frame serves as the base to which the other components of the symbol are added. A frame can be black or colored, depending on the system being used for representation (see color paragraph below). The frame may include modifiers (U or ?) that are placed inside or outside the frame that help determine affiliation. These modifiers are considered to be an integral part of the frame.

- **Affiliation.** Affiliation refers to the relationship of the symbol being represented to friendly forces. The affiliation categories are friend, assumed friend, hostile, suspect, neutral, unknown, and pending. (The frame shapes for affiliation are shown in table 4-1.)
- **Dimension.** Dimension refers to the primary mission area for the symbol being represented. There are five dimensions that can be represented: land, sea surface, sea subsurface, air and space, and un-









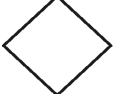

known. Normally, if the dimension cannot or has not been determined, it is considered to be unknown. This manual focuses on the land dimension (see table 4-1).

- **Status.** Status refers to whether a unit is known to be present at the location identified or whether it is a planned or suspected location. Regardless of affiliation, present status is indicated by a solid line and planned or suspected status is indicated by a dashed line (see table 4-2).

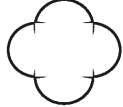
Table 4-1. Frame Shapes for All Affiliations and Dimensions

Dimension →	Land			Sea Surface	Sub Surface	Air & Space	Unknown
	Affiliation ↓	Units	Equipment				
Friend							N/A
Assumed Friend							N/A
Hostile							N/A
Suspect							N/A
Neutral							N/A
Unknown							
Pending							

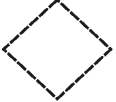
Table 4-2. Status of Symbols

Status	Friendly			Hostile	Neutral	Unknown
	Unit	Equipment	Installation			
Present						
Planned or Suspected						

COLOR (FILL)

4-5. Color indicates affiliation. Color is the hue of the line marking the geometric border or the fill of the interior area of the frame. Table 4-3 depicts the default colors that are used to designate colored symbols for either hand-drawn or computer-generated displays. The use of any colors other than those in table 4-3 for military symbols must be explained in an accompanying legend.

Table 4-3. Color Defaults

<i>Affiliation</i>	<i>Hand-Drawn</i>	<i>Computer-Generated</i>
Friend, Assumed Friend	Blue	Cyan
Hostile, Suspect	Red	Red
Neutral	Green	Green
Unknown, Pending	Yellow	Yellow

ICON

4-6. The icon is the innermost part of the military symbol providing an abstract pictorial or alphanumeric representation of the function or role of the military symbol. Within the frame and as an integral part of a basic icon, there may also be additional graphic or text modifiers that further define the function or role of the military symbol being displayed. See chapters 4, 5, 7, and 8 for application and examples.

TEXT OR GRAPHIC MODIFIERS

4-7. A text or graphic modifier provides additional information about a symbol. This information is displayed on the outside of the frame. The default placement of modifiers in fields around the frame is shown in figure 4-2. The placement of these modifiers is the same, regardless of frame shape.

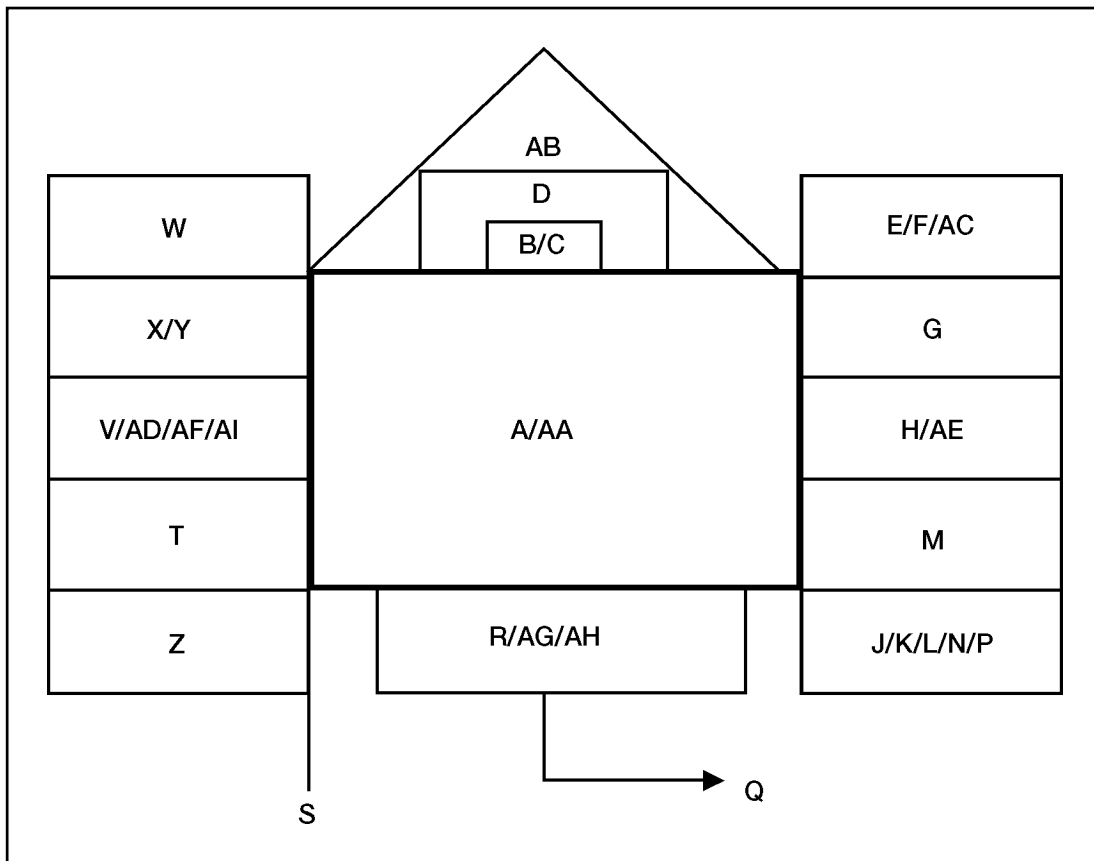

Figure 4-2. Field Positions for Text or Graphic Modifiers

4-8. The field entries in table 4-4 correspond with the field positions in figure 4-2. This table includes all entries used for military symbols. Selected portions of this table are reproduced in chapters 5, 6, 7, 8, and 9 for easy reference in building symbols. For many of the fields in table 4-4, specific entries are found in chapters 5, 6, 7, 8, and 9.

Table 4-4. Descriptions of Fields for Text or Graphic Modifiers for Military Symbols

<i>Field</i>	<i>Field Title</i>	<i>Description</i>	<i>Application</i>	<i>Text/ Graphic</i>
A	Symbol Indicator	Icon or icons that represent the basic functions of the symbol. (The innermost part of a symbol.)	All	Both
B	Echelon	A symbol modifier that denotes the size of a unit (see table 5-6, page 5-33). Also used to denote a command (see paragraph 5-5 and figure 5-3, page 5-34).	Unit, control measures	Both
C	Quantity	A modifier that identifies the number of items present.	Equipment, SO/SO	Text
D	Task Force	A symbol placed over the echelon indicator to denote a task-organized unit (see figure 5-4, page 5-34).	Unit	Graphic
E	Frame Shape Modifier	Helps determine affiliation or battle dimension of symbol. "U" represents unknown battle dimension. Question mark "?" represents suspect or assumed friend affiliation.	Unit, equipment, installation, SO/SO	Text
F	Reinforced or Detached	Indicates whether a unit is reinforced (+), reduced (-), or reinforced and reduced (\pm) (see figure 5-5, page 5-35).	Unit	Text
G	Staff Comments	Free text. Can be used by staff for information required by commander.	Unit, equipment, installation, SO/SO	Text
H	Additional Information	Free text. Additional information not covered by other fields.	All	Text
J	Evaluation Rating	Degree of confidence that may be placed on the information represented by the symbol. It is shown as one letter and one number made up of Reliability of Source and Credibility of Information. Reliability of Source: A. Completely reliable B. Usually reliable C. Fairly reliable D. Not usually reliable E. Unreliable F. Reliability cannot be judged. Credibility of Information: 1. Confirmed by other sources 2. Probably true	Unit, SO/SO, equipment, installation	Text

Table 4-4. Descriptions of Fields for Text or Graphic Modifiers for Military Symbols

<i>Field</i>	<i>Field Title</i>	<i>Description</i>	<i>Application</i>	<i>Text/ Graphic</i>
		3. Possibly true 4. Doubtful 5. Improbable 6. Truth cannot be judged.		
K	Combat Effectiveness	Effectiveness of unit or equipment displayed. 1. Fully operational 2. Substantially operational 3. Marginally operational 4. Not operational	Unit, equipment, installation	Text
	Capacity of Installation	Capacity of installation displayed, such as number of items produced or repaired.		
L	Signature Equipment	Uses an exclamation point “!” as a text modifier to indicate a detectable electronic signature for hostile equipment.	Equipment	Text
M	Higher Formation	Number or title of the next higher echelon command of unit being displayed.	Unit, SO/SO, equipment, installation	Text
N	Hostile (Enemy)	Denotes hostile graphic control measure. The letters “ENY” are used when the color red is not used. Can also be used for neutral or unknown when required. The letters “NEU” or “UNK” are used.	Control measures	Text
P	Identification Friend or Foe (IFF)/Selective Identification Feature (SIF)	IFF/SIF identification modes and codes.	Unit, equipment	Text
Q	Direction of Movement Arrow	With arrow, it denotes the direction symbol is moving or will move.	All	Graphic
		For nuclear, biological, or chemical release events, indicates downwind direction.		
	Offset Location Indicator	Without arrow, it is used to denote precise location of units or to declutter multiple unit locations (see figure 5-6, page 5-42), except for headquarters (see field S).		
R	Mobility Indicator	Pictorial representation of the mobility of the symbol.	Equipment	Graphic

Table 4-4. Descriptions of Fields for Text or Graphic Modifiers for Military Symbols

<i>Field</i>	<i>Field Title</i>	<i>Description</i>	<i>Application</i>	<i>Text/ Graphic</i>
S	Headquarters Staff Indicator	Identifies symbol as a headquarters.	Unit, installation, SO/SO	Graphic
	Offset Location Indicator	Used to indicate precise location of headquarters or to declutter multiple headquarters locations (see figure 5-7, page 5-42).		
T	Unique Designation	An alphanumeric designator that uniquely identifies a particular unit (designation); equipment (number); installation (name).	All	Text
		For friendly nuclear strikes, this designates the friendly delivery system (missile, satellite, aircraft).		
V	Type of Equipment	Identifies unique designation.	Unit, equipment, SO/SO	Text
		Nuclear: Friendly weapons type.		
W	Date-Time Group	An alphanumeric designator for displaying a date-time group (DDHHMMSSZMONYY) or "O/O" for on order. The date-time group is composed of a group of six numeric digits with a time zone suffix and the standardized three-letter abbreviation for the month followed by two digits. The first pair of digits represents the day; the second pair, the hour; the third pair, the minutes. The last two digits of the year are after the month. For automated systems, two digits may be added before the time zone suffix and after the minutes to designate seconds.	All	Text
X	Altitude/Depth	Altitude as displayed on the global positioning system (GPS).	All	Text
		Flight level for aircraft.		
		Depth for submerged objects.		
		Height in feet of equipment or structure on the ground.		
		Nuclear: Height of burst.		
Y	Location	Latitude and longitude or grid coordinates.	All	Text
Z	Speed	Displays speed in nautical miles per hour or kilometers per hour.	Units, equipment,	Text

Table 4-4. Descriptions of Fields for Text or Graphic Modifiers for Military Symbols

<i>Field</i>	<i>Field Title</i>	<i>Description</i>	<i>Application</i>	<i>Text/ Graphic</i>
			SO/SO	
AA	Named C2 Headquarters or SO/SO nonmilitary organizations	This field applies to named commands such as SHAPE, SACLANT, EUCOM, USARPAC, or joint, multinational, or coalition commands such as CJTF, JTF. (see table 5-7, page 5-36). Can be used to indicate international organizations (UN or ICRC/RC), nongovernment organizations (NGO), national governmental agencies (USAID), or regional intragovernmental organizations (EU).	Unit, SO/SO, installation	Text
AB	Feint or Dummy Indicator	Indicates that it is a dummy or a feint for deception purposes.	All	Graphic
AC	Country Indicator	A two-letter code that indicates the country of origin of the unit (see chapter 2). This field can be used also for factions or groups in support operations and stability operations. (Names of factions or groups must be spelled out.)	All	Text
AD	Platform Type	Electronic Intelligence Notation (ELNOT) or Communications Intelligence Notation (CENOT)	Equipment	Text
AE	Equipment Teardown Time	Equipment teardown time in minutes.	Equipment	Text
AF	Common Identifier	Example: Paladin for M109A6 howitzer or Abrams for the M-1 tank.	Unit, equipment	Text
AG	Auxiliary Equipment Indicator	Indicates the presence of a towed sonar array. Used with surface and subsurface equipment.	Equipment	Graphic
AH	Headquarters Elements	Indicates what type of element of a headquarters is being represented, such as TOC, MAIN. (see table 5-8, page 5-39).	Unit	Text
AI	Installation Composition	Indicates the composition of the installation, such as production, service, storage, research, or utility.	Installation	Text

4-9. For information on building air, sea surface, sea subsurface, and space military symbols, refer to Military Standard 2525. The rules for the construction of these military symbols are identical to those for land symbols. All the frame shapes that are used with each of the domains: air, land, sea surface, sea subsurface, and space can be found in table 4-1, page 4-3. This also provides a reference for users of this manual to understand how land symbology fits into joint symbology. Selected parts of the land portions of

table 4-1, page 4-3, are reproduced in chapters 4, 5, 7, and 8 as necessary for the construction of those symbols and the understanding of building symbols.

BASIC RULES FOR BUILDING SYMBOLS

4-10. When building symbols as described in chapters 5 through 7, follow the basic rules:

- Use existing symbols or modifiers whenever possible as building blocks for new symbols.
- Symbols must be usable in both hand-drawn and computer-generated automated modes.
- Symbols must be easily distinguishable so as not to be confused with other symbols.
- Friendly symbols must not use attributes that could be confused with enemy symbols.
- Symbols must be distinguishable without color for use on a monochrome display.
- Composite symbols will generally have the primary symbol centered above or below the modifying symbols.

4-11. All symbols will be drawn or portrayed with the top of the symbol facing the top of the overlay (normally north is at the top). Orientation of the symbol will be accomplished by using the “Q” field for moving symbols or another graphic such as a battle position or support by fire position.

This chapter implements STANAG 2961.

Chapter 5

Unit Symbols

This chapter establishes a single standard for developing land unit symbols. A unit is a military element whose structure is prescribed by a competent authority. This chapter includes a wide variety of unit symbols and modifiers for building new or unique symbols. However, no attempt to depict all unit symbols has been made. Rather, a standard method for constructing unit symbols is presented. Once the user is familiar with the prescribed system, any desired unit can be developed using the logical sequence provided in this chapter. The symbols shown in this chapter are adequate for depicting hostile units. When representing unorthodox units, select the most appropriate symbol contained herein. Avoid using any symbols, or combinations and modifications of symbols, that differ from those in this manual. If, after searching doctrinal symbols and modifiers, it is necessary to create a new symbol, explain the symbol in an accompanying legend. Computer-generated systems may have difficulty in passing nonstandard symbols.

COMPOSITION OF UNIT SYMBOLS

5-1. A unit symbol is composed of a frame, color (fill), branch (an arm of service of the Army/Marine Corps) or functional symbols (icon), and text and/or other symbol modifiers (figure 5-1). (See table 5-1 for the steps used to build unit symbols.)

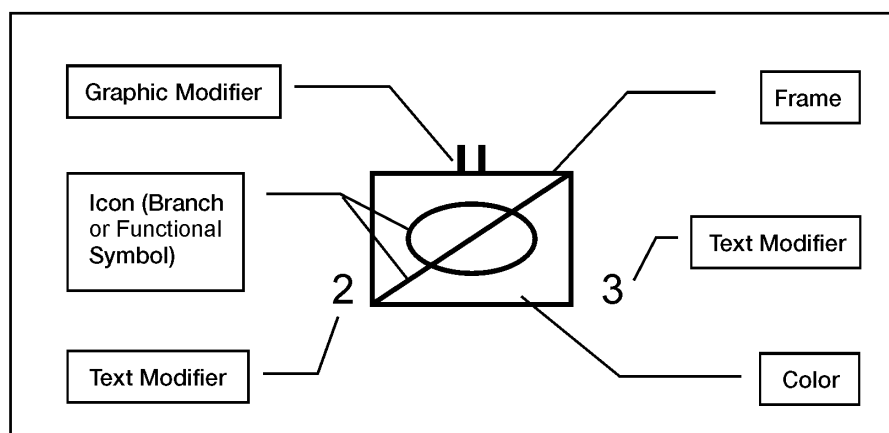

Figure 5-1. Unit Symbol Components

Table 5-1. Building Unit Symbols











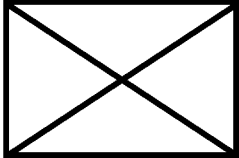

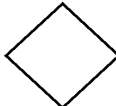
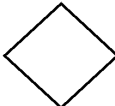

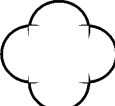

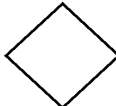
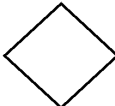

Step #	Step	Example																
Step 1.	First choose the frame that matches the affiliation of the unit (friendly, hostile, neutral). Then choose branch or functional symbol for field "A" (see figure 5-2, page 5-3; table 5-2, page 5-4; and table 5-3, page 5-6). In this example, the affiliation is friendly and the branch is infantry. (See the following land unit frame shapes and affiliations.)	 <p>Friendly Infantry Unit</p>																
	<table border="1"> <thead> <tr> <th data-bbox="201 762 347 846">Affiliation</th> <th data-bbox="347 762 516 846">Friendly</th> <th data-bbox="516 762 662 846">Assumed Friend</th> <th data-bbox="662 762 812 846">Hostile</th> <th data-bbox="812 762 961 846">Suspect</th> <th data-bbox="961 762 1110 846">Neutral</th> <th data-bbox="1110 762 1260 846">Unknown</th> <th data-bbox="1260 762 1421 846">Pending</th> </tr> </thead> <tbody> <tr> <td data-bbox="201 846 347 995">Frame</td> <td data-bbox="347 846 516 995"></td> <td data-bbox="516 846 662 995"></td> <td data-bbox="662 846 812 995"></td> <td data-bbox="812 846 961 995"></td> <td data-bbox="961 846 1110 995"></td> <td data-bbox="1110 846 1260 995"></td> <td data-bbox="1260 846 1421 995"></td> </tr> </tbody> </table>	Affiliation	Friendly	Assumed Friend	Hostile	Suspect	Neutral	Unknown	Pending	Frame								
Affiliation	Friendly	Assumed Friend	Hostile	Suspect	Neutral	Unknown	Pending											
Frame																		
Step 2.	If required, choose the second (additional) branch symbol modifier that further explains the capability of that unit, modifying field "A." In this example, the branch symbol modifier is "mechanized" or "armored" (see table 5-3, page 5-10).	 <p>Friendly Mechanized Infantry Unit</p>																
Step 3.	Again, if required, choose third branch symbol modifier for the next capability, for field "A." In this example, the third function or capability is "wheeled" or more appropriately "wheeled armored vehicle." This is a mobility modifier. It describes the capability of the unit to move personnel and equipment (see table 5-4, page 5-26).	 <p>Friendly Wheeled Armored Infantry Unit</p>																
Step 4.	Choose a fourth branch symbol modifier for any other capability, for field "A." In this example, the fourth function or capability is "gun system equipped." It is possible to have additional symbol modifiers; however, for this example, no further functional or capability modifiers are provided (see table 5-4, page 5-26).	 <p>Friendly Wheeled Armored Infantry Unit with Gun Systems</p>																

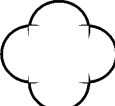
Table 5-1. Building Unit Symbols

Step #	Step	Example
Step 5.	Choose the text or graphic modifiers as necessary to provide further amplifying information. In this example, the graphic modifier is the echelon symbol, or field "B" for a battalion (see table 5-6, page 5-33).	 <p data-bbox="984 667 1425 724">Friendly Wheeled Armored Infantry Battalion with Gun Systems</p>

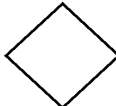
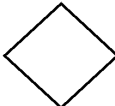
UNIT SYMBOL MODIFIER FIELDS

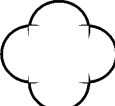
5-2. Figure 5-2 shows the placement of unit labeling fields around the friendly land unit symbol frame. The placement of unit symbol modifier fields is the same regardless of frame shape or affiliation.

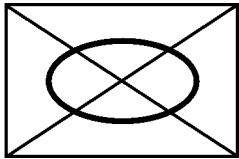
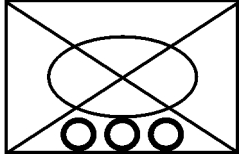
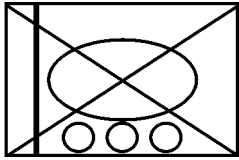
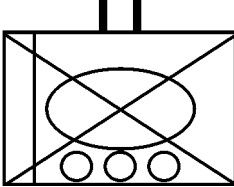
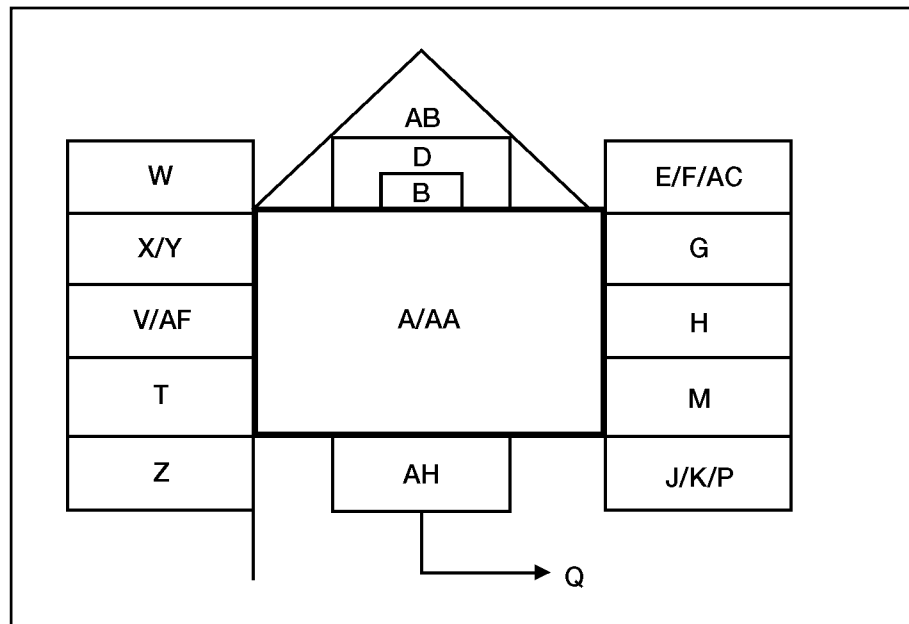

Figure 5-2. Unit Symbol Modifier Fields

5-3. Table 5-2 provides a description of each of the unit symbol modifier fields as shown in figure 5-2. See appendix B for examples of unit symbols with multiple fields that are filled in.

Table 5-2. Descriptions of Fields for Text or Graphic Modifiers for Unit Symbols

<i>Field</i>	<i>Field Title</i>	<i>Description</i>	<i>Text/Graphic</i>
A	Symbol	Basic branch or functional symbol that can include capability modifiers (see table 5-3, page 5-6, and table 5-4, 5-26). (See table 5-5, page 5-30, for special operations forces.)	Both
B	Echelon	A symbol modifier that denotes the size of a unit (see table 5-6, page 5-33).	Both
D	Task Force	A symbol placed over the echelon indicator to denote a task organized unit (see figure 5-4, page 5-34).	Graphic
E	Frame Shape Modifier	Helps determine affiliation or battle dimension of symbol. "U" represents unknown battle dimension. Question mark "?" represents suspect or assumed friend.	Text
F	Reinforced or Detached	Indicates whether a unit is reinforced (+), reduced (-), or reinforced and reduced (\pm).	Text
G	Staff Comments	Free text. Can be used by staff for information required by commander.	Text
H	Additional Information	Free text.	Text
J	Evaluation Rating	Degree of confidence that may be placed on the information represented by the symbol. It is shown as one letter and one number (STANAG 2022) (see chapter 4).	Text
K	Combat Effectiveness	Effectiveness of unit or equipment displayed. 1. Fully operational 2. Substantially operational 3. Marginally operational 4. Not operational	Text
M	Higher Formation	Number or title of higher echelon command of unit being displayed. ¹	Text
P	Identification Friend or Foe (IFF)/Selective Identification Feature (SIF)	Identification modes and codes.	Text
Q	Direction of Movement Arrow/Offset Location Indicator	With arrow, it denotes the direction symbol is moving or will move. Without arrow, it is used to denote precise location or to declutter, except headquarters (see field S and figure 5-6, page 5-42).	Graphic
S	Headquarters Staff Indicator/Offset Location Indicator	Identifies unit symbol as a headquarters or used to indicate precise location or to declutter (see figure 5-5, page 5-35).	Graphic

Table 5-2. Descriptions of Fields for Text or Graphic Modifiers for Unit Symbols

<i>Field</i>	<i>Field Title</i>	<i>Description</i>	<i>Text/Graphic</i>
T	Unique Designation	An alphanumeric designator that uniquely identifies a particular unit (designation). ¹	Text
V	Type of Equipment	Identifies unique designation (such as M-2 for infantry fighting vehicle).	Text
W	Date-Time Group	An alphanumeric designator for displaying a date-time group (DDHHMMSSZMONYY) or "O/O" for on order. The date-time group is composed of a group of six numeric digits with a time zone suffix and the standardized three-letter abbreviation for the month followed by two digits. The first pair of digits represents the day; the second pair, the hour; the third pair, the minutes. The last two digits of the year are after the month. For automated systems, two digits may be added before the time zone suffix and after the minutes to designate seconds.	Text
X	Altitude/Depth	Altitude as displayed on the global positioning system (GPS).	Text
Y	Location	Latitude and longitude; grid coordinates.	Text
Z	Speed	Displays speed in nautical miles per hour or kilometers per hour.	Text
AA	Named C2 Headquarters	This field applies to named commands such as SHAPE, SACLANT, EUCOM, USARPAC or joint, multinational, or coalition commands such as CJTF, JTF, MJTF (see table 5-7, page 5-36).	Text
AB	Feint or Dummy Indicator	Indicates that it is a dummy or a feint for deception purposes.	Graphic
AC	Country Indicator	A two-letter code that indicates the country of origin of the unit (see chapter 2).	Text
AF	Common Identifier	Example: Paladin for M109A6 howitzer or Abrams for the M-1 tank.	Text
AH	Headquarters Element	Indicates what type of element of a headquarters is being represented, such as TOC, MAIN (see table 5-8, page 5-39).	Text
<p>¹ For those units designated under the Combat Arms Regimental System (CARS), both the battalion (or squadron) and traditional regimental numbers are shown. To avoid confusion with different levels of command, both numerical designations of the CARS units are always written together and separated by a dash (-) rather than a slash (/). AR 600-82, <i>The US Army Regimental System</i>, provides a listing of CARS units.</p>			

Table 5-3. Field A: Branch and Functional Symbols

Description	Friend	Hostile	Neutral	Unknown
Combat				
Combat Symbol: Abbreviation for Combat				
Air Defense				
Air Defense (AD) Symbol: Radar Dome				
Air Defense Gun				
Air Defense Missile				
High-to-Medium Altitude Missile Defense (HIMAD)				
Air Defense Composite (Gun and Missile)				
Air Defense Targeting Unit				
Theater Missile Defense (TMD)				
Antiarmor/Antitank				
Antiarmor/Antitank Symbol: Upside Down V				
Armor				
Armor Symbol: Tank Track				
Armored/Track/Self-Propelled				
Amphibious Armor/Armored/Track				

Table 5-3. Field A: Branch and Functional Symbols

Description	Friend	Hostile	Neutral	Unknown
Amphibious Recovery Armor/Armored/Track				
Track Recovery				
Wheeled Armored				
Wheeled Armored Recovery				
Wheeled Armored Amphibious				
Wheeled Armored Amphibious Recovery				
Aviation				
Aviation Symbol: Rotary Wing				
<i>Fixed Wing</i>				
Fixed Wing Symbol: Shaded Propellor				
Fixed Wing Utility				
Fixed Wing Attack				
Fixed Wing Reconnaissance (Scout)				
<i>Rotary Wing</i>				
Rotary Wing Symbol: Shaded Rotor System				

Table 5-3. Field A: Branch and Functional Symbols

Description	Friend	Hostile	Neutral	Unknown
Rotary Wing Attack				
Rotary Wing Reconnaissance (Scout)				
Rotary Wing Air Cavalry				
Rotary Wing Antisubmarine Warfare (ASW)				
Rotary Wing Utility				
Rotary Wing Utility Light				
Rotary Wing Utility Medium				
Rotary Wing Utility Heavy				
Rotary Wing Command and Control (C2)				
Rotary Wing Medical Evacuation (MEDEVAC)				
Rotary Wing Mine Countermeasure (MCM)				
Rotary Wing Search & Rescue (SAR)				
Composite (Rotary Wing and Fixed Wing)				

Table 5-3. Field A: Branch and Functional Symbols





































Description	Friend	Hostile	Neutral	Unknown
<i>Vertical/Short Takeoff and Landing (V/STOL)</i>				
Vertical/Short Takeoff and Landing (V/STOL) Symbol: Abbreviation VSTOL for Vertical/Short Takeoff and Landing				
<i>Unmanned Aerial Vehicle</i>				
Unmanned Aerial Vehicle Symbol: UAV Wing				
Fixed Wing Unmanned Aerial Vehicle				
Rotary Wing Unmanned Aerial Vehicle				
Infantry				
Infantry Symbol: Crossed Straps				
Light Infantry				
Motorized Infantry				
Mountain Infantry				
Airborne Infantry				

Table 5-3. Field A: Branch and Functional Symbols









































Description	Friend	Hostile	Neutral	Unknown
Air Assault Infantry				
Mechanized or Armored Infantry				
Naval Infantry				
Mechanized/Armored Infantry with Gun System (Infantry Fighting Vehicle)				
Arctic Infantry				
Engineer				
Engineer Symbol: Bridge				
Engineer Bridging				
Combat Engineer				
Construction Engineer				
Diving Engineer				

Table 5-3. Field A: Branch and Functional Symbols





































Description	Friend	Hostile	Neutral	Unknown
Drilling Engineer				
Naval Engineer				
Topographic Engineer				
Field Artillery				
Field Artillery Symbol: Cannonball				
<i>Howitzer/Gun</i>				
Howitzer/Gun				
Self-Propelled Howitzer/Gun				
Amphibious Howitzer/Gun				
<i>Rocket Launchers</i>				
Single Rocket Launcher				
Single Rocket Launcher				
Self-Propelled Single Rocket Launcher				

Table 5-3. Field A: Branch and Functional Symbols









































Description	Friend	Hostile	Neutral	Unknown
Truck Mounted Single Rocket Launcher				
Towed Single Rocket Launcher				
<i>Multiple Rocket Launcher</i>				
Multiple Rocket Launcher				
Self-Propelled Multiple Rocket Launcher				
Truck Mounted Multiple Rocket Launcher				
Towed Multiple Rocket Launcher				
<i>Survey</i>				
Survey Symbol: Survey Control Point				
<i>Meteorological</i>				
Meteorological Symbol: Abbreviation for Meteorological				
<i>Target Acquisition</i>				
Target Acquisition Symbol: Abbreviation for Target Acquisition				
Sound				

Table 5-3. Field A: Branch and Functional Symbols









































Description	Friend	Hostile	Neutral	Unknown
Flash (Optical)				
Radar				
Reconnaissance (COLT/FIST)				
Tracked COLT/FIST				
ANGLICO				
Mortar				
Mortar Symbol: Mortar Equipment Symbol				
Self-Propelled/Tracked				
Towed				
Amphibious				
Reconnaissance, Cavalry, or Scouts				
Reconnaissance, Cavalry, or Scouts Symbol: Cavalry Bandoleer				

Table 5-3. Field A: Branch and Functional Symbols

Description	Friend	Hostile	Neutral	Unknown
Armored Cavalry (Armored Reconnaissance or Scouts)				
Marine Reconnaissance (Amphibious Reconnaissance)				
Marine Reconnaissance Division				
Marine Reconnaissance Force				
Wheeled Armored Reconnaissance				
Light Armored Reconnaissance (LAR)				
Long Range Surveillance (LRS)				
Surface-to-Surface Missiles				
Surface-to-Surface Missile Symbol: Surface-to-Surface Missile Equipment Symbol				
Tactical Surface-to-Surface Missile				
Strategic Surface-to-Surface Missile				

Table 5-3. Field A: Branch and Functional Symbols





































Description	Friend	Hostile	Neutral	Unknown
Internal Security Forces				
Internal Security Forces Symbol: Abbreviation for Internal Security Forces				
Riverine Internal Security Forces				
Railroad Internal Security Forces				
Aviation Internal Security Forces				
Combat Support Unit				
Combat Support Unit Symbol Abbreviation for Combat Support				
Nuclear, Biological, Chemical				
Nuclear, Biological, Chemical (NBC) Symbol: Crossed Retorts				
Nuclear, Biological, Chemical Decontamination				
<i>Chemical</i>				
Chemical Symbol: Abbreviation for Chemical				
Chemical Smoke and Decontamination				

Table 5-3. Field A: Branch and Functional Symbols

Description	Friend	Hostile	Neutral	Unknown
Chemical Smoke				
Chemical Reconnaissance				
Chemical Wheeled Armored Reconnaissance Surveillance				
Nuclear				
Nuclear Symbol: Symbol: Abbreviation for Nuclear				
Biological				
Biological Symbol: Abbreviation for Biological				
Motorized Biological Reconnaissance				
Military Intelligence				
Military Intelligence Symbol: Abbreviation for Military Intelligence				
Military Intelligence Aerial Exploitation				
Military Intelligence Signals Intelligence (SIGINT)				
Military Intelligence Counterintelligence				

Table 5-3. Field A: Branch and Functional Symbols

Description	Friend	Hostile	Neutral	Unknown
Military Intelligence Ground Surveillance Radar				
Military Intelligence Sensor				
Military Intelligence Sensor Control Module (SCM)				
Military Intelligence Ground Station Module (GSM)				
Military Intelligence Meteorological (MET)				
Military Intelligence Operations (OPS)				
Military Intelligence Tactical Exploitation (TE)				
Joint Intelligence Center				
Electronic Warfare				
Electronic Warfare Symbol: Abbreviation for Electronic Warfare				
Electronic Warfare Armored Wheeled Vehicle				
Electronic Warfare Direction Finding				
Electronic Warfare Intercept				

Table 5-3. Field A: Branch and Functional Symbols

















































Description	Friend	Hostile	Neutral	Unknown
Electronic Warfare Jamming				
Electronic Warfare Theater/Echelons Above Corps Support Element				
Electronic Warfare Corps Support Element				
Law Enforcement				
Military Police Symbol: Abbreviation for Military Police				
Criminal Investigation Division (CID)				
Shore Patrol Symbol: Abbreviation for Shore Patrol				
Civilian Law Enforcement				
Security Police (AIR)				
Signal				
Signal Symbol: Lightning Flash				
Signal Area				
Signal Communications Contingency Package (CCP)				
Signal Communications Contingency Package (CCP) Light (L)				

Table 5-3. Field A: Branch and Functional Symbols









































Description	Friend	Hostile	Neutral	Unknown
<i>Mobile Subscriber Element (MSE)</i>				
Signal Mobile Subscriber Element (MSE) Small Extension Node (SEN)				
Signal Mobile Subscriber Element (MSE) Large Extension Node (LEN)				
Signal Mobile Subscriber Element (MSE) Node Center (NC)				
Signal Mobile Subscriber Element (MSE) Radio Access Unit (RAU)				
Signal Tri-service Tactical Communications Single Shelter Switch (SSS)				
Signal Tri-service Tactical Communications AN/TTC-39D				
Signal Radio Unit Tactical Satellite				
Signal Radio Unit Teletype Center				
Signal Line of Sight Radio Relay				
Signal Enhanced Position Location Reporting System (EPLRS) Ground Reference Unit				

Table 5-3. Field A: Branch and Functional Symbols

































Description	Friend	Hostile	Neutral	Unknown
Information Operations				
Information Operations (IO) Symbol: Abbreviation for Information Operations				
Landing Support				
Landing Support				
Explosive Ordnance Disposal				
Explosive Ordnance Disposal (EOD) Symbol: Abbreviation for Explosive Ordnance Disposal				
Combat Service Support				
Combat Service Support (CSS) Symbol: Abbreviation for Combat Service Support				
Higher Echelon Support				
Theater/Echelons Above Corps Support Element				
Corps Support Element				
Multifunctional Combat Service Support				
Administrative				
Administrative (ADM) Symbol: Abbreviation for Administration				
Administrative Theater/Echelons Above Corps Support Element				

Table 5-3. Field A: Branch and Functional Symbols













































Description	Friend	Hostile	Neutral	Unknown
Administrative Corps Support Element				
Judge Advocate General (JAG) Symbol: Abbreviation for Judge Advocate General				
Postal Symbol: Postal Horn				
Finance Symbol: Strong Box				
Personnel Services (PS) Symbol: Abbreviation for Personnel Services				
Mortuary/Graves Registry Symbol: Casket with Cross				
Religious Support (Chaplain) Symbol: Abbreviation for Religious Support				
Band Symbol: Band				
Public Affairs (PA) Symbol: Abbreviation for Public Affairs				
Broadcast Public Affairs Detachment				
Joint Information Bureau (JIB)				

Table 5-3. Field A: Branch and Functional Symbols









































Description	Friend	Hostile	Neutral	Unknown
Replacement Holding Unit (RHU) Symbol: Abbreviation for Replacement Holding Unit				
Labor Symbol: Shovel				
Morale, Welfare, Recreation (MWR) Symbol: Abbreviaion for Morale, Welfare, Recreation				
Medical				
Medical Symbol: Geneva Cross				
Medical Treatment Facility				
Veterinary Symbol: Abbreviation for Veterinary				
Dental Symbol: Abbreviation for Dental				
Psychological Symbol: Abbreviation for Psychological				
Fixed Wing Medical Evacuation				
Rotary Wing Medical Evacuation				

Table 5-3. Field A: Branch and Functional Symbols









































Description	Friend	Hostile	Neutral	Unknown
Supply				
Supply				
Supply Trains				
Quartermaster (Supply) Symbol: Key to Stores				
Class I: Subsistence NATO Class I				
Class II: Clothing and Equipment NATO Class II Symbol: Key to Stores				
Class III: POL NATO Class III Symbol: Funnel				
Class III: OL Aviation NATO Class III				
Class IV: Construction Materials NATO Class IV Symbol: Engineer Bridge				
Class V: Ammunition NATO Class V Symbol: Shell				
Class VI: Personal Demand Items NATO Class I Symbol: Person				

Table 5-3. Field A: Branch and Functional Symbols

Description	Friend	Hostile	Neutral	Unknown
Class VII: Major End Items NATO Class II				
Class VIII: Medical NATO Class II Symbol: Geneva Cross				
Class IX: Repair Parts NATO Class II Symbol: Ordnance Bursting Bomb				
Class X: Nonstandard Items NATO Class IV Symbol: Abbreviation for Civil Affairs				
Laundry/Bath Symbol: Shower Head				
Water Symbol: Faucet				
Water Purification				
Transportation				
Transportation Symbol: Wheel				
Movement Control Center (MCC)				
Railhead				

Table 5-3. Field A: Branch and Functional Symbols

































Description	Friend	Hostile	Neutral	Unknown
Seaport of Debarcation/Seaport of Embarkation (SPOD/SPOE)				
Aerial Port of Debarcation/Aerial Port of Embarkation (APOD/APOE)				
Maintenance				
Maintenance Symbol: Double Wrench				
Maintenance Heavy				
Maintenance Electro-Optical				
Maintenance Recovery				
Maintenance Ordnance				
Maintenance Missile Ordnance				

Table 5-4. Field A: Mobility and Capability Modifiers



Description	Symbol
Air Assault Symbol: Elongated V	 A blue square containing a white elongated V shape.
Air Assault with Organic Lift Symbol: Elongated V with Stem	 A blue square containing a white elongated V shape with a vertical stem extending downwards from its center.
Air Assault with Organic Lift (NATO)	 A blue square containing a white inverted V shape at the bottom, with a thin horizontal line above it.
Airborne Symbol: Gull's Wings	 A blue square containing a white curved line resembling the wings of a gull.
Amphibious Symbol: Waves	 A blue square containing a white wavy line representing water waves.
Arctic Symbol: Ski/Runner	 A blue square containing a white curved line resembling a ski or a runner's foot.

Table 5-4. Field A: Mobility and Capability Modifiers



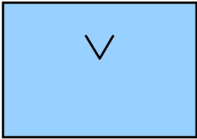
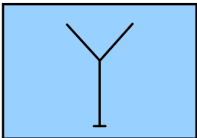
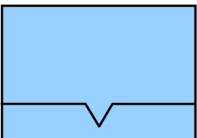

Description	Symbol
Bicycle Equipped	
Gun System	
Horse, Camel, or Pack Animal Equipped	
Light/Low Altitude Symbol: Abbreviation for Light or Low	
Medium/Medium Altitude Symbol: Abbreviation for Medium	
Heavy/High Altitude Symbol: Abbreviation for Heavy or High	

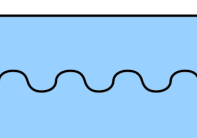
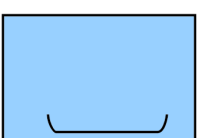
Table 5-4. Field A: Mobility and Capability Modifiers

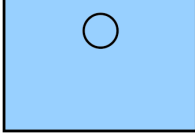

Description	Symbol
Mechanized, Armored, or Self-Propelled (Tracked) Symbol: Tank Track	
Armored (Wheeled) Symbol: Armored with Wheels	
Motorized	
Mountain Symbol: Shaded Mountain	
Naval Symbol: Anchor	
Railway Symbol: Flat Bed Railcar	

Table 5-4. Field A: Mobility and Capability Modifiers

Description	Symbol
Reconnaissance Symbol: Cavalry Bandoleer	
Recovery Symbol: Double End Wrench	
Riverine or Floating Symbol: Barge	
Ski Symbol: Crossed Ski Poles	
Towed Symbol: Trailer	

Table 5-5. Field A: Special Operations Forces

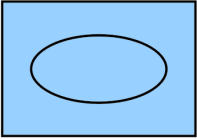
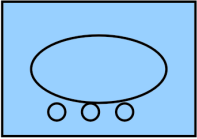
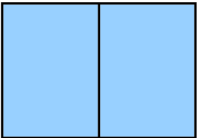
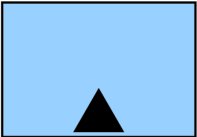

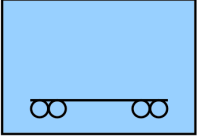



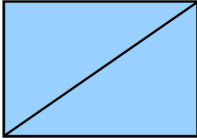
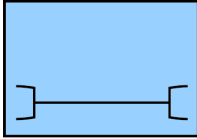
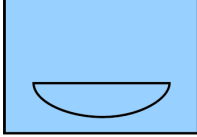
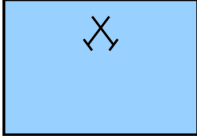
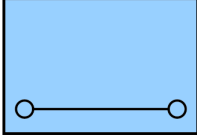





























Special Operations Forces (SOF) Unit Symbols	Friend	Hostile	Neutral	Unknown
Special Operations Forces (SOF) Symbol: Abbreviation for Special Operations Forces				
Aviation				
Fixed Wing				
Fixed Wing Attack				
Fixed Wing Refuel				
Fixed Wing Utility				
V/STOL				
Rotary Wing				
Rotary Wing Combat Search and Rescue				

Table 5-5. Field A: Special Operations Forces

















































Special Operations Forces (SOF) Unit Symbols	Friend	Hostile	Neutral	Unknown
Rotary Wing Attack				
Rotary Wing Utility				
Naval				
Sea-Air-Land Team (SEAL) Symbol: Abbreviation for Sea-Air-Land				
Special Boat				
Special Attack Submarine Nuclear and Radiological (SSNR)				
Army Special Forces Symbol: Abbreviation for Special Forces				
Ranger				
Psychological Operations (PSYOP) Symbol: Loud Speaker				

Table 5-5. Field A: Special Operations Forces

Special Operations Forces (SOF) Unit Symbols	Friend	Hostile	Neutral	Unknown
Fixed Wing Aviation Psychological Operations				
Civil Affairs Symbol: Abbreviation for Civil Affairs				
Support				

FIELD B: ECHELON

5-4. An echelon is a separate level of command. As compared to a regiment, a division is a higher echelon, a battalion is a lower echelon. (NATO)

Table 5-6. Field B: Echelon

<i>Echelon</i>	<i>Symbol</i>
Team ¹ /Crew	∅
Squad ²	•
Section ³	••
Platoon ⁴ /Detachment	•••
Company ⁵ /Battery ⁶ /Troop ⁷	
Battalion ⁸ /Squadron	
Regiment ⁹ /Group ¹⁰	
Brigade ¹¹	X
Division ¹²	XX
Corps ¹³	XXX
Army ¹⁴	XXXX
Army Group ¹⁵	XXXXX
Region ¹⁶	XXXXXX

Notes:

¹Team: The smallest formation.

²Squad: A formation larger than a team, but smaller than a section.

³Section: A formation larger than a squad, but smaller than a platoon.

⁴Platoon: A formation larger than a section, but smaller than a company.

⁵Company: A formation larger than a platoon, but smaller than a battalion. A unit consisting of two or more platoons, usually of the same type, with a headquarters and a limited capacity for self-support.

⁶Battery: Tactical and administrative artillery unit or subunit corresponding to a company or similar unit in other branches of the Army. (NATO)

⁷Troop: Tactical and administrative cavalry unit or subunit corresponding to a company or similar unit in other branches of the Army.

⁸Battalion: A formation larger than a company, but smaller than a regiment. A unit consisting of two or more company-, battery-, or troop-sized units and a headquarters.

⁹Regiment: A formation larger than a battalion, but smaller than a brigade. (Army)—A single or a group of like-type combat arms or training units authorized a regimental color.

¹⁰Group: A flexible administrative and tactical unit composed of either two or more battalions or two or more squadrons. The term also applies to combat support or combat service support units.

¹¹Brigade: A formation larger than a regiment, but smaller than a division. (Joint)—A unit usually smaller than a division to which are attached groups and/or battalions and smaller units tailored to meet anticipated requirements. (Army)—A unit consisting of two or more battalions and a headquarters.

¹²Division: A major administrative and tactical unit/formation which combines in itself the necessary arms and services required for sustained combat, larger than a regiment/brigade and smaller than a corps. (NATO). (Army)—The largest fixed organization in the Army that trains and fights as a tactical team and is organized with varying numbers and types of combat, combat support, and combat service support units.

¹³Army Corps: A formation larger than a division but smaller than an army or army group. It usually consists of two or more divisions together with supporting arms and services. (NATO). The Army's largest tactical unit and the instrument by which higher echelons of command conduct maneuver at the operational level.

¹⁴Army: A formation larger than an army corps, but smaller than an army group. It usually consists of two or more army corps. (NATO)

¹⁵Army Group: The largest formation of land forces, normally comprising two or more armies or army corps under a designated commander. (NATO)

¹⁶Region: This usually refers to the area of a geographical combatant commander, such as JFCOM, EUCOM, PACOM, SOUTHCOM, NORTHCOM, and CENTCOM.

5-5. There is also a separate echelon known as a command. A command is a unit or units, an organization, or an area under the command of one individual. It does not correspond to any of the other echelons. It is designated by using ++ as its echelon symbol (see figure 5-3).

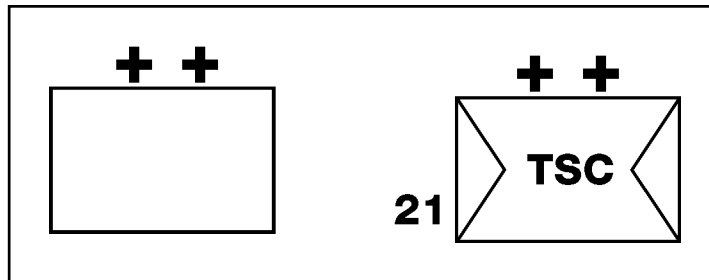

Figure 5-3. Examples of Command Symbols

FIELD D: TASK FORCE

5-6. A task force is a temporary grouping of units, under one commander, formed for carrying out a specific operation or mission or a semi-permanent organization of units, under one commander, formed for the purpose of carrying out a continuing specified task (see figure 5-4).

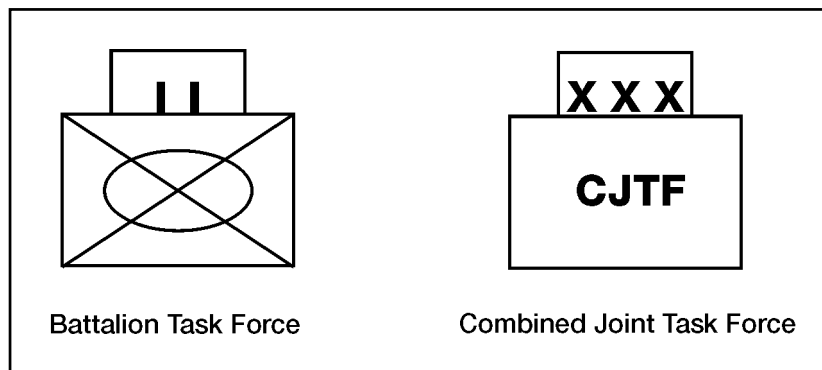

Figure 5-4. Examples of Task Forces

FIELD F: REINFORCED OR DETACHED

5-7. These symbols are used at division and below levels. The reinforced symbol + indicates that the capability of one unit has been augmented by the capability of another unit. The reduced symbol – indicates that the capability of a unit has been reduced by the detachment of one or more of its units. If a unit has been both reinforced and reduced, then the ± symbol is used (see figure 5-5).

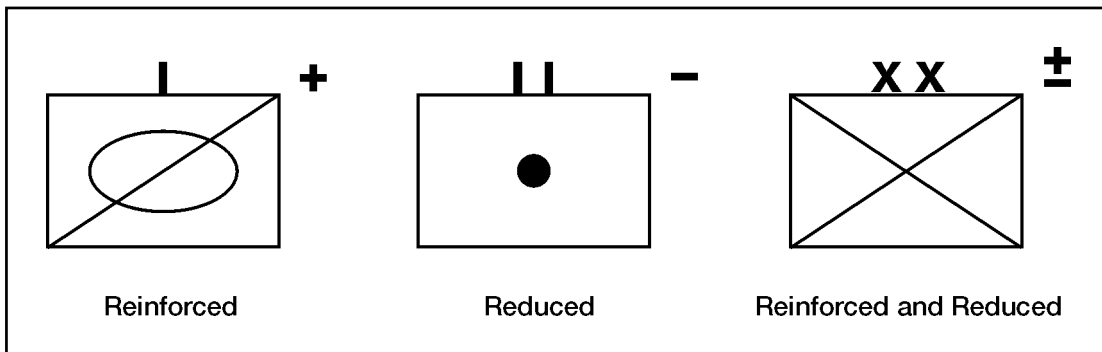

Figure 5-5. Examples of Reinforced, Reduced, and Reinforced and Reduced

Table 5-7. Field AA: Named Command and Control Headquarters

Description	Symbol
Army Service Component Commands (ASCC)	
United States Army Europe USAREUR	<p style="text-align: center;">XXXX</p> <div style="border: 1px solid black; padding: 2px; width: fit-content; margin: 0 auto;">USAREUR</div>
United States Army Forces Command FORSCOM	<p style="text-align: center;">XXXX</p> <div style="border: 1px solid black; padding: 2px; width: fit-content; margin: 0 auto;">FORSCOM</div>
United States Army Pacific USARPAC	<p style="text-align: center;">XXXX</p> <div style="border: 1px solid black; padding: 2px; width: fit-content; margin: 0 auto;">USARPAC</div>
United States Army South USARSO	<p style="text-align: center;">XXXX</p> <div style="border: 1px solid black; padding: 2px; width: fit-content; margin: 0 auto;">USARSO</div>
United States Army Central ARCENT	<p style="text-align: center;">XXXX</p> <div style="border: 1px solid black; padding: 2px; width: fit-content; margin: 0 auto;">ARCENT</div>
Armies	
Third United States Army TUSA	<p style="text-align: center;">XXXX</p> <div style="border: 1px solid black; padding: 2px; width: fit-content; margin: 0 auto;">TUSA</div>
Eighth United States Army EUSA	<p style="text-align: center;">XXXX</p> <div style="border: 1px solid black; padding: 2px; width: fit-content; margin: 0 auto;">EUSA</div>

Table 5-7. Field AA: Named Command and Control Headquarters

Description	Symbol
Combatant Commands	
United States Central Command CENTCOM	XXXXXX <div style="border: 1px solid black; padding: 2px; display: inline-block;">CENTCOM</div>
United States European Command EUCOM	XXXXXX <div style="border: 1px solid black; padding: 2px; display: inline-block;">EUCOM</div>
United States Joint Forces Command JFCOM	XXXXXX <div style="border: 1px solid black; padding: 2px; display: inline-block;">JFCOM</div>
United States Pacific Command PACOM	XXXXXX <div style="border: 1px solid black; padding: 2px; display: inline-block;">PACOM</div>
United States Northern Command NORTHCOM	XXXXXX <div style="border: 1px solid black; padding: 2px; display: inline-block;">NORTHCOM</div>
United States Southern Command SOUTHCOM	XXXXXX <div style="border: 1px solid black; padding: 2px; display: inline-block;">SOUTHCOM</div>
Alliance Commands	
Supreme Headquarters Allied Powers Europe SHAPE	XXXXXX <div style="border: 1px solid black; padding: 2px; display: inline-block;">SHAPE</div>
Supreme Allied Command Atlantic SACLANT	XXXXXX <div style="border: 1px solid black; padding: 2px; display: inline-block;">SACLANT</div>

Table 5-7. Field AA: Named Command and Control Headquarters

Description	Symbol
Generic Joint and Multinational Commands	
Joint Force Land Component Command JFLCC	<div style="border: 1px solid black; padding: 5px; display: inline-block;"> JFLCC </div>
Joint Force Maritime Component Command JFMCC	<div style="border: 1px solid black; padding: 5px; display: inline-block;"> JFMCC </div>
Joint Force Air Component Command JFACC	<div style="border: 1px solid black; padding: 5px; display: inline-block;"> JFACC </div>
Joint Force Special Operations Component Command JFSOCC	<div style="border: 1px solid black; padding: 5px; display: inline-block;"> JFSOCC </div>
Joint Task Force JTF	<div style="border: 1px solid black; padding: 5px; display: inline-block;"> JTF </div>
Multinational Joint Task Force MNJTF	<div style="border: 1px solid black; padding: 5px; display: inline-block;"> MNJTF </div>

Table 5-8. Field AJ: Headquarters Element







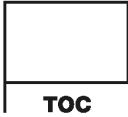

Description	Symbol
Tactical Operations Center TOC	
Assault Command Post ASLT	
Base Defense Operations Center BDOC	
Command Group CMD	
Combat Trains Command Post CTCP	
Forward Trains Command Post FTCP	
Forward Command Post FWD	
Main Command Post MAIN	
Rear Command Post REAR	
Tactical Command Post TAC	

Table 5-9. Multifunctional Combat Service Support Units



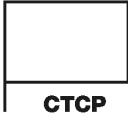
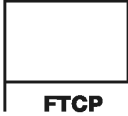



Description	Symbol
Theater/Echelons Above Corps Multifunctional Combat Service Support	
Theater Support Command TSC	<p style="text-align: center;">+ +</p> 
Theater Army Area Command TAACOM	<p style="text-align: center;">+ +</p> 
Area Support Group ASG	<p style="text-align: center;">III</p> 
Area Support Battalion ASB	<p style="text-align: center;">II</p> 
Corps Level Multifunctional Combat Service Support	
Corps Support Command COSCOM	<p style="text-align: center;">X X</p> 
Corps Support Group (Forward) CSG(F)	<p style="text-align: center;">III</p> 
Corps Support Group (Rear) CSG(R)	<p style="text-align: center;">III</p> 

Table 5-9. Multifunctional Combat Service Support Units

Description	Symbol
Force Service Support Group FSSG	
Corps Support Battalion CSB	
Division Level and Below Multifunctional Combat Service Support	
Division Support Command DISCOM	
Division Aviation Support Battalion DASB	
Main Support Battalion MSB	
Forward Support Battalion FSB	

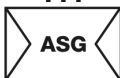
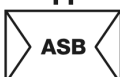
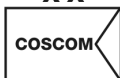
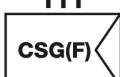
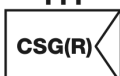
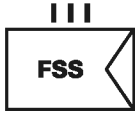
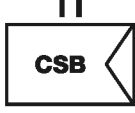
LOCATING UNIT SYMBOLS

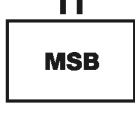
5-8. The center of mass of the unit symbol indicates the general vicinity of the center of mass of the unit. To indicate precise location or reduce clutter in an area with multiple units, a line (without an arrow) extends from the center of the bottom of the frame to the unit location displayed as field Q. The line may be extended or bent as required. If a group of units (or installations) other than a headquarters is at one location, the grouping of the symbols may be enclosed with a bracket and the exact location indicated by a line from the center of the bracket (see figure 5-6).

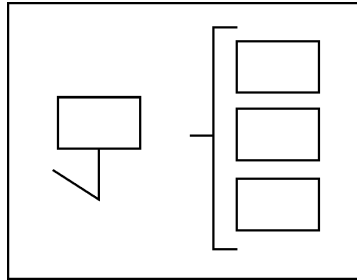

Figure 5-6. Offset and Multiple Unit Locations

5-9. Headquarters unit symbols include a staff or line drawn from the bottom left hand corner displayed as field "S." This staff may be bent or extended as required to indicate unit location. If several headquarters are at one location, more than one headquarters can be on a single staff. The highest echelon headquarters is placed on top, followed by the next levels in descending order (see figure 5-7).

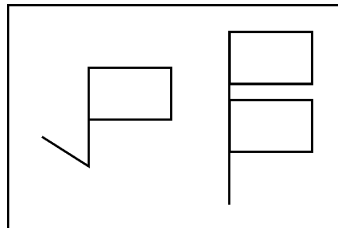

Figure 5-7. Offset Headquarters and Multiple Headquarters Locations

Chapter 6

Equipment Symbols

This chapter establishes a single standard for the development of equipment symbols. It describes procedures for creating composite weapon system symbols and the procedures for text labeling to provide necessary details.

ORIENTATION OF EQUIPMENT SYMBOLS

6-1. Orientation of the symbols shown in this chapter is extremely important. All manual and automated displays and overlays should show the symbol oriented the same as the actual equipment. The “Q” field shows the orientation of moving equipment symbols. On color displays, blue or black represent friendly equipment, while red represents hostile equipment. Monochrome displays use the color available.

COMPOSITION OF EQUIPMENT SYMBOLS

6-2. An equipment symbol is composed of a frame, color (fill), equipment symbol (icon), and text or graphic modifiers (see figure 6-1). (See table 6-1 for the steps used to build equipment symbols.)

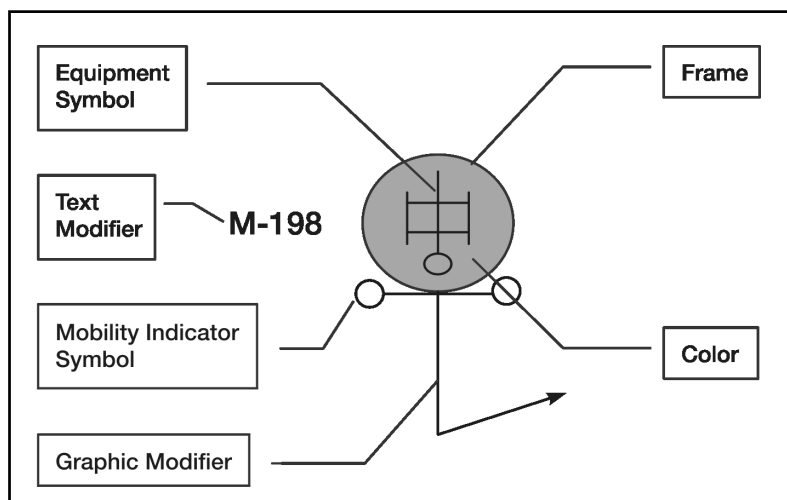

Figure 6-1. Equipment Symbol Components

BUILDING EQUIPMENT SYMBOLS

Note: The use of symbol frames, shown in table 6-1, is optional for equipment and recommended only for ships, aircraft, and aerial vehicles or monochrome screens.

Table 6-1. Building Equipment Symbols with Frames







Step #	Step	Example					
Step 1.	First choose the frame that matches the affiliation of the equipment (friendly, hostile, neutral). Then choose the basic equipment symbol for field "A." In this example, the affiliation is friendly and the equipment is a howitzer. (See the following land equipment frame shapes and affiliations; see also figure 6-2, page 6-4; table 6-3, page 6-4; and table 6-4, page 6-7.)	 <p>Friendly Howitzer</p>					
Land Equipment Frame Shapes and Affiliation							
Affiliation	Friendly	Hostile	Neutral	Unknown	Pending	Assumed Friend	Suspect
Frame							
Step 2.	Choose the size/range equipment symbol modifier that further explains the capability of that equipment, modifying field "A." In this example, the equipment symbol modifier is medium (bolded). (See table 6-4, page 6-7, and table 6-6, page 6-31.)	 <p>Friendly Medium Howitzer</p>					
Step 3.	Choose the mobility indicator modifier for the next capability, for field "R." In this example, the mobility indicator is self-propelled or tracked (bolded). (See table 6-5, page 6-29.)	 <p>Friendly Medium Self-Propelled Howitzer</p>					

Table 6-1. Building Equipment Symbols with Frames

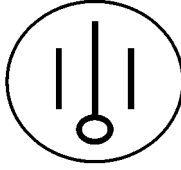

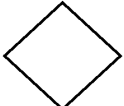
Step #	Step	Example
Step 4.	Choose text modifiers as necessary to provide further amplifying information. In this example, the text modifier is the type of equipment (field "V"), or M109A6, and the common identifier (field "AF"), or Paladin. (See table 6-3, page 6-4.)	<p>M109A6/Paladin </p> <p>Friendly (M109A6 Paladin) Medium Self-Propelled Howitzer</p>

Table 6-2. Building Equipment Symbols Without Frames

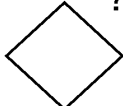
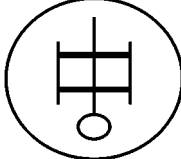
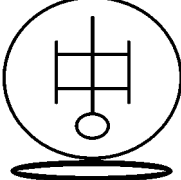
Step #	Step	Example
Step 1.	First choose the basic equipment symbol for field "A." In this example, the affiliation is friendly (black) and the equipment is a tank. (See table 6-4, page 6-19.)	 <p>Tank</p>
Step 2.	Choose the size/range equipment symbol modifier that further explains the capability of that equipment, modifying field "A." In this example, the equipment symbol modifier is heavy. (See table 6-4, page 6-20, and table 6-6, page 6-31.)	 <p>Heavy Tank</p>
Step 3.	If required, choose the mobility indicator modifier for the next capability, for field "R." In this example, there is no requirement for a mobility indicator.	 <p>Heavy Tank</p>
Step 4.	Choose text modifiers as necessary to provide further amplifying information. In this example, the text modifier is the type of equipment (field "V"), or M1A2, and the common identifier (field "AF"), or Abrams. (See table 6-3, page 6-4.)	<p>M1A2/Abrams </p> <p>Friendly M1A2 (Abrams) Heavy Tank</p>

EQUIPMENT SYMBOL MODIFIER FIELDS

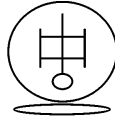
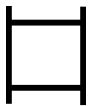
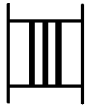
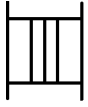
6-3. Figure 6-2 shows the placement of equipment labeling fields around the friendly land equipment symbol frame. The placement of equipment symbol modifier fields is the same regardless of frame shape or affiliation.

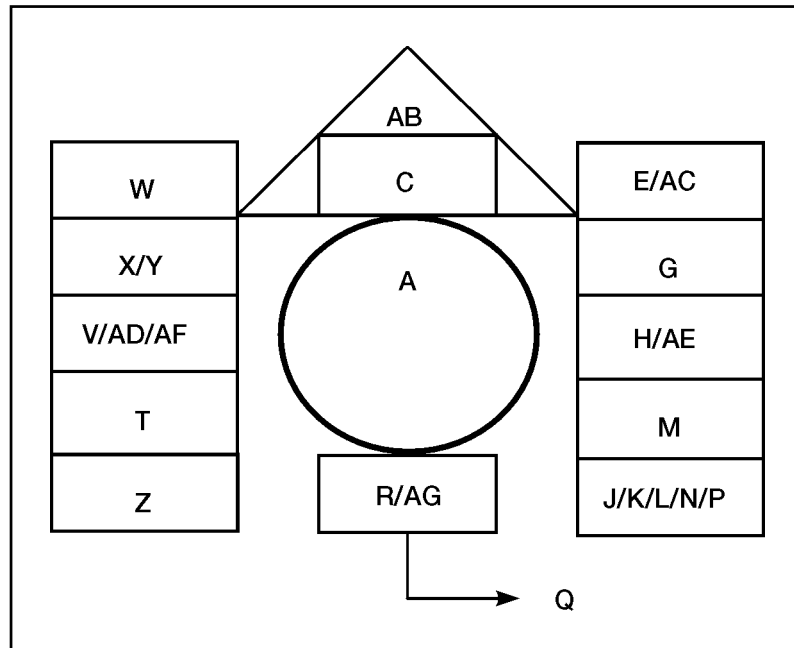

Figure 6-2. Equipment Symbol Modifier Fields

6-4. Table 6-3 provides a description of each of the equipment symbol modifier fields as shown in figure 6-2. See appendix B for examples of equipment symbols with multiple fields that are filled in.

Table 6-3. Descriptions of Fields for Text or Graphic Modifiers for Equipment Symbols

<i>Field</i>	<i>Field Title</i>	<i>Description</i>	<i>Text/Graphic</i>
A	Symbol	Basic equipment symbol that can include size or capacity modifiers. (See table 6-4, page 6-7, and table 6-5, page 6-29.)	Both
C	Quantity	Identifies the number of items present.	Text
E	Frame Shape Modifier	Helps determine affiliation or battle dimension of symbol. "U" represents unknown battle dimension. Question mark "?" represents suspect or assumed friend.	Text
G	Staff Comments	Free text. Can be used by staff for information required by commander.	Text
H	Additional Information	Free text. Additional information not covered by other fields.	Text

Table 6-3. Descriptions of Fields for Text or Graphic Modifiers for Equipment Symbols

<i>Field</i>	<i>Field Title</i>	<i>Description</i>	<i>Text/Graphic</i>
J	Evaluation Rating	<p>Degree of confidence that may be placed on the information represented by the symbol. It is shown as one letter and one number made up of Reliability of Source and Credibility of Information.</p> <p>Reliability of Source:</p> <p>A. Completely reliable B. Usually reliable C. Fairly reliable D. Not usually reliable E. Unreliable F. Reliability cannot be judged.</p> <p>Credibility of Information:</p> <p>1. Confirmed by other sources 2. Probably true 3. Possibly true 4. Doubtful 5. Improbable 6. Truth cannot be judged.</p>	Text
K	Combat Effectiveness	<p>Effectiveness of unit or equipment displayed.</p> <p>1. Fully Operational 2. Substantially Operational 3. Marginally Operational 4. Not Operational</p>	Text
L	Signature Equipment	Identifies a detectable electronic signature "!" for hostile equipment.	Text
M	Higher Formation	Number or title of higher echelon command of equipment being displayed.	Text
P	Identification Friend or Foe (IFF)/Selective Identification Feature (SIF)	IFF/SIF identification modes and codes.	Text
Q	Direction of Movement Arrow/Offset Location Indicator	With arrow, it denotes the direction symbol is moving or will move. Without arrow, it is used to denote precise location or to declutter.	Graphic
R	Mobility Indicator	Pictorial representation of the mobility of the symbol.	Graphic

Table 6-3. Descriptions of Fields for Text or Graphic Modifiers for Equipment Symbols

<i>Field</i>	<i>Field Title</i>	<i>Description</i>	<i>Text/Graphic</i>
T	Unique Designation	An alphanumeric designator that uniquely identifies a particular model of equipment (number).	Text
V	Type of Equipment	Identifies unique designation (such as AH-64 for attack helicopter).	Text
W	Date-Time Group	An alphanumeric designator for displaying a date-time group (DDHHMMSSZMONYY) or "O/O" for on order. The date-time group is composed of a group of six numeric digits with a time zone suffix and the standardized three-letter abbreviation for the month, followed by two digits. The first pair of digits represents the day; the second pair, the hour; the third pair, the minutes. The last two digits of the year are after the month. For automated systems, two digits may be added before the time zone suffix and after the minutes to designate seconds.	Text
X	Altitude/Depth	Height in feet of equipment or structure on the ground.	Text
Y	Location	Latitude and longitude; grid coordinates.	Text
Z	Speed	Displays speed in nautical miles per hour or kilometers per hour.	Text
AB	Dummy Indicator	Indicates that the equipment is a dummy.	Graphic
AC	Country Indicator	A two-letter code that indicates the country of origin of the unit. This field can be used also for factions or groups in crisis response operations. (Names of factions, groups, must be spelled out.)	Text
AD	Platform Type	ELNOT or CENOT	Text
AE	Equipment Teardown Time	Equipment teardown time in minutes.	Text
AF	Common Identifier	Example: Patriot for air defense missile launcher.	Text
AG	Auxiliary Equipment Indicator	Indicates the presence of a towed sonar array.	Graphic

Table 6-4. Field A: Equipment Types

Equipment Types	Friend	Hostile	Neutral	Unknown
Equipment The use of frame shapes is optional for equipment and recommended only for ships, aircraft, and aerial vehicles.				
Weapon System The use of a shaft indicates a weapon system.				
Missile Launchers				
Missile Launcher The use of a dome covering the entire shaft indicates a missile launcher.				
Air Defense (AD) Missile Launcher Surface-to-Air (SAM) The use of a closed radar dome at the base of the shaft indicates the weapon system is primarily for air defense.				
Air Defense Missile Launcher Short Range				

Table 6-4. Field A: Equipment Types









































Equipment Types	Friend	Hostile	Neutral	Unknown
Air Defense Missile Launcher Intermediate/Medium Range				
				
Air Defense Missile Launcher Long Range				
				
Air Defense Missile Launcher Theater				
				
Missile Launcher Surface-to-Surface (SSM)				
				
Surface-to-Surface Missile Launcher Short Range				
				

Table 6-4. Field A: Equipment Types









































Equipment Types	Friend	Hostile	Neutral	Unknown
Surface-to-Surface Missile Launcher Intermediate/Medium Range				
				
Surface-to-Surface Missile Launcher Long Range				
				
Missile Launcher Antitank (AT) The use of an upside down V at the base of the shaft indicates the weapon system is primarily antitank.				
				
Antitank Missile Launcher Light				
				
Antitank Missile Launcher Medium				
				

Table 6-4. Field A: Equipment Types

Equipment Types	Friend	Hostile	Neutral	Unknown
Antitank Missile Launcher Heavy				
Rocket Launchers				
Single Rocket Launcher The double arrowheads at the top of the shaft indicates a rocket launcher.				
Single Rocket Launcher Light				
Single Rocket Launcher Medium				
Single Rocket Launcher Heavy				

Table 6-4. Field A: Equipment Types

Equipment Types	Friend	Hostile	Neutral	Unknown
Multiple Rocket Launcher The double arrowheads at the top of the shaft indicate a rocket launcher. In addition, the use of parallel lines on both sides of the shaft indicates a multiple rocket launcher.				
Multiple Rocket Launcher Light				
Multiple Rocket Launcher Medium				
Multiple Rocket Launcher Heavy				
Antitank Rocket Launcher The use of an upside down V at the base of the shaft indicates the weapon system is primarily antitank.				

Table 6-4. Field A: Equipment Types









































Equipment Types	Friend	Hostile	Neutral	Unknown
Antitank Rocket Launcher Light				
				
Antitank Rocket Launcher Medium				
				
Antitank Rocket Launcher Heavy				
				
Automatic Weapons				
Rifle/Automatic Weapon				
				
Rifle/Automatic Weapon Rifle				
				

Table 6-4. Field A: Equipment Types









































Equipment Types	Friend	Hostile	Neutral	Unknown
Rifle/Automatic Weapon Light Machine Gun				
				
Rifle/Automatic Weapon Heavy Machine Gun				
				
Grenade Launchers				
Grenade Launcher The circle in the center of the shaft indicates a grenade launcher.				
				
Grenade Launcher Light				
				
Grenade Launcher Medium				
				

Table 6-4. Field A: Equipment Types

Equipment Types	Friend	Hostile	Neutral	Unknown
Grenade Launcher Heavy				
Mortars				
Mortar The circle at the base of the shaft indicates a high trajectory, indirect fire weapons system.				
Mortar Light				
Mortar Medium				
Mortar Heavy				

Table 6-4. Field A: Equipment Types

Equipment Types	Friend	Hostile	Neutral	Unknown
Howitzers				
<p>Howitzer</p> <p>The circle at the base of the shaft indicates a high trajectory, indirect fire weapons system. In addition, the use of parallel lines on both sides of the shaft indicates a howitzer.</p>				
<p>Howitzer Light</p>				
<p>Howitzer Light Self-Propelled</p>				
<p>Howitzer Medium</p>				
<p>Howitzer Medium Self-Propelled</p>				

Table 6-4. Field A: Equipment Types

Equipment Types	Friend	Hostile	Neutral	Unknown
Howitzer Heavy				
Howitzer Heavy Self-Propelled				
Gun Systems				
Air Defense Gun A closed radar dome at the base of the shaft indicates the weapon system is used primarily for air defense.				
Air Defense Gun Light				
Air Defense Gun Medium				

Table 6-4. Field A: Equipment Types

Equipment Types	Friend	Hostile	Neutral	Unknown
Air Defense Gun Heavy				
Antitank Gun The use of an upside down V at the base of the shaft indicates the weapon system is primarily antitank.				
Antitank Gun Light				
Antitank Gun Medium				
Antitank Gun Heavy				

Table 6-4. Field A: Equipment Types









































Equipment Types	Friend	Hostile	Neutral	Unknown
Gun Recoiless				
				
Direct Fire Gun				
				
Direct Fire Gun Light				
				
Direct Fire Gun Light Self-Propelled				
				
Direct Fire Gun Medium				
				

Table 6-4. Field A: Equipment Types









































Equipment Types	Friend	Hostile	Neutral	Unknown
Direct Fire Gun Medium Self-Propelled				
				
Direct Fire Gun Heavy				
				
Direct Fire Gun Heavy Self-Propelled				
				
Armored Vehicles				
Armored Protected Ground Vehicle				
				
Armored Tank				
				

Table 6-4. Field A: Equipment Types









































Equipment Types	Friend	Hostile	Neutral	Unknown
Tank Light				
				
Tank Light Recovery				
				
Tank Medium				
				
Tank Medium Recovery				
				
Tank Heavy				
				

Table 6-4. Field A: Equipment Types









































Equipment Types	Friend	Hostile	Neutral	Unknown
Tank Heavy Recovery				
				
Armored Personnel Carrier				
				
Armored Personnel Carrier Recovery				
				
Armored Combat Service Support (CSS) Vehicle				
				
Armored Fighting Vehicle (Infantry Fighting Vehicle)				
				

Table 6-4. Field A: Equipment Types









































Equipment Types	Friend	Hostile	Neutral	Unknown
Armored Fighting Vehicle Command and Control (C2)				
				
Armored Wheeled Fighting Vehicle				
				
Utility Vehicles				
Utility Vehicle Cargo or Personnel Carrier				
				
Utility Vehicle Bus				
				
Utility Vehicle Semi (Tractor Trailer)				
				

Table 6-4. Field A: Equipment Types









































Equipment Types	Friend	Hostile	Neutral	Unknown
Utility Vehicle Limited Cross-Country Truck				
				
Utility Vehicle Cross-Country Truck				
				
Utility Vehicle Limited Cross-Country Truck/Amphibious				
				
Engineer Vehicles				
Engineer Vehicle				
				
Engineer Vehicle Bridge				
				

Table 6-4. Field A: Equipment Types









































Equipment Types	Friend	Hostile	Neutral	Unknown
Engineer Vehicle Earthmover				
				
Engineer Vehicle Construction Vehicle				
				
Engineer Vehicle Mine Laying Vehicle				
				
Engineer Vehicle Armored Carrier Mine Laying Vehicle				
				
Engineer Vehicle Truck Mounted Mine Laying Vehicle				
				

Table 6-4. Field A: Equipment Types









































Equipment Types	Friend	Hostile	Neutral	Unknown
Engineer Vehicle Mine Clearing Vehicle Armored Vehicle Mounted				
				
Engineer Vehicle Mine Clearing Vehicle Trailer Mounted				
				
Engineer Vehicle Dozer				
				
Train Locomotive				
				
Railcar				
				

Table 6-4. Field A: Equipment Types





































Equipment Types	Friend	Hostile	Neutral	Unknown
Civilian Vehicle				
	CIV	CIV	CIV	CIV
Sensors				
Sensor				
				
Sensor Emplaced				
				
Radar				
				
Helicopters				
Utility Helicopter				
				

Table 6-4. Field A: Equipment Types













































Equipment Types	Friend	Hostile	Neutral	Unknown
Cargo Helicopter				
				
Reconnaissance Helicopter				
				
Attack/Armed Helicopter				
				
Special				
Laser				
				
NBC Equipment				
				
Smoke Generator				

Table 6-4. Field A: Equipment Types

































Equipment Types	Friend	Hostile	Neutral	Unknown
Flame Thrower				
				
Land Mines				
				
Land Mines Claymore				
				
Land Mines Less Than Lethal				
				

Table 6-5. Field R: Mobility Indicator











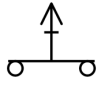





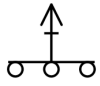





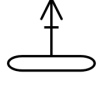





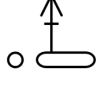



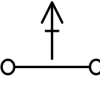

Mobility Symbol	Unframed	Friend	Hostile	Neutral	Unknown
Wheeled (Limited Cross-Country)					
					
Wheeled (Cross-Country)					
					
Tracked					
					
Wheeled and Tracked					
					
Towed					
					
Railway					
					

Table 6-5. Field R: Mobility Indicator

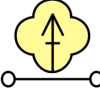
Mobility Symbol	Unframed	Friend	Hostile	Neutral	Unknown
Over-Snow (Prime Mover)					
Sled					
Pack Animals					
Barge					
Amphibious					

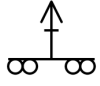
SIZE AND RANGE INDICATORS

6-5. In building equipment symbols, horizontal or vertical lines are added for size and range indicators. If an equipment symbol has no lines, it is a basic equipment symbol. Adding one line designates it as light or short-range. Adding two lines designates it as medium or medium-range. Finally, adding three lines designates it as heavy or long-range. If a system is designated as greater than heavy or long-range, heavy or long-range indicators will be used.

Table 6-6. Standards for Size and Range Indicators by Equipment Systems

System	Standard Weight/Range/Caliber	Light/Short	Medium/medium (Intermediate)	Heavy/Long
Cannon Artillery	Caliber and Maximum Range ¹	120 mm or less	Greater than 120 mm but not greater than 160 mm	Greater than 160 mm but not greater than 210 mm
Mortar	Caliber	60 mm or less	Greater than 60 mm but less than 107 mm	107 mm or larger
Semitrailers	Cargo Capacity	Less than 12 tons	Between 12 tons and 40 tons	Greater than 40 tons
Utility Helicopters	Weight	Less than 4,000 lbs	Between 4,000 lbs and 10,000 lbs	Greater than 10,000 lbs
	Range	Less than 240 nautical miles	Between 240 and 320 nautical miles	Greater than 320 nautical miles
Watercraft (Army)	Capacity	Less than 300 tons	Between 300 tons and 1,700 tons	Greater than 1,700 tons
¹ Cannon artillery has a very heavy category: greater than 210 mm.				

Chapter 7

Graphic Control Measures

Graphic control measures are graphic directives given by a commander to subordinate commanders to assign responsibilities, coordinate fire and maneuver, and control combat operations. They include boundaries; lines; areas; points; targets; or nuclear, biological or chemical attacks/events. Land graphic control measures are classified as maneuver, fire support, command and control, mobility/countermobility/survivability, and combat service support. This chapter establishes a standard system for the development and use of graphic control measures. These graphic control measures are the standard for all simulations, including those used in live, virtual, and constructive environments.

Note. For most graphic control measures, there is a corresponding definition in chapter 1. In an electronic copy, click on the page number to view the definition, then click on the corresponding page number to return to the graphic control measure. Included with the definition is the field manual that provides further information on the use of that graphic control measure.

OVERLAYS

7-1. Overlays are graphics drawn on top of a map, sketch, or photograph. To ensure accurate alignment, the overlay must have at least two reference marks at opposite locations. (FM 101-5 provides the minimum labeling requirements for an overlay.) On automated displays, overlays are graphical information that is joined electronically so it can be “turned on or off” over or in front of the primary digital display, such as a map, sketch, or photograph.

COLORS

7-2. When drawing manually or using a color computer-generated display, show all friendly graphic control measures in black. Show hostile graphic control measures in red. If red is not available, place the abbreviation “ENY” on the graphic in at least two places. If other colors are used to show friendly or hostile factions, use a legend to ensure understanding of the use of colors on the overlay. If neutral or unknown graphic control measures are included on the overlay, use green and yellow if available. If green and yellow are not available, draw neutral or unknown graphics in black and include the abbreviations of “NEU” for neutral or “UNK” for unknown. Draw all obstacles—friendly, hostile, neutral, unknown or factional—using green; if green is not available, draw obstacles using black. (Obstacle graphics are shown in the mobility and survivability section.)

ORIENTATION OF CONTROL MEASURES

7-3. Most of the control measures in this chapter have a 360-degree orientation capability. Control measures are oriented to reflect their position on the ground. The labeling of those symbols is described in the next paragraph.

BUILDING GRAPHIC CONTROL MEASURES

LABELING

7-4. Make all text labeling upper case letters. The reader should be able to read the labels for all text labels of modifier fields for graphic control measures when the bottom of the overlay is closest to the reader. Labeling written on an angle should be readable when the overlay is turned a quarter of a turn (90 degrees) clockwise (to the right) or counterclockwise (to the left). For boundaries, abbreviations of unit designations can be used when the abbreviation will not cause confusion. (See table 7-1 for the description of fields for text or graphic modifiers for boundaries. See table 7-2, page 7-5, for a list of abbreviations for unit designations.)

BOUNDARIES

7-5. For boundaries, place size markings perpendicular to the boundary line. For all boundaries, use Arabic numerals to show the numbers of units, except for a corps boundary—use Roman numerals to show the number of corps. Figure 7-1 provides the orientation of boundary modifier fields for horizontal (east/west) and vertical (north/south) boundaries. Figures 7-2 (page 7-3) through 7-5 (page 7-4) are examples of boundary symbols as they are used.

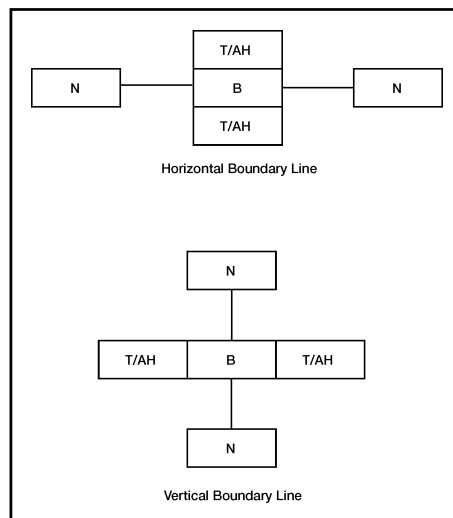

Figure 7-1. Boundary Modifier Fields

Table 7-1. Description of Fields for Text or Graphic Modifiers for Boundaries

<i>Field</i>	<i>Field Type</i>	<i>Description</i>	<i>Text/Graphic</i>
B	Echelon	A symbol modifier that denotes the size of a unit (see table 5-6, page 5-33). ¹	Both
N	Hostile (Enemy)	Denotes hostile symbol. The letters "ENY" are used when color red is not used (see paragraph 7-2) "colors."	Text
T	Unique Designation	An alphanumeric designator that uniquely identifies a particular unit (designation).	Text
AH	Country Indicator	A two-letter code that indicates the country of origin of the unit (see chapter 2).	Text

¹The symbol for the highest echelon unit on lateral boundary is used for the boundary line. The symbol for the lower echelon unit on a rear or forward boundary is used for the boundary line.

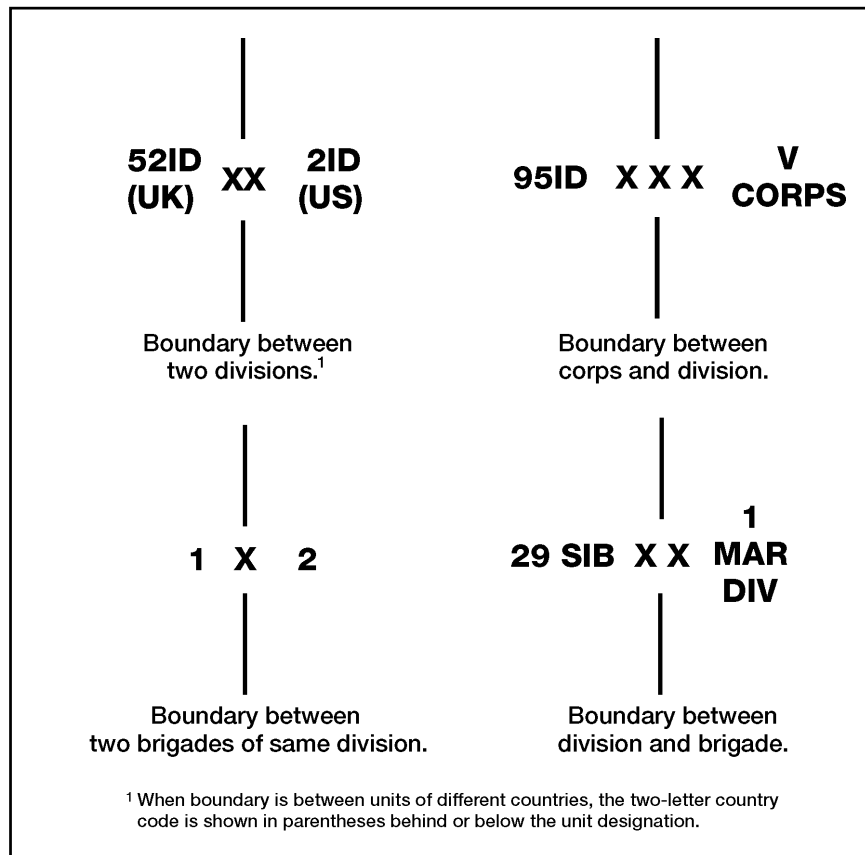

Figure 7-2. Examples of Friendly Lateral Boundaries

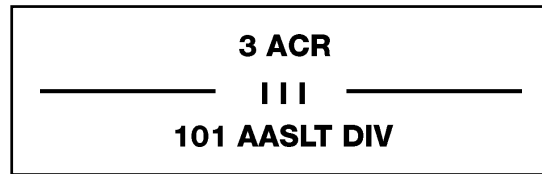

Figure 7-3. Example of a Friendly Rear Boundary

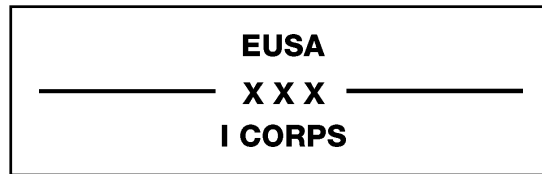

Figure 7-4. Example of a Friendly Forward Boundary

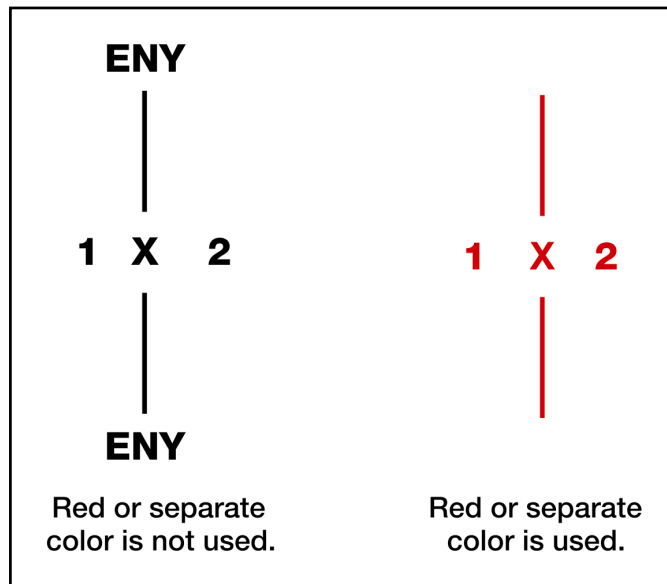

Figure 7-5. Examples of Hostile Lateral Boundaries

Table 7-2. Unit Abbreviations

<i>Unit Designation</i>	<i>Abbreviation</i>
Army	ARMY
• Third United States Army	• TUSA
• Eighth United States Army	• EUSA
Corps	CORPS
Marine Expeditionary Force	MEF
Division	DIV
• Airborne Division	• ABN DIV
• Air Assault Division	• AASLT DIV
• Armored Division	• AD
• Cavalry Division	• CD
• Infantry Division	• ID
□ Infantry Division (Light)	□ ID(L)
□ Infantry Division (Mechanized)	□ ID(M)
• Marine Division	• MAR DIV
• Motorized Division	• MTZ DIV
• Mountain Division	• MTN DIV
Brigade	BDE
• Marine Expeditionary Brigade	• MEB
• Separate Armored Brigade	• SAB
• Separate Infantry Brigade	• SIB
Regiment	REGT
Marine Expeditionary Unit	MEU
Battalion	BN
Squadron	SQDN
Company	CO
Troop	TRP
Battery	BTRY
Platoon	PLT
Squad	SQD

LINES

7-6. Most lines should also be named as a phase line for easy reference during orders and radio transmissions. Mark phase lines as “PL (name).” Label other lines that have a specific purpose and are also named as phase lines (such as no-fire line, “NFL”) on top of the line at both ends of the line inside the lateral boundaries, or as often as necessary for clarity. (See figure 7-6 for line modifier fields; figure 7-7 is an example of how line symbols are used. See table 7-3 for description of fields for text or graphic modifiers for lines.)

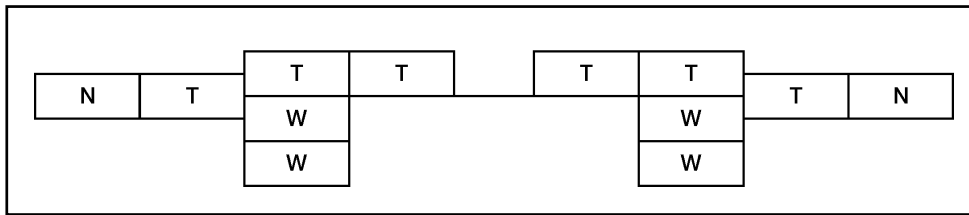

Figure 7-6. Line Modifier Fields

Table 7-3. Description of Fields for Text or Graphic Modifiers for Lines

<i>Field</i>	<i>Field Type</i>	<i>Description</i>	<i>Text/Graphic</i>
N	Hostile (Enemy)	Denotes hostile symbol. The letters "ENY" are used.	Text
T	Unique Designation	An alphanumeric title that uniquely identifies a particular control measure line (FSCL, NFL, PL, RFL) with a unit (designation) or name.	Text
W ¹	Date-Time Group	An alphanumeric designator for displaying a date/time group (DDHHMMSSZMONYY) or "O/O" for on order.	Text

¹For graphic control measures, two "W" fields can be used to indicate the effective time of that graphic control measure.

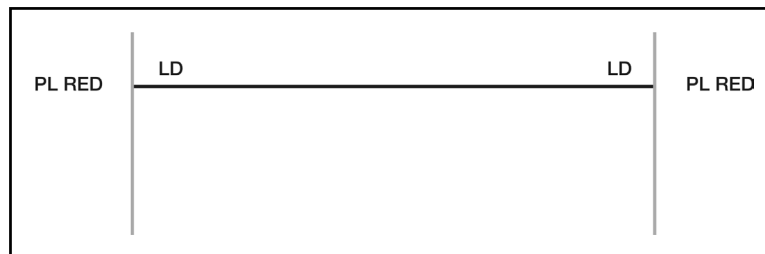

Figure 7-7. Example of a Friendly Line of Departure on a Phase Line

AREAS

7-7. Areas will normally be marked with the abbreviation for the type of area (see figure 7-8) followed by a name. Place this labeling in the center of the area unless the area is too small or the labeling would interfere with locating units (see figure 7-9). Not all fields are required for each area; some areas may use only one field, while others will use several. (See table 7-4 for description of fields for text or graphic modifiers for areas.)

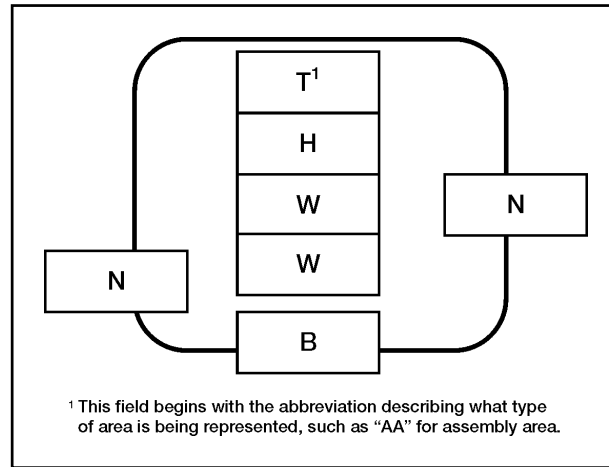

Figure 7-8. Area Modifier Fields

Table 7-4. Description of Fields for Text or Graphic Modifiers for Areas

<i>Field</i>	<i>Field Type</i>	<i>Description</i>	<i>Text/Graphic</i>
B	Echelon	A symbol modifier that denotes the size of a unit (see table 5-6, page 5-33).	Both
H	Additional Information	Free text.	Text
N	Hostile (Enemy)	Denotes hostile symbol. The letters "ENY" are used.	Text
T	Unique Designation	An alphanumeric title that uniquely identifies a particular symbol (AA, NFA, FFA, OBJ) with a particular unit (designation) or name.	Text
W ¹	Date-Time Group	An alphanumeric designator for displaying a date/time group (DDHHMMSSZMONYY) or "O/O" for on order.	Text

¹For graphic control measures, the two "W" fields can be used to indicate the effective time of that graphic control measure.

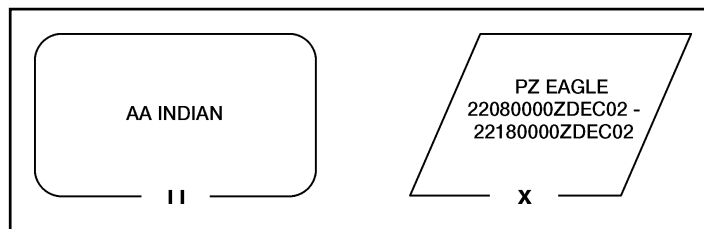

Figure 7-9. Examples of Friendly Assembly Area and Pickup Zone

POINTS

7-8. Most graphic control measure points are depicted as shown in figure 7-10. Supply points follow this format with a modification to the symbol. As with the symbol for supply units, there is an additional line placed toward the bottom of the box (see figure 7-11, page 7-9). However, there are other points (contact, coordination, decision, target) that are depicted differently. (See table 7-5, page 7-9, for description of fields for text or graphic modifiers for points.) The convention for depicting and labeling those points is shown in table 7-7, page 7-12, through table 7-17, page 7-62.

7-9. In building points, the name/type of the point is abbreviated and positioned inside the top part of the point symbol in field "A." For supply symbols, this may be a graphic depiction. In addition, below the abbreviation of the point name, the designation of the unit servicing that point can be included in field "T." To differentiate points, the point is numbered, lettered, or a combination. The number, letter, or combination is placed on the outside of the symbol on the right side at the top in field "T." On the outside of the point on the left side at the top and middle, date-time groups can be associated with the point. On the outside of the point at the top, additional information can be provided in field "H."

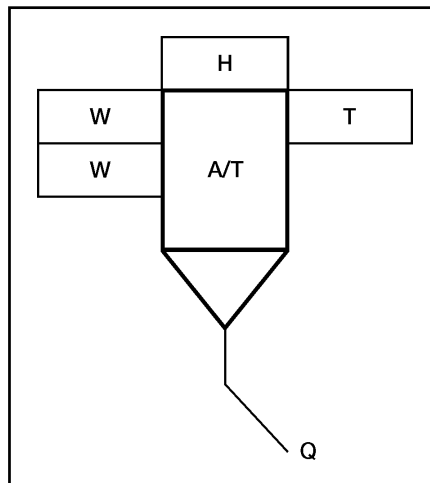

Figure 7-10. Point Modifier Fields

Table 7-5. Description of Fields for Text or Graphic Modifiers for Points

<i>Field</i>	<i>Field Type</i>	<i>Description</i>	<i>Text/Graphic</i>
A	Symbol	Icon or icons that represent the basic functions of the symbol. (The innermost part of a symbol.)	Both
H	Additional Information	Free text.	Text
T	Unique Designation	An alphanumeric title that uniquely identifies a particular symbol (such as AXP, DCN, EPW, MCP).	Text
W ¹	Date-Time Group	An alphanumeric designator for displaying a date/time group (DDHHMMSSZMONYY) or "O/O" for on order.	Text

¹For graphic control measures, the two "W" fields can be used to indicate the effective time of that graphic control measure.

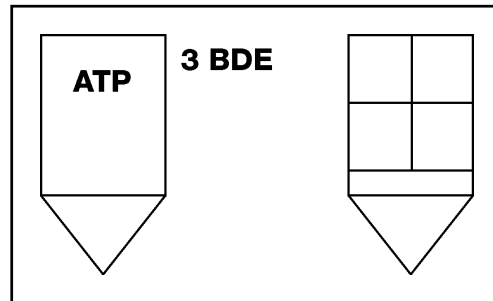

Figure 7-11. Examples of Friendly Ammunition Transfer Point and Class VIII Supply Point

FIRE SUPPORT COORDINATING MEASURES

7-10. Label fire support coordinating measures with the effective times, the controlling headquarters, and the abbreviation of the control measure. Place this labeling on both ends of the line (see examples in figure 7-12 and figure 7-13) and repeat as often as necessary for clarity along any line that passes through many boundaries.

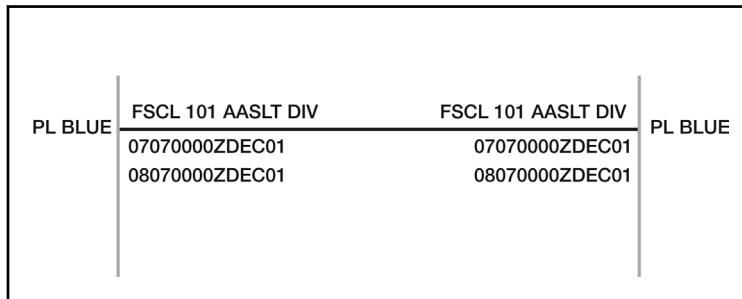

Figure 7-12. Example of a Friendly FSCL on a Phase Line

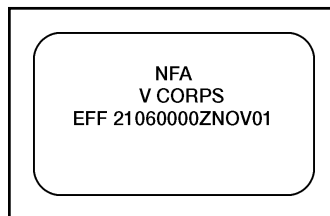

Figure 7-13. Example of a Friendly No-Fire Area

TARGETS

7-11. Targets are labeled with target designator, target altitude, and target description (as shown in figure 7-14). Guidance on determining the lettering and numbering for target designators is found in FM 6-20-40.

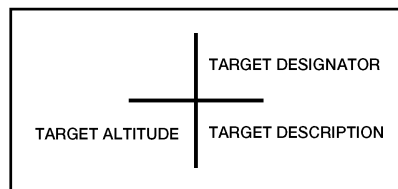

Figure 7-14. Target Labeling Fields

NUCLEAR, BIOLOGICAL, AND CHEMICAL ATTACKS/EVENTS

7-12. Nuclear, biological, and chemical attacks/events are depicted as shown in figure 7-15 through figure 7-17. (See table 7-6, page 7-11, for a description of fields for text or graphic modifiers for nuclear, biological, and chemical attacks/events. For examples and descriptions of field entries for fire support control measures, see figure 7-6, page 7-6, and table 7-3, page 7-6, for lines and figure 7-8, page 7-7, and table 7-4, page 7-7, for areas.)

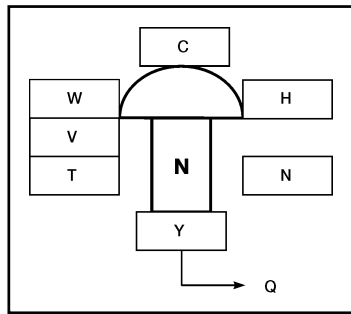

Figure 7-15. Nuclear Attack/Event

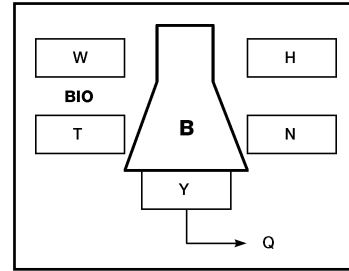

Figure 7-16. Biological Event

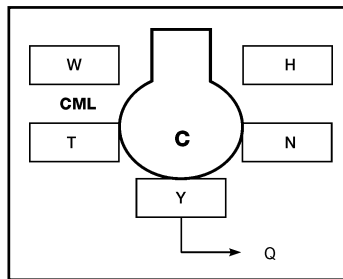

Figure 7-17. Chemical Event

Table 7-6. Description of Fields for Text or Graphic Modifiers for Nuclear, Biological, and Chemical Attacks/Events

<i>Field</i>	<i>Field Type</i>	<i>Description</i>	<i>Text/Graphic</i>
C	Quantity	A modifier that identifies the number of items present.	Text
H	Additional Information	Free text.	Text
N	Hostile (Enemy)	Denotes hostile symbol. The letters "ENY" are used.	Text
Q	Direction of Movement Arrow/Offset Location Indicator	With arrow, for nuclear, biological, or chemical release events indicates downwind direction. Without arrow, it is used to denote precise location or to declutter.	Graphic
T	Unique Designation	For friendly nuclear strikes, designates the friendly delivery system (missile, satellite, aircraft).	Text
V	Type of Equipment	Nuclear: Friendly weapon type.	Text
W	Date-Time Group	An alphanumeric designator for displaying a date/time group (DDHHMMSSZMONYY) or "O/O" for on order.	Text
Y	Location	Latitude and longitude or grid coordinates.	Text

Table 7-7. Examples of Maneuver Control Measures

Control Measure	Graphic	Example
Boundaries (See page 1-24 for definition.)		
Friendly Present Boundary		<p style="text-align: center;">2ID (US) XX 3ID (ROK)</p>
Friendly Planned or On Order Boundary		<p style="text-align: center;">10 MTN DIV XX 2 MAR DIV</p>
Enemy Known Boundary		<p style="text-align: center;">24 MTZ DIV ENY XX ENY 92 ID(L)</p>
Enemy Suspected Boundary		<p style="text-align: center;">16ID ENY XX ENY 34AD</p>
Lateral Boundaries. (See page 1-110 for definition.)		

Table 7-7. Examples of Maneuver Control Measures



Control Measure	Graphic	Example
Forward Boundaries	 <p>A schematic diagram showing a rectangular area with a central vertical line. On the left side, there are labels 'V CORPS XX 95 ID' and '95ID X 1'. On the right side, there are labels '95ID XX V CORPS' and '95ID XX V CORPS'. At the top, there are labels '9ID', 'XX', and '95ID'. At the bottom, there are labels '95ID', 'XX', and '5ID'. Inside the rectangle, there are labels '95ID X 3' and '3'. A small 'X' is located in the center of the rectangle.</p>	
Rear Boundaries (See page 1-157 for definition.)	 <p>A schematic diagram identical to the one above, showing a rectangular area with various labels and a central vertical line. The labels and symbols are the same as in the 'Forward Boundaries' example.</p>	
Lines		
Forward Line of Own Troops (FLOT). (See page 1-85 for definition.) Friendly Present	 <p>A series of four connected, rounded, hump-like shapes representing the forward line of own troops.</p>	 <p>Two horizontal lines representing boundaries. The top line has an 'X' on its left side and a circle with an 'X' on its right side, labeled 'FLOT'. The bottom line has an 'X' on its left side and a circle with an 'X' on its right side, labeled 'FLOT'. A vertical wavy line connects the two circles.</p>

Table 7-7. Examples of Maneuver Control Measures

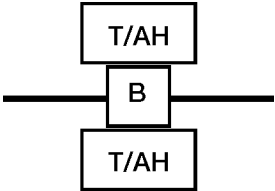
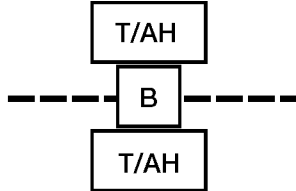
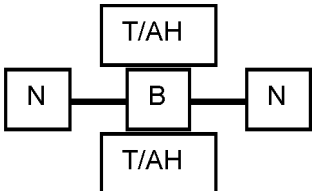
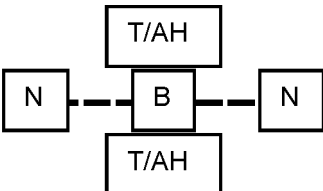
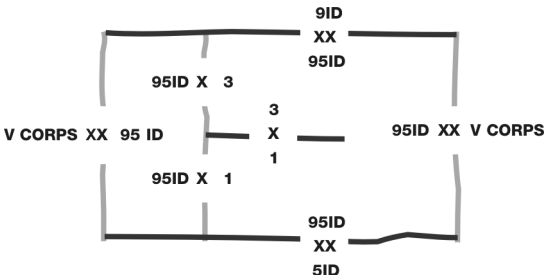



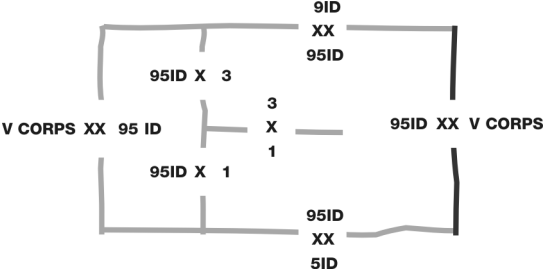
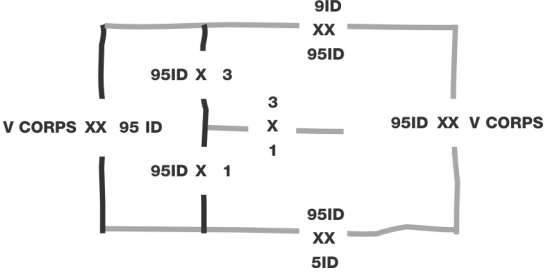

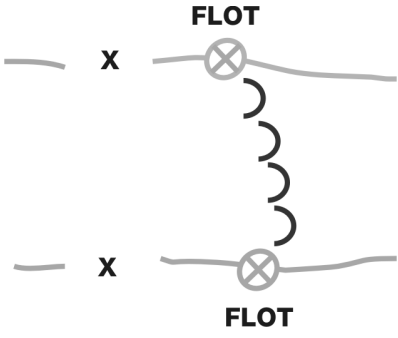
Control Measure	Graphic	Example
<p>Forward Line of Own Troops (FLOT) Friendly Planned or On Order</p>		
<p>Forward Line of Own Troops (FLOT) Enemy Known or Confirmed</p>		
<p>Forward Line of Own Troops (FLOT) Enemy Suspected</p>		
<p>Line of Contact (LC). (See page 1-113 for definition.)</p>		

Table 7-7. Examples of Maneuver Control Measures

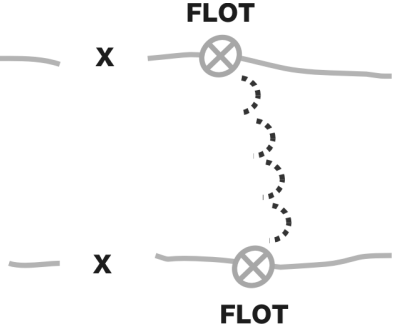

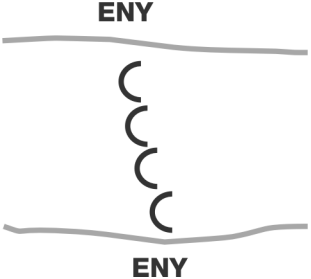

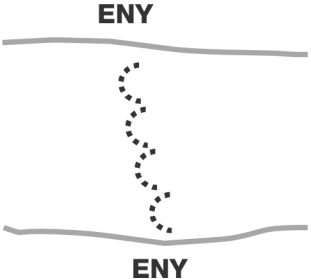

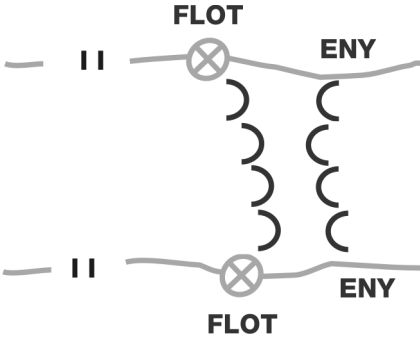
Control Measure	Graphic	Example
Phase Line (PL). (See page 1-145 for definition.)	<p>PL (NAME) — PL (NAME)</p>	<p>PL RED  PL RED</p>
Handover Line. (See page 1-91 for definition.)	<p>HL — HL</p>	<p>PL SAND  PL SAND</p>
Areas		
Friendly Area		
Friendly Planned or On Order Area		
Enemy Known or Confirmed Area		

Table 7-7. Examples of Maneuver Control Measures

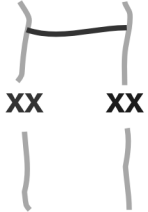
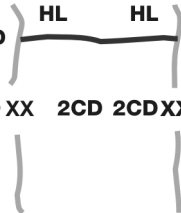



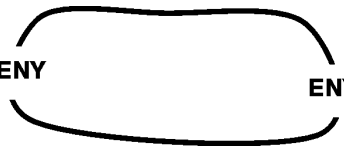

Control Measure	Graphic	Example
Enemy Suspected Area		
Assembly Area (AA). (See page 1-15 for definition.)		
Occupied Assembly Area (AA)		
Assembly Area (AA) Occupied by Multiple Units		
Proposed or On Order Assembly Area (AA)		
Forward Assembly Area (FAA)		

Table 7-7. Examples of Maneuver Control Measures

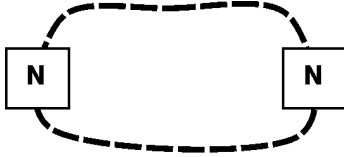
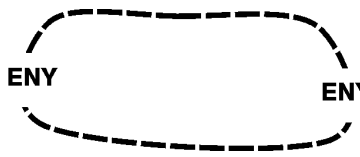

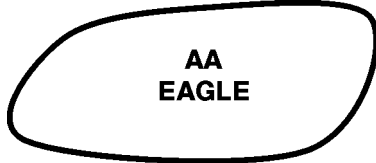
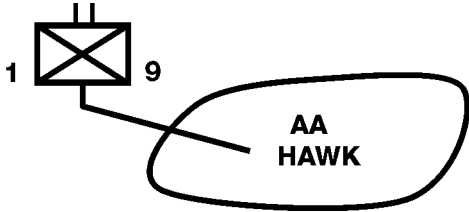
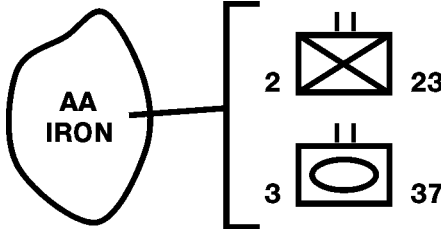

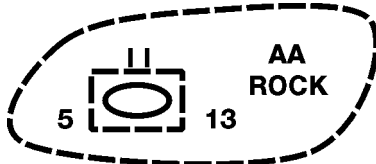
Control Measure	Graphic	Example
Specified Areas		
Drop Zone (DZ). (See page 1-67 for definition.)		
Extraction Zone (EZ). (See page 1-76 for definition.)		
Landing Zone (LZ). (See page 1-109 for definition.)		
Pickup Zone (PZ). (See page 1-146 for definition.)		
Search Area/ Reconnaissance Area		

Table 7-7. Examples of Maneuver Control Measures



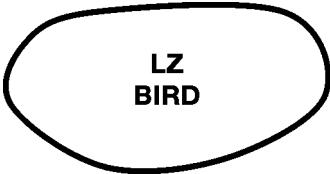
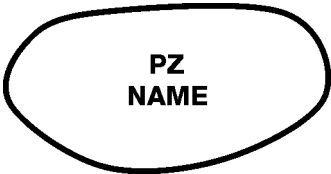
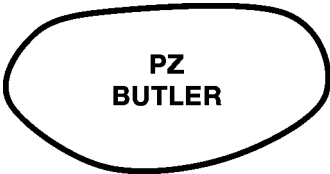
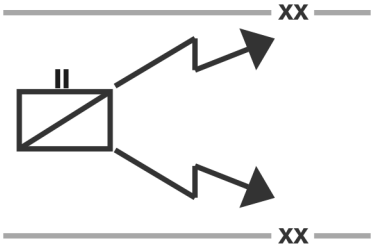

<i>Control Measure</i>	<i>Graphic</i>	<i>Example</i>
Engagement Area (EA). (See page 1-71 for definition.)		
Fortified Area		
Points		
Point of Interest		

Table 7-8. Examples of Airspace Control Measures

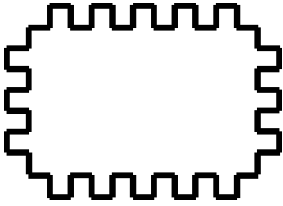
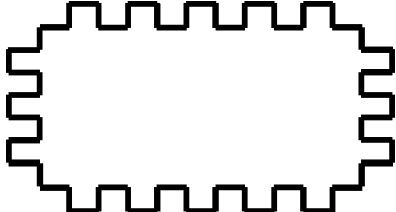

Control Measure	Graphic	Example
<p>Note: (See page 1-8 for definition of Airspace Control Measures (ACM))</p>		
<p>Lines</p>		
<p>Air Corridor. (See page 1-6 for definition.)</p>	<p>NAME HEADING INTO HOSTILE AIRSPACE</p> <hr/> <p>HEADING OUT FROM HOSTILE AIRSPACE</p>	
<p>Air Corridor</p>		
<p>Minimum-Risk Route (MRR). (See page 1-125 for definition.)</p>	<p>MRR</p> <hr/> <p>W W</p>	
<p>Standard-Use Army Aircraft Flight Route (SAAFR). (See page 1-176 for definition.)</p>	<p>NAME _____</p> <p>WIDTH _____</p> <p>MIN ALT _____</p> <p>MAX ALT _____</p> <hr/> <p>NAME</p> <hr/>	<p>NAME GOLD</p> <p>WIDTH 3K</p> <p>MIN ALT 1000M</p> <p>MAX ALT 3000M</p>
<p>Standard-Use Army Aircraft Flight Route (SAAFR)</p>	<p>NAME WHITE</p> <p>WIDTH 2K</p> <p>MIN ALT 700M</p> <p>MAX ALT 2700M</p>	

Table 7-8. Examples of Airspace Control Measures

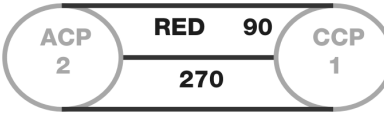
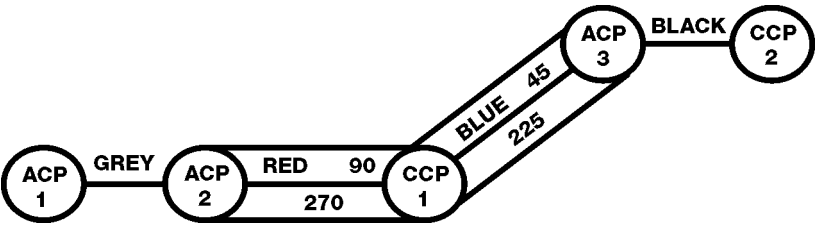
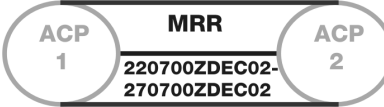
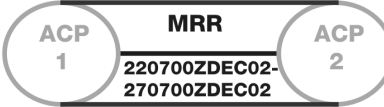

Control Measure	Graphic	Example
Unmanned Aerial Vehicle (UAV) Route		
Low-Level Transit Route (LLTR). (See page 1-115 for definition.)		
Areas		
Restricted Operations Zone (ROZ). (See page 1-162 for definition.)		
Forward Area Air Defense Engagement Zone (FAADEZ). (See page 1-84 for definition.)		
High-Density Airspace Control Zone (HIDACZ). (See page 1-93 for definition.)		

Table 7-8. Examples of Airspace Control Measures

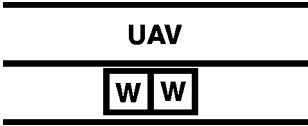
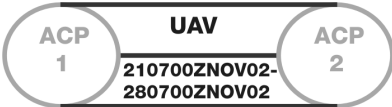
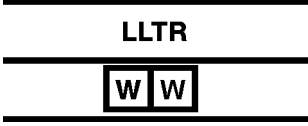

Control Measure	Graphic	Example
Missile Engagement Zone (MEZ)		
Low-Altitude Missile Engagement Zone (LOMEZ). (See page 1-115 for definition.)		
High-Altitude Missile Engagement Zone (HIMEZ). (See page 1-93 for definition.)		
Weapons Free Zone (WFZ). (See page 1-199 for definition.)		

Table 7-8. Examples of Airspace Control Measures

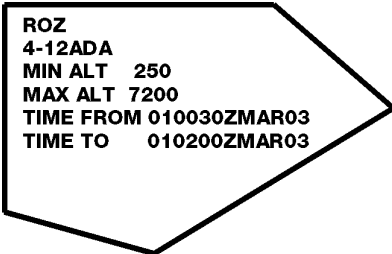
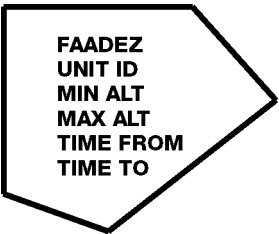
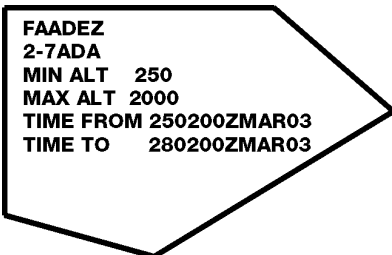
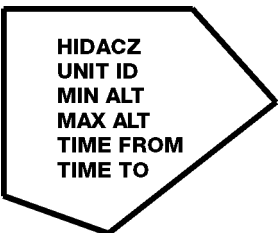
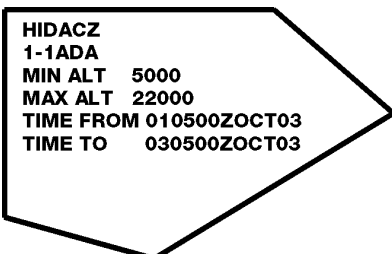



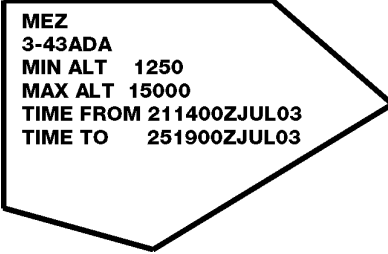
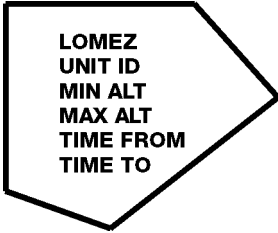
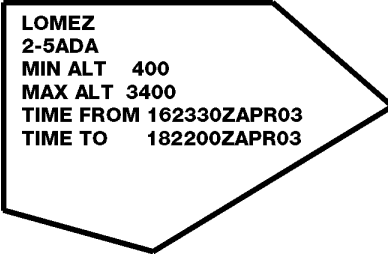
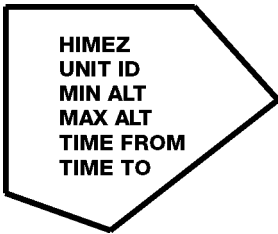
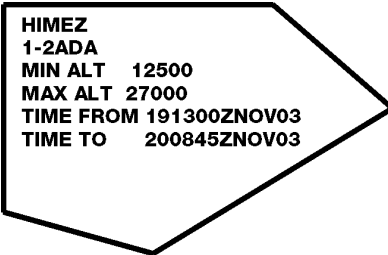
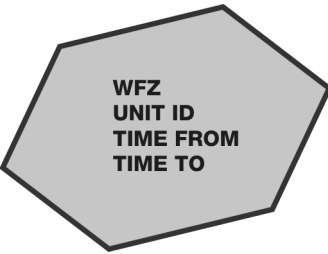

<i>Control Measure</i>	<i>Graphic</i>	<i>Example</i>
Points		
Air Control Point (ACP). (See page 1-5 for definition.)		
Communications Checkpoint (CCP). (See page 1-40 for definition.)		
Pop-Up Point (PUP). (See page 1-148 for definition.)		
Downed Aircrew Pickup Point. (See page 1-66 for definition.)		

Table 7-9. Examples of Deception Control Measures

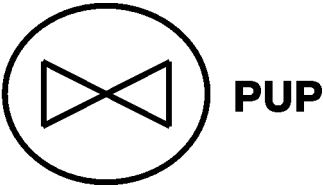
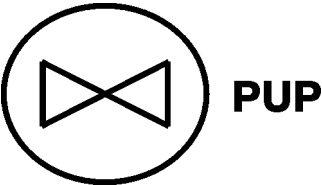

Control Measure	Graphic	Example
Note: (See page 1-52 for definition of deception.)		
Decoys/Feints		
Dummy (also Decoy or Feint). (See pages 1-54 and 1-76 for definitions.)		
Axis of Advance for a Feint		
Direction of Attack for a Feint		
Decoy Mined Area		
Fenced Decoy Mined Area		

Table 7-9. Examples of Deception Control Measures



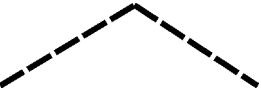
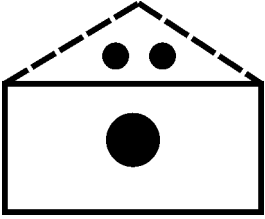

Control Measure	Graphic	Example
Phony Minefield. (See page 1-146 for definition.)		
Lines		
Forward Edge of the Battle Area (FEBA). (See page 1-85 for definition.)		<div style="text-align: center;">  <p>Actual Trace</p> <hr/>  <p>Proposed or On Order</p> </div>
Final Protective Line (FPL). (See page 1-78 for definition.)		

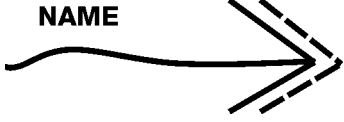
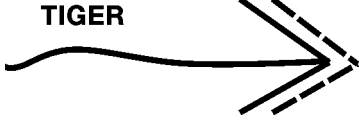
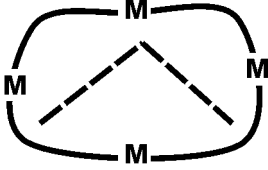
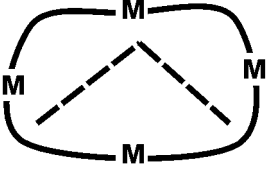
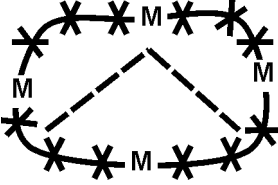
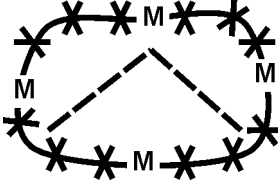
Table 7-9. Examples of Deception Control Measures



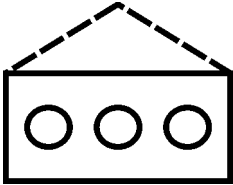
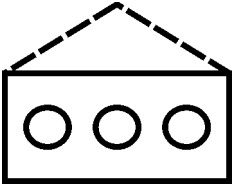
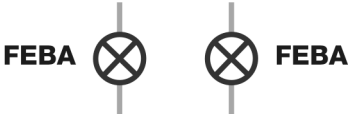

Control Measure	Graphic	Example
Areas		
Battle Position (BP) (See page 1-21 for definition.)		
Occupied		
Note: The side opposite Field B (Echelon) faces toward the hostile force.		
Prepared but not Occupied		
Planned		
Engagement Area (EA). (See page 1-71 for definition.)		
Friendly Strong Point (SP). (See page 1-178 for definition.)		

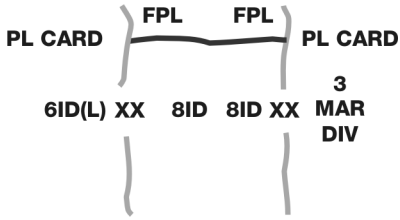
Table 7-9. Examples of Deception Control Measures

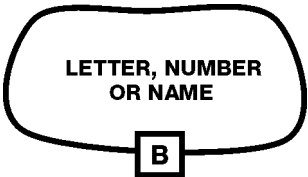

Control Measure	Graphic	Example
Enemy Known or Confirmed Strong Point		
Observation Post (OP)/Outpost. (See page 1-135 for definition.)		<p>1/1/A/1-1IN</p> 
Combat Outpost. (See page 1-35 for definition.)		<p>B/1-15IN</p> 
Observation Outpost Occupied by Reconnaissance		<p>C/2/1-1CAV</p> 
Forward Observer (FO) Position		<p>3-319FA</p> 

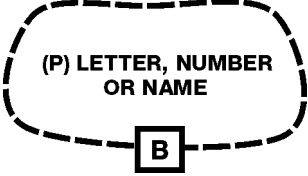
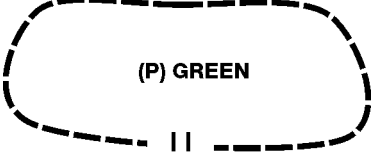
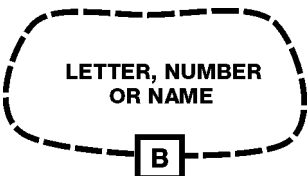
Table 7-9. Examples of Deception Control Measures

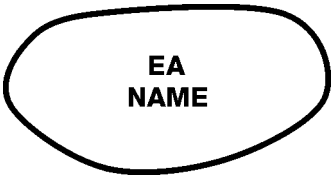
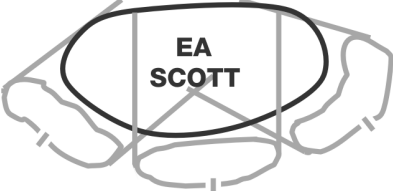
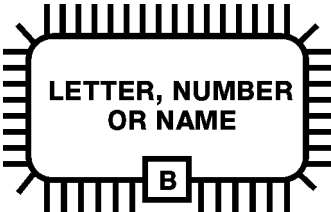
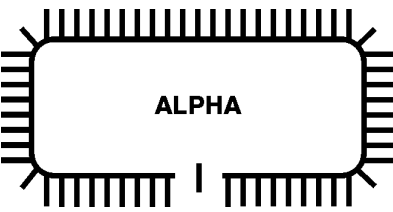

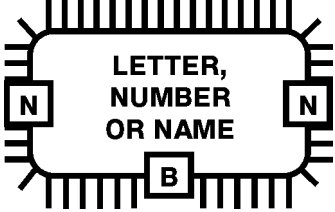
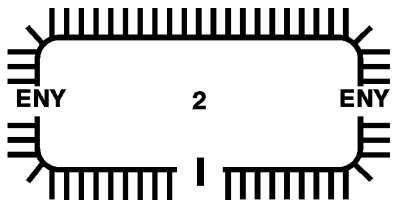
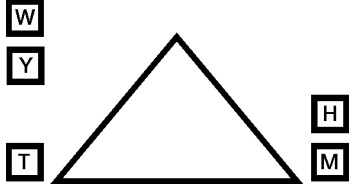
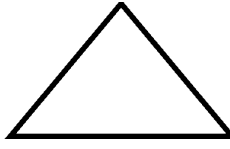
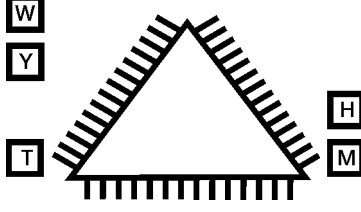
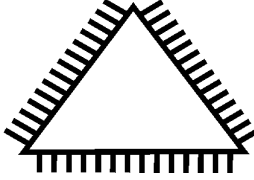
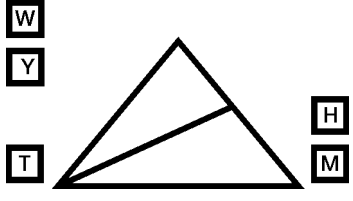
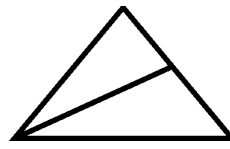
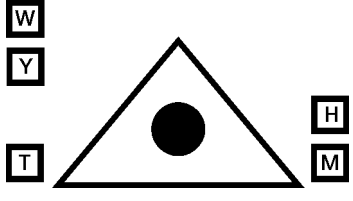

Control Measure	Graphic	Example
Sensor Outpost/Listening Post		<p>2/B/311MI</p> 
NBC Observation Post (Dismounted)		<p>63CHEM</p> 
Principal Direction of Fire (PDF)		
<p>Note: The example shows the sector of fire of an automatic rifle. The PDF is along the left side of the sector. Field A shows the equipment symbol for an automatic rifle.</p>		
<p>Points</p>		
<p>Target Reference Point (TRP). (See page 1-185 for definition.)</p>		

Table 7-10. Examples of Offensive Control Measures



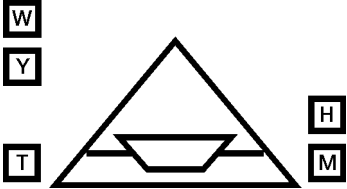

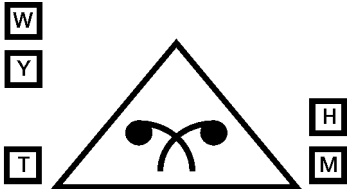
Control Measure	Graphic	Example
<p>Axis of Advance (See page 1-17 for definition.) Note: A unit symbol will precede friendly axis of advance control measures.</p>		
<p>Friendly Aviation Axis of Advance</p>		<p>1-101 </p>
<p>Friendly Airborne Axis of Advance</p>		<p>3  82</p>
<p>Friendly Attack Helicopter Axis of Advance</p>		<p>1-17 </p>
<p>Friendly Ground Axis of Shaping Operations Friendly Ground Axis of Supporting Attack</p>		<p>1  45</p>
<p>Friendly Ground Axis of Decisive Operations Friendly Ground Axis of Main Attack</p>		<p>2  7</p>
<p>Friendly Ground Axis On Order with Date and Time (if known) Effective</p>		

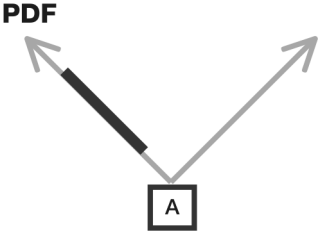
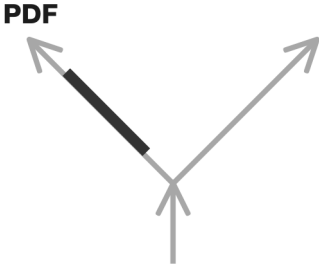
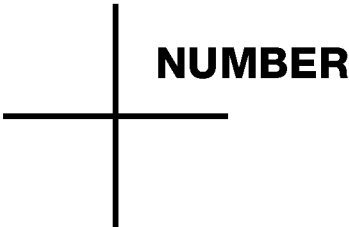
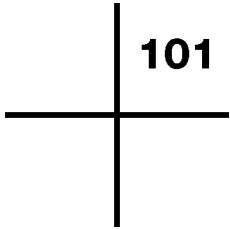
Table 7-10. Examples of Offensive Control Measures



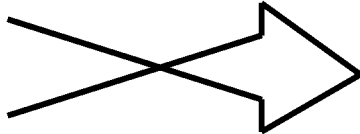
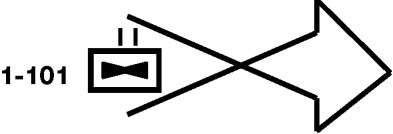
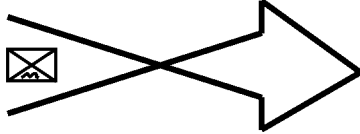
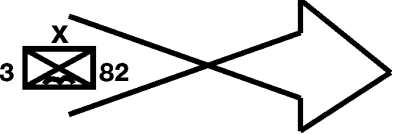
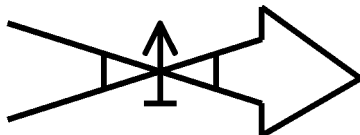
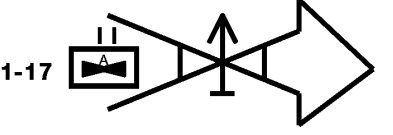
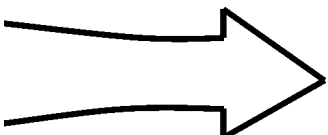
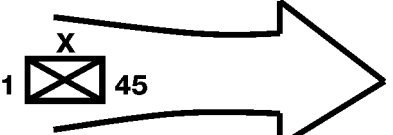

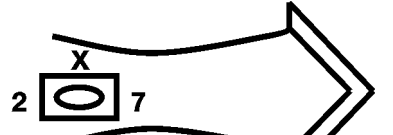

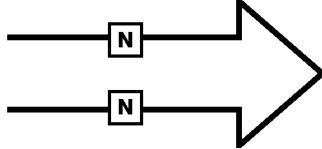
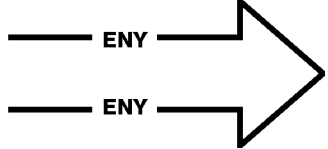
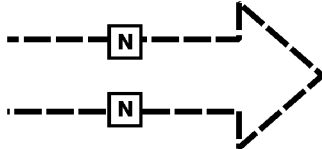
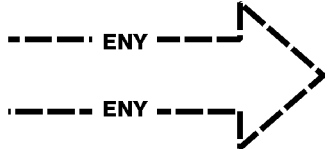

Control Measure	Graphic	Example
Enemy Known or Confirmed Axis of Advance		
Enemy Templated or Suspected Axis of Advance		
<p>Direction of Attack (See page 1-61 for definition.) Note: A unit symbol will precede friendly direction of attack control measures.</p>		
Friendly Aviation Direction of Attack		
Friendly Aviation Planned or On Order Direction of Attack		
Enemy Aviation Known or Confirmed Direction of Attack		
Enemy Aviation Templated or Suspected Direction of Attack		
<p>Friendly Direction of Shaping Operations</p> <p>Friendly Direction of Supporting Attack</p>		

Table 7-10. Examples of Offensive Control Measures



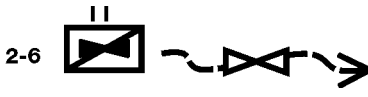



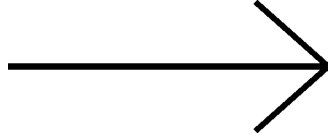
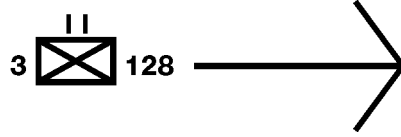

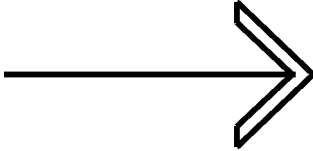
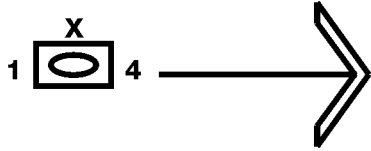

Control Measure	Graphic	Example
Friendly Direction of Decisive Operations Friendly Direction of Main Attack		
Friendly Direction of Attack Planned or On Order		
Enemy Ground Known or Confirmed Direction of Attack		
Enemy Ground Templated or Suspected Direction of Attack		
Lines		
Final Coordination Line (FCL). (See page 1-78 for definition.)		
Infiltration Lane. (See page 1-98 for definition.)		

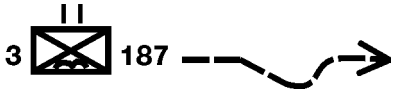
Table 7-10. Examples of Offensive Control Measures





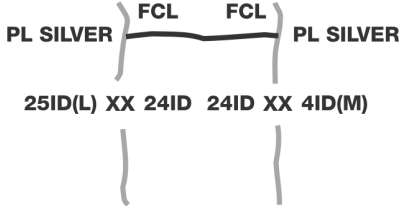

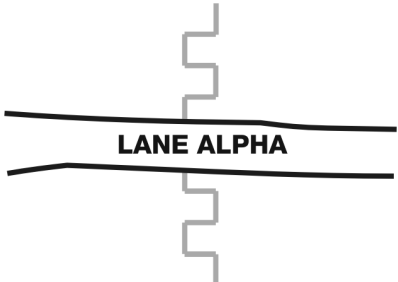

Control Measure	Graphic	Example
Limit of Advance (LOA). (See page 1-112 for definition.)		
Line of Departure (LD). (See page 1-113 for definition.)		
Line of Departure/ Line of Contact (LD/LC). (See page 1-113 for definition.)		
Probable Line of Deployment (PLD). (See page 1-151 for definition.)		
Areas		
Assault Position. (See page 1-15 for definition.)		

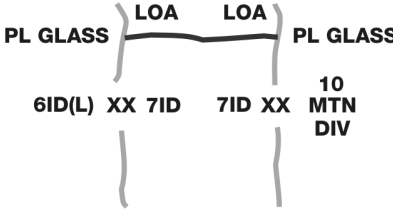
Table 7-10. Examples of Offensive Control Measures

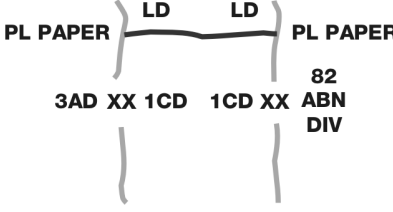

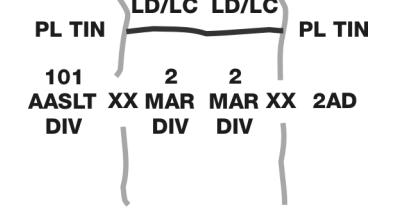

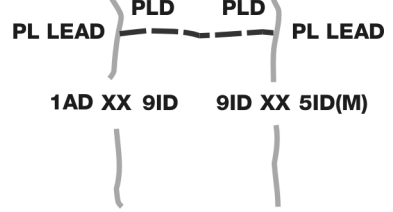

<i>Control Measure</i>	<i>Graphic</i>	<i>Example</i>
Attack Position (See page 1-16 for definition.)		
Friendly Attack Position		
Friendly Occupied Attack Position (only if a unit must stop in the attack position)		
Friendly Attack Position Planned, Proposed, or On Order		
Attack by Fire Position. (See page 1-16 for definition.)		
Support by Fire Position. (See page 1-179 for definition.)		
Objective. (See page 1-135 for definition.)		

Table 7-11. Examples of Special Maneuver Control Measures

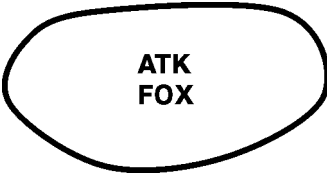
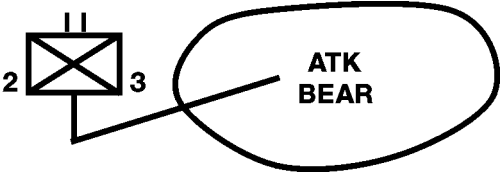
Control Measure	Graphic	Example
General		
Encirclement (See page 1-70 for definition.)		
Friendly Forces Encircled		
Hostile Forces Encircled		
Ambush. (See page 1-10 for definition.)		

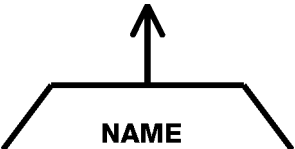
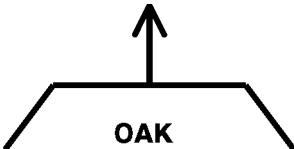
Table 7-11. Examples of Special Maneuver Control Measures

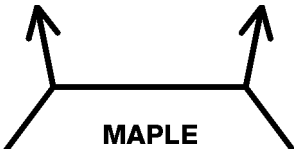

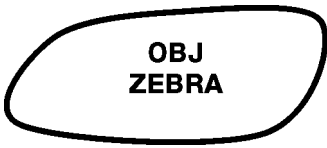

Control Measure	Graphic	Example
Lines		
<p>Airhead/Airhead Line (AL). (See page 1-6 for definition.)</p>	 <p style="text-align: center;">AL PL NAME</p>	 <p style="text-align: center;">AL PL OVERLORD</p>
<p>Bridgehead Line (BL). (See page 1-25 for definition.)</p>	 <p style="text-align: center;">BL BL</p>	 <p style="text-align: center;">BL BL PL METZ PL METZ</p> <p style="text-align: center;">RIVER</p>
<p>Holding Line (HL). (See page 1-94 for definition.)</p>	 <p style="text-align: center;">HL HL</p>	 <p style="text-align: center;">PL HUSKY HL</p> <p style="text-align: center;">— XX —</p> <p style="text-align: center;">— XX —</p> <p style="text-align: center;">HL PL HUSKY</p>
<p>Release Line (RL). (See page 1-160 for definition.)</p>	 <p style="text-align: center;">RL RL</p>	 <p style="text-align: center;">PL SAND RL RL PL SAND</p> <p style="text-align: center;">RIVER</p> <p style="text-align: center;">— XX —</p> <p style="text-align: center;">— XX —</p> <p style="text-align: center;">1 MAR XX 4AD 4AD XX 3ACR DIV</p>

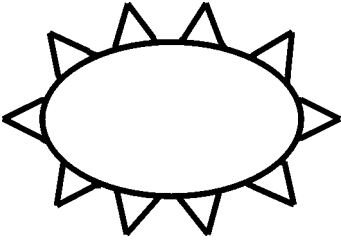
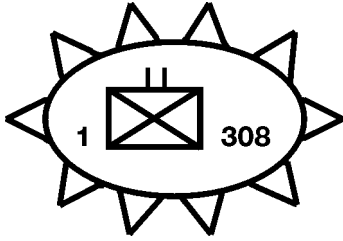
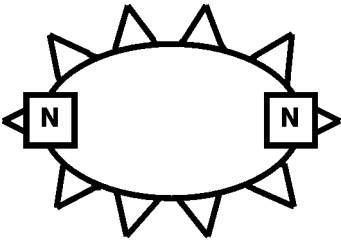
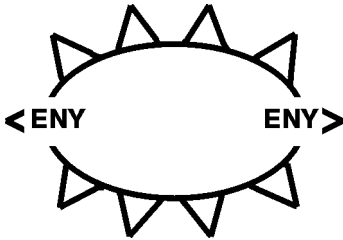
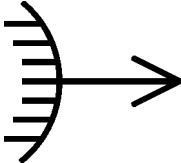
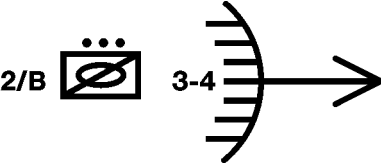
Table 7-11. Examples of Special Maneuver Control Measures

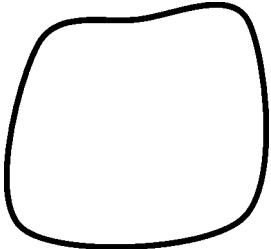
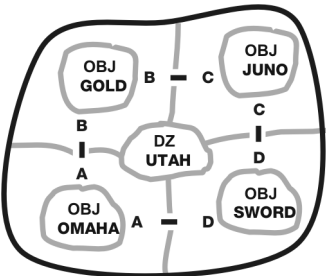
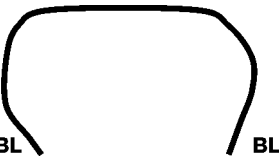
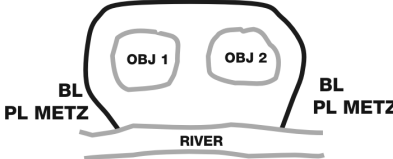

<i>Control Measure</i>	<i>Graphic</i>	<i>Example</i>
Areas		
<p>Area of Operations (AO). (See page 1-12 for definition.)</p>		
<p>Named Area of Interest (NAI). (See page 1-130 for definition.)</p>		
<p>Targeted Area of Interest (TAI). (See page 1-184 for definition.)</p>		

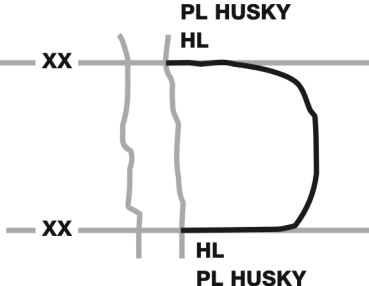
Table 7-12. Examples of Fire Support Coordinating Measures

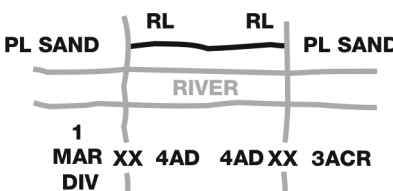

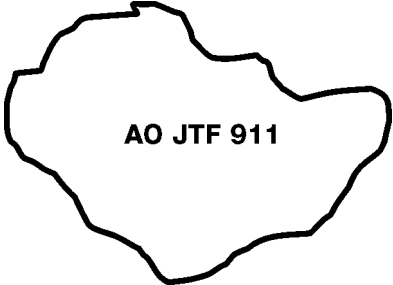

Control Measure	Graphic	Example
Points		
Fire Support Station (FSS). (See page 1-81 for definition.)		
Lines		
Coordinated Fire Line (CFL). (See page 1-45 for definition.)		
Fire Support Coordination Line (FSCL). (See page 1-80 for definition.)		
Restrictive Fire Line (RFL). (See page 1-163 for definition.)		

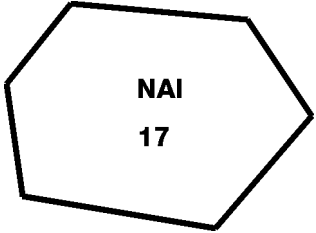
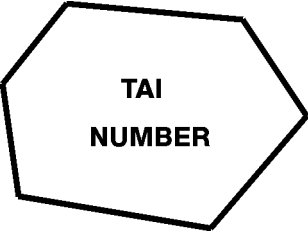
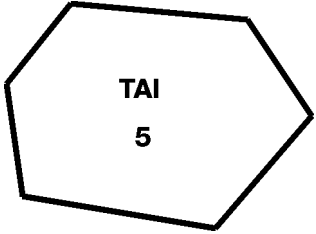
Table 7-12. Examples of Fire Support Coordinating Measures





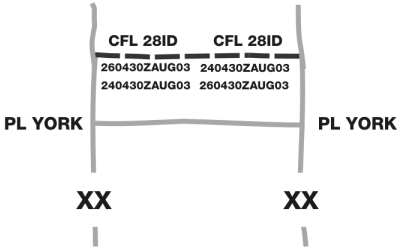
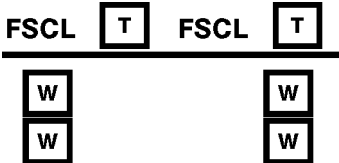
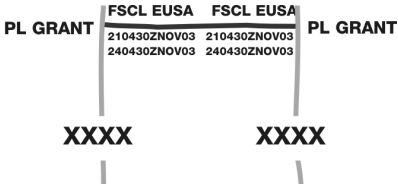

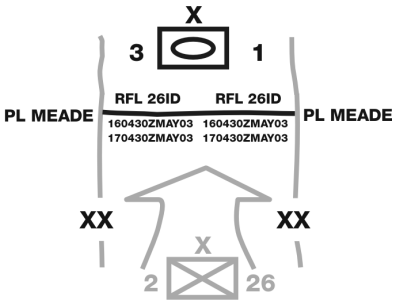

Control Measure	Graphic	Example
Areas		
Airspace Coordination Area (ACA). (See page 1-8 for definition.)		
Bomb Area		
Free Fire Area (FFA). (See page 1-86 for definition.)		
Fire Support Area (FSA). (See page 1-79 for definition.)		
No-Fire Area (NFA). (See page 1-132 for definition.)		

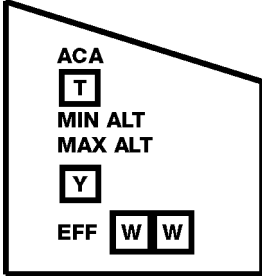
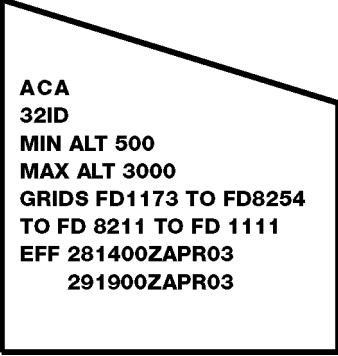
Table 7-12. Examples of Fire Support Coordinating Measures

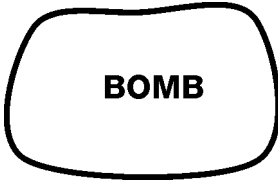
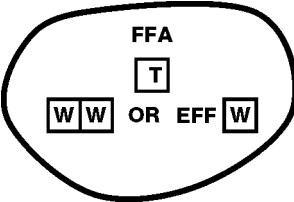

Control Measure	Graphic	Example
Position Area for Artillery (PAA). (See page 1-148 for definition.)		
Restrictive Fire Area (RFA). (See page 1-163 for definition.)		
Targets (See page 1-184 for definition.)		
Points (Target designators consist of two letters followed by four numerals.)		
Point/Single Target		
Nuclear Target. The point at the center of the target represents the desired ground zero.		
Linear Targets		
Linear Target		

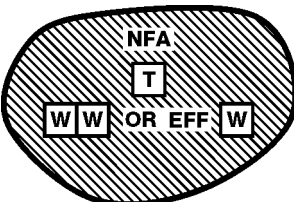
Table 7-12. Examples of Fire Support Coordinating Measures





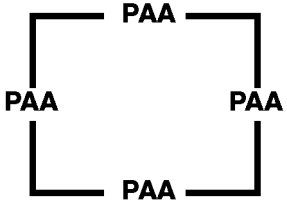
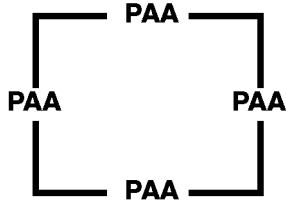
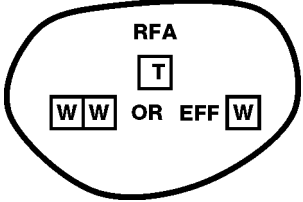
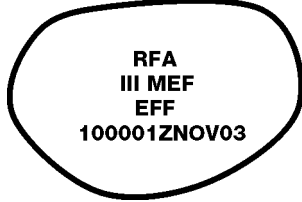
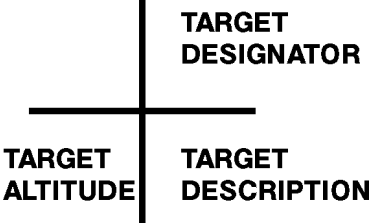
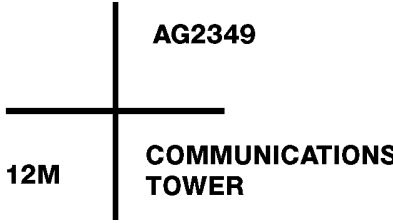
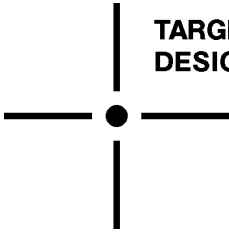
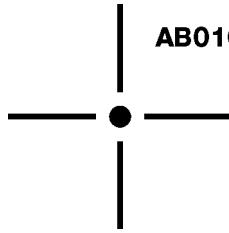

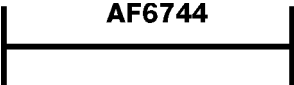

Control Measure	Graphic	Example
Final Protective Fire (FPF). (See page 1-78 for definition.)		
Area Targets (Target designators consist of two letters followed by four numerals.)		
Circular Target		
Rectangular		
Irregular Shaped Target		
Series of Targets (See page 1-169 for definition.)		
Series of Targets Using Regular Targets		

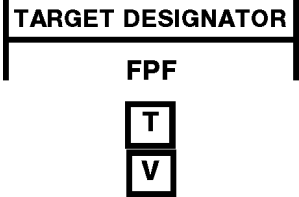
Table 7-12. Examples of Fire Support Coordinating Measures



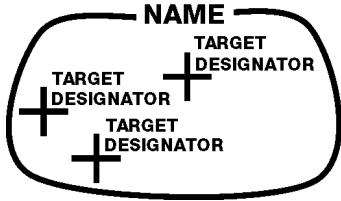
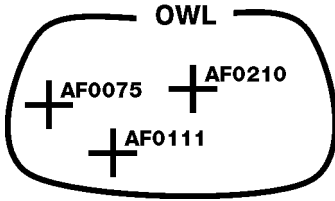

Control Measure	Graphic	Example
Series of Targets Using Rectangular Targets		
Group of Targets (See page 1-90 for definition.) (Target designators consist of two letters followed by four numerals.)		
Group of Targets Using Regular Targets		
Group of Targets Using Rectangular Targets		
Smoke Targets		
Linear Smoke Target		
Planned Smoke with Designated Time Shown		

Table 7-12. Examples of Fire Support Coordinating Measures

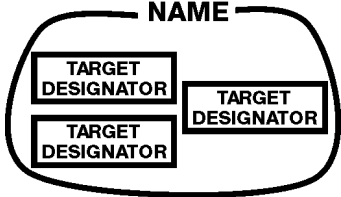
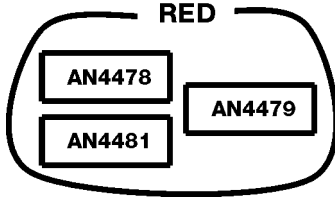
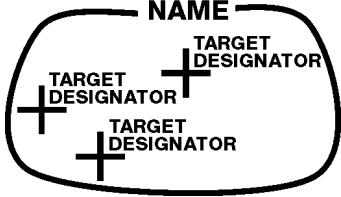
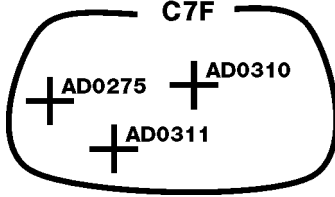
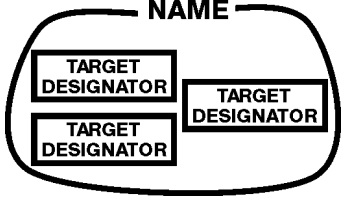
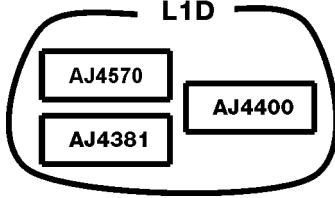

<i>Control Measure</i>	<i>Graphic</i>	<i>Example</i>
Smoke (actually in place)		

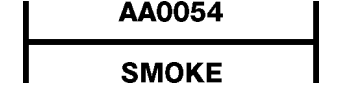
Table 7-13. Examples of Command and Control Measures

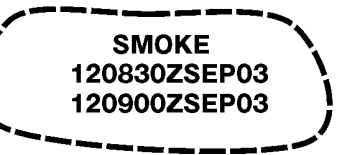
<i>Control Measure</i>	<i>Graphic</i>	<i>Example</i>
Points		
Special Point		
Contact Point (CP). (See page 1-43 for definition.)		
Coordination Point		

Table 7-13. Examples of Command and Control Measures



Control Measure	Graphic	Example
Decision Point (DP). (See page 1-53 for definition.)		
General or Unspecified Point		
Checkpoint (CKP). (See page 1-29 for definition.)		
Linkup Point (LU). (See page 1-113 for definition.)		

Table 7-13. Examples of Command and Control Measures

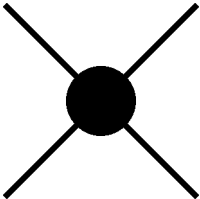
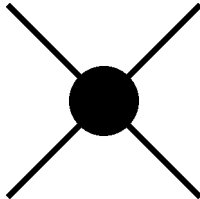
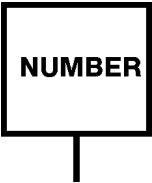
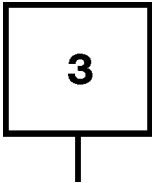
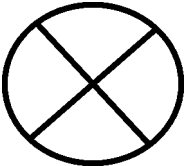
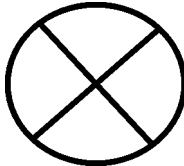
Control Measure	Graphic	Example
<p>Passage Point (PP). (See page 1-143 for definition.)</p>		
<p>Rally Point (RLY). (See page 1-155 for definition.)</p>		
<p>Release Point (RP). (See page 1-160 for definition.)</p>		
<p>Start Point (SP). (See page 1-176 for definition.)</p>		

Table 7-13. Examples of Command and Control Measures

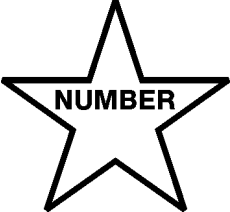

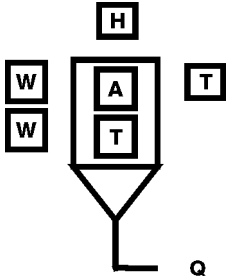
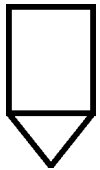
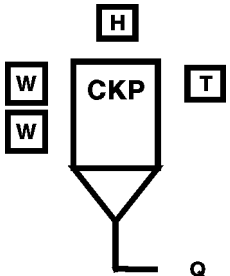
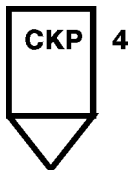
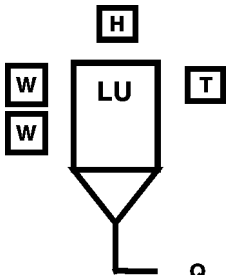
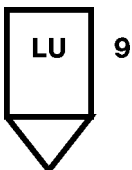
Control Measure	Graphic	Example
Way Point. (See page 1-198 for definition.)		
Lines		
Light Line (LL). (See page 1-112 for definition.)		
Areas		
Airfield Zone Note: Under Field "H," include type of airfield, length of runway, and other pertinent information.		

Table 7-14. Examples of Mobility/Counter-mobility/Survivability Control Measures

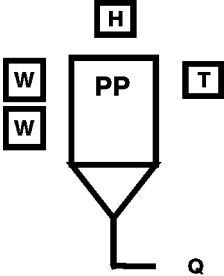
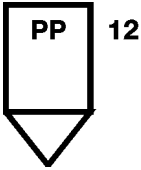
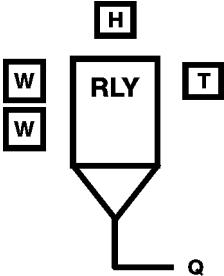
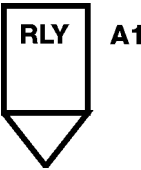
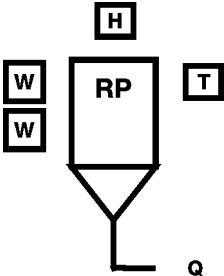
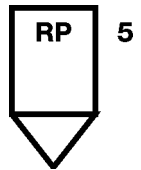
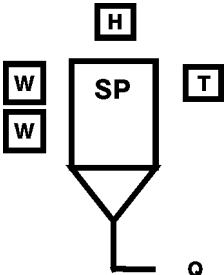
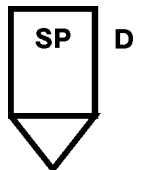



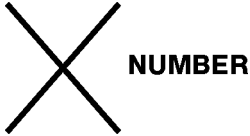

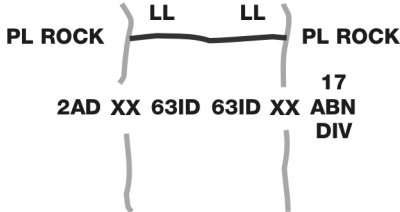
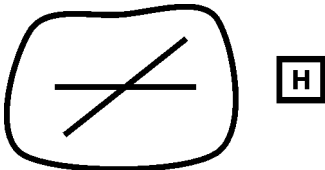
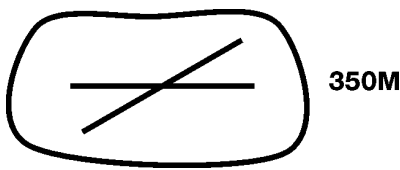
Control Measure	Graphic	Example
Obstacles (See page 1-136 for definition.)		
Abatis. (See page 1-1 for definition.)		
Belt Obstacle. (See page 1-136 for definition.)		
Obstacle Line. (See page 1-136 for definition.)		
Obstacle Zone. (See page 1-136 for definition.)		
Antitank Obstacles		
Note: The points of the antitank ditch face toward hostile force.		
Completed Antitank Ditch		
Antitank Ditch under Construction		

Table 7-14. Examples of Mobility/Counter-mobility/Survivability Control Measures

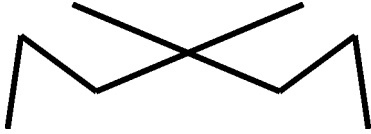
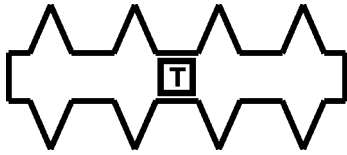

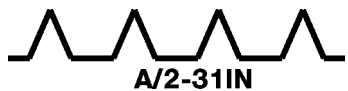
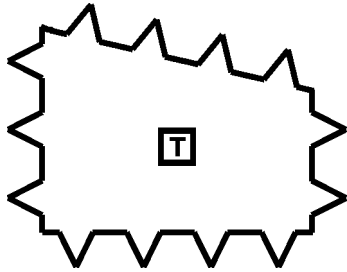
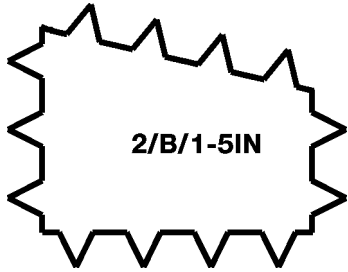

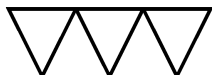





Control Measure	Graphic	Example
Antitank Ditch Reinforced with Antitank Mines		
Fixed and Prefabricated Antitank Obstacles, Tetrahedrons, Dragon's Teeth, and Other Similar Obstacles	<p>Fixed and Prefabricated</p> 	
Moveable Antitank Obstacles, Tetrahedrons, Dragon's Teeth, and Other Similar Obstacles	<p>Moveable</p> 	
Moveable and Prefabricated Antitank Obstacles, Tetrahedrons, Dragon's Teeth, and Other Similar Obstacles	<p>Moveable and Prefabricated</p> 	
Antitank Wall		
<p>Note: The points of the antitank wall face toward hostile force.</p>		
Booby Trap. (See page 1-23 for definition.)		
<p>Mines (See page 1-124 for definition.)</p>		
Antipersonnel (AP) Mines		

Table 7-14. Examples of Mobility/Counter-mobility/Survivability Control Measures





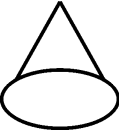
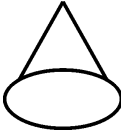





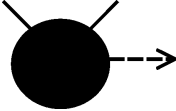

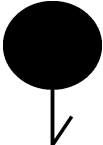
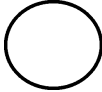
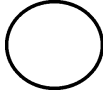
Control Measure	Graphic	Example
Antipersonnel Mine with Dashed Arrow Showing Direction of Effects		
Antitank (AT) Mine		
Antitank Mine with Anti-Handling Device		
Unspecified Mine		
Mine Cluster		
Wide Area Mine		
Minefields (See page 1-124 for definition.)		
Completed Minefield		
Planned Minefield		
Antipersonnel Minefield		
Antitank Minefield		

Table 7-14. Examples of Mobility/Counter-mobility/Survivability Control Measures

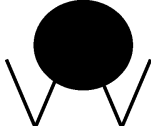
Control Measure	Graphic	Example
Antitank Minefield with Gap		 <p data-bbox="1122 667 1333 726">180300ZAPR03 180900ZAPR03</p>
Scatterable Mines Minefield with Self-Destruct Date-Time Group		 <p data-bbox="1049 963 1256 993">111100ZNOV03</p>
Antipersonnel Minefield Reinforced with Scatterable Mines with Self-Destruct Date-Time Group		 <p data-bbox="1049 1239 1256 1268">251600ZJUN03</p>
Scatterable Minefield (Antitank Mines) with Self-Destruct Date-Time Group. (See page 1-166 for definition.)		 <p data-bbox="1049 1512 1256 1541">112300ZAPR03</p>
Mined Area		

Table 7-14. Examples of Mobility/Counter-mobility/Survivability Control Measures

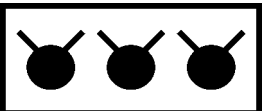
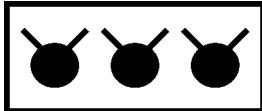

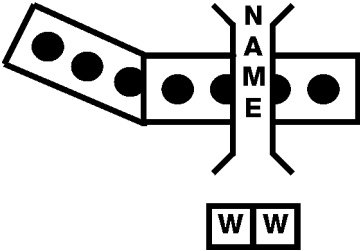
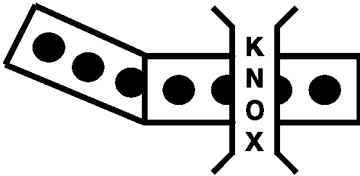
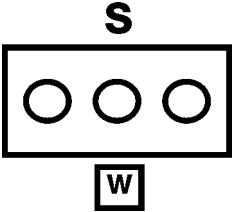
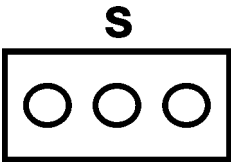
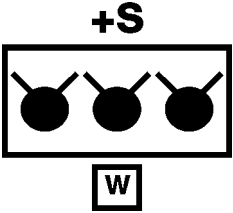
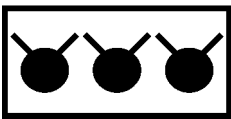
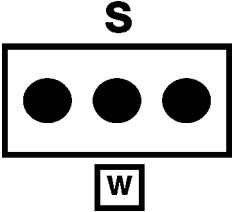
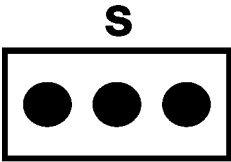
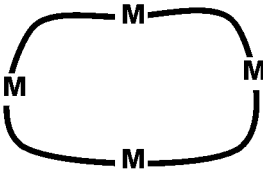
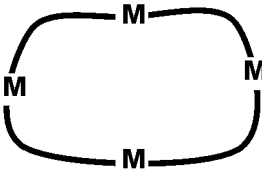

Control Measure	Graphic	Example
Executed Volcano Antitank Minefield	<p style="text-align: center;">VOLCANO</p>  <p style="text-align: center;">22090000LDEC02</p>	
Obstacle Effects		
Block. (See page 1-23 for definition.)		
<p>Note: The vertical line indicates the limit of the enemy advance and the width of the obstacles or where the obstacles tie into untrafficable terrain. The horizontal line is relative to the depth of the obstacles.</p>		
Fix. (See page 1-81 for definition.)		
<p>Note: The irregular part of the symbol indicates where enemy advance is slowed by obstacles.</p>		
Turn. (See page 1-192 for definition.)		
<p>Note: The direction of the arrow indicates desired turn direction.</p>		

Table 7-14. Examples of Mobility/Counter-mobility/Survivability Control Measures



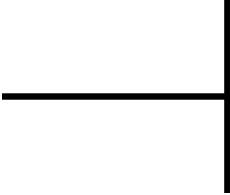
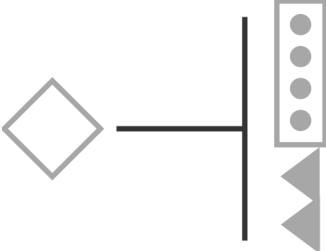

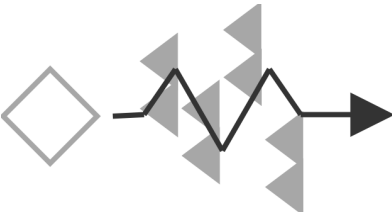
Control Measure	Graphic	Example
<p>Disrupt. (See page 1-63 for definition.)</p>		
<p>Note: The short arrows indicate where obstacles disrupt enemy. The long arrows indicate where bypass is allowed and attacked by fires.</p>		
<p>Obstacle-Free Area</p>		
<p>Obstacle Restricted Area. (See page 1-136 for definition.)</p>		
<p>Unexploded Ordnance Area</p>		
<p>Road Blocks, Craters, and Blown Bridges</p>		
<p>Planned (usually used to close a lane through an antitank ditch or other obstacle)</p>		

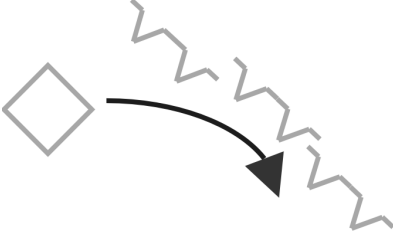
Table 7-14. Examples of Mobility/Counter mobility/Survivability Control Measures



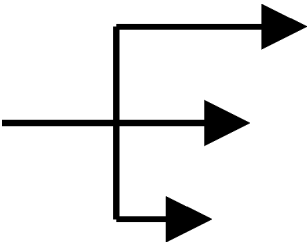
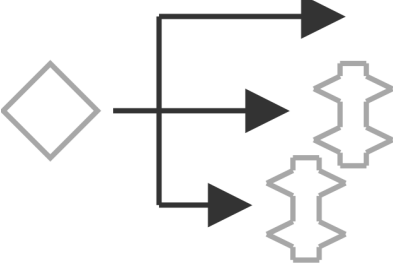
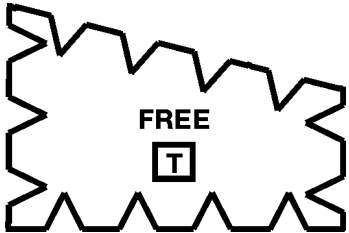

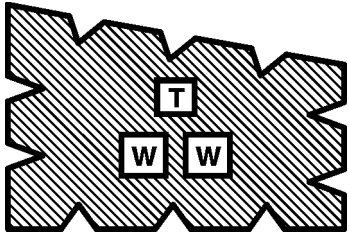
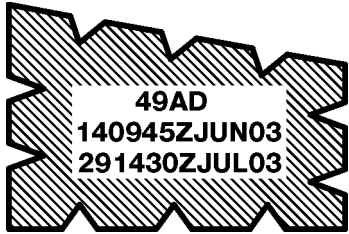

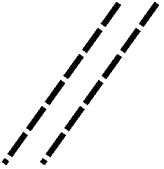
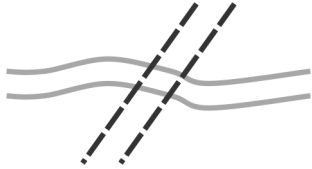

Control Measure	Graphic	Example
Explosives, State of Readiness 1 (safe). (See page 1-176 for definition.)		
Explosives, State of Readiness 2 (armed but passable). (See page 1-176 for definition.)		
Road Block Complete (executed). (See page 1-164 for definition.)		
Trip Wire		
Wire Obstacles		
Unspecified		
Single Fence		
Double Fence		
Double Apron Fence		
Low Wire Fence		

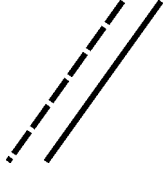
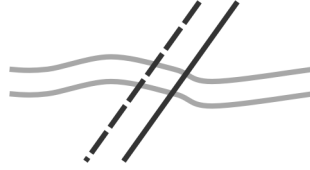
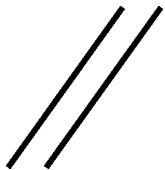
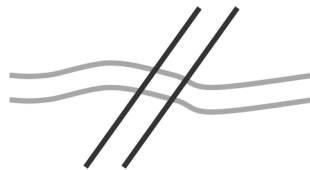
Table 7-14. Examples of Mobility/Counter-mobility/Survivability Control Measures

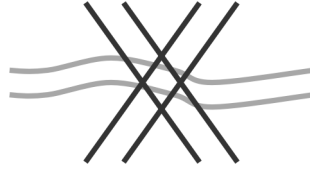
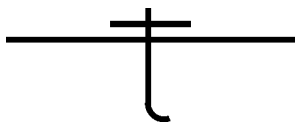
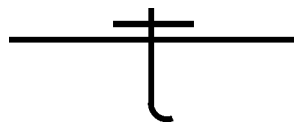
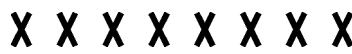



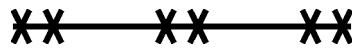
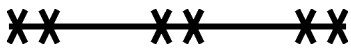
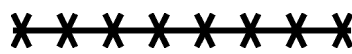
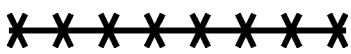





<i>Control Measure</i>	<i>Graphic</i>	<i>Example</i>
High Wire Fence		
Single Strand Concertina		
Double Strand Concertina		
Triple Strand Concertina		
Obstacle Bypass (See page 1-26 for definition.)		
Obstacle Bypass Difficulty (Enemy is moving in the same direction in which the arrow points.)		
Bypass Easy		
Bypass Difficult		

Table 7-14. Examples of Mobility/Counter-mobility/Survivability Control Measures



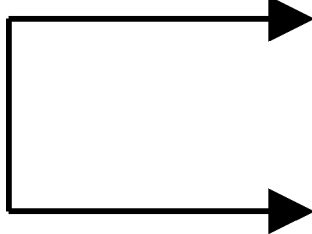
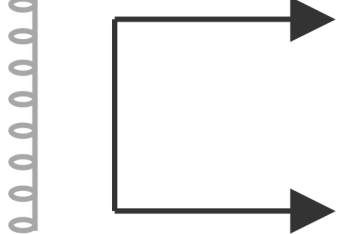
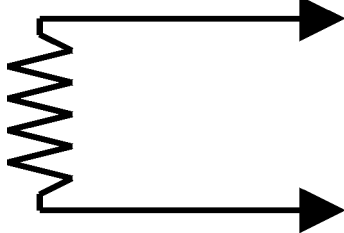

Control Measure	Graphic	Example
Bypass Impossible		
Crossing Sites/Water Crossings (See page 1-50 for definition.)		
Assault Crossing Area		
Bridge or Gap Crossing		
Ferry		

Table 7-14. Examples of Mobility/Counter-mobility/Survivability Control Measures

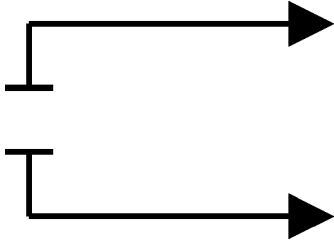
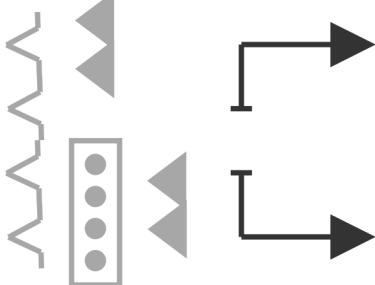
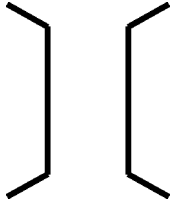
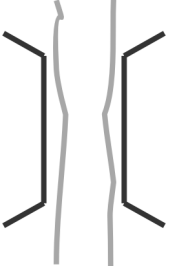
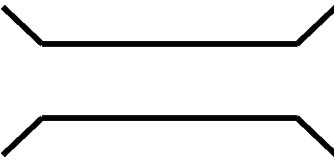

<i>Control Measure</i>	<i>Graphic</i>	<i>Example</i>
Ford/Ford Easy. (See page 1-83 for definition.)		
Ford Difficult		
Lane. (See page 1-109 for definition.)		
Raft Site		

Table 7-14. Examples of Mobility/Counter-mobility/Survivability Control Measures

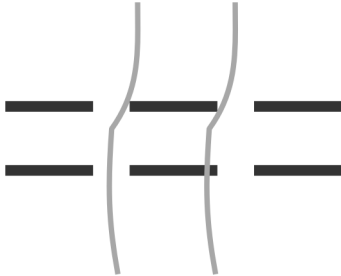
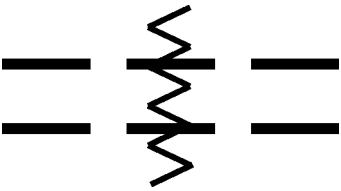
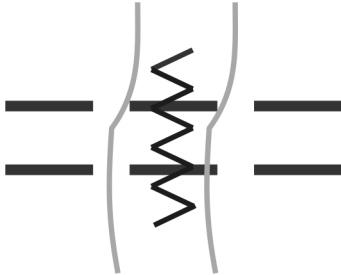

Control Measure	Graphic	Example
Engineer Regulating Point (ERP). (See page 1-71 for definition.)		
Limited Access Area		

Table 7-15. Examples of Survivability Control Measures

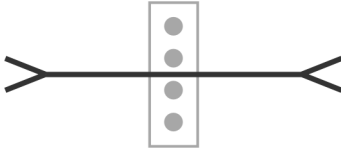
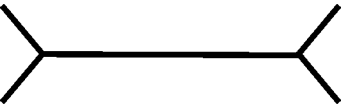
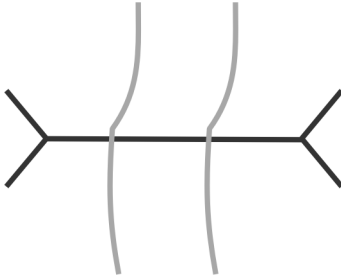



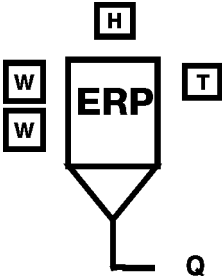

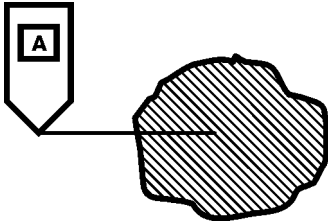
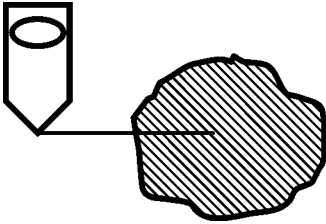
Control Measure	Graphic	Example
Earthwork, Small Trench, or Fortification		
Fort		
Fortified Line		
Foxhole, Emplacement, or Weapon Site. (See page 1-70 for definition.)		

Table 7-15. Examples of Survivability Control Measures



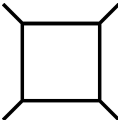
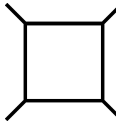

<i>Control Measure</i>	<i>Graphic</i>	<i>Example</i>
Surface Shelter		
Underground Shelter		

Table 7-16. Examples of Nuclear, Biological, and Chemical Control Measures

<i>Control Measure</i>	<i>Graphic</i>	<i>Example</i>
Minimum Safe Distance (MSD) Zones		
Nuclear Detonations Friendly Ground Zero		

Table 7-16. Examples of Nuclear, Biological, and Chemical Control Measures

Control Measure	Graphic	Example
Friendly Planned or On Order		
Enemy Known Ground Zero		
Enemy Templated		

Table 7-16. Examples of Nuclear, Biological, and Chemical Control Measures

Control Measure	Graphic	Example
Fallout Producing		
Biological Attack or Release Event		
Chemical Attack or Release Event		

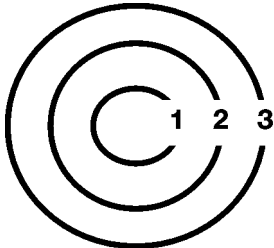
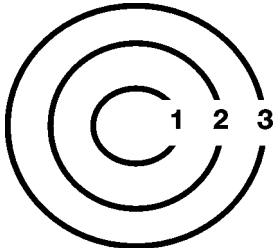
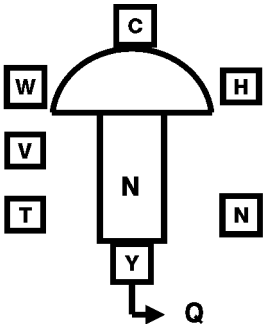
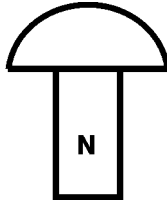
Table 7-16. Examples of Nuclear, Biological, and Chemical Control Measures

Control Measure	Graphic	Example
Radioactive Area	 <p data-bbox="724 753 1208 787">The color yellow is used if available.</p>	
Biologically Contaminated Area	 <p data-bbox="724 1129 1208 1163">The color yellow is used if available.</p>	
Chemically Contaminated Area	 <p data-bbox="724 1501 1208 1535">The color yellow is used if available.</p>	

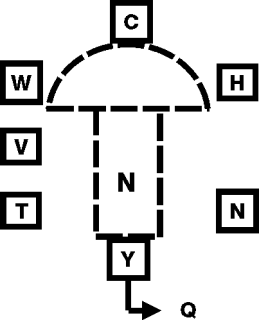
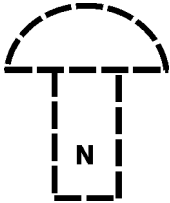
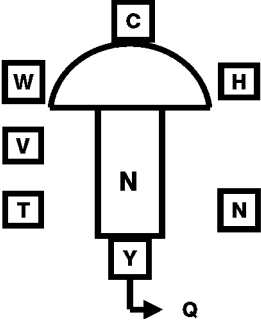
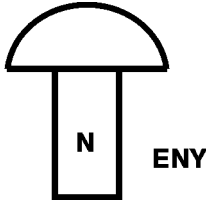
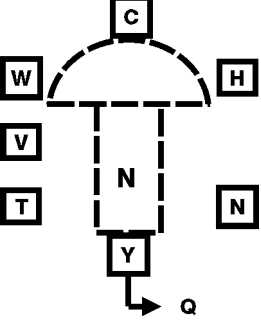
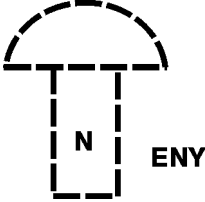
Table 7-16. Examples of Nuclear, Biological, and Chemical Control Measures

Control Measure	Graphic	Example
Decontamination Points (See page 1-54 for definition.)		
Unspecified Decontamination Site/Point (DCN)		
Unspecified Alternate Decontamination Site/Point (DCN ALT)		
Troops Decontamination Site/Point (DCN T)		
Equipment Decontamination Site/Point (DCN E)		

Table 7-16. Examples of Nuclear, Biological, and Chemical Control Measures

Control Measure	Graphic	Example
Equipment and Troops Decontamination Site/Point (DCN E/T)		
Operational Decontamination Site/Point (DCN O)		
Thorough Decontamination Site/Point (DCN T)		
Dose Rate Contour Lines. (See page 1-66 for definition.)		

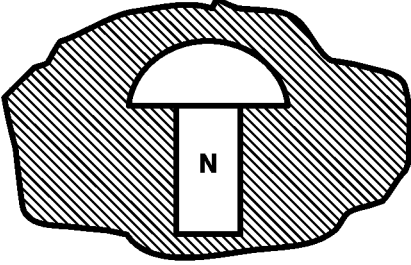
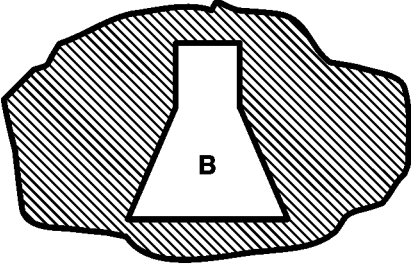
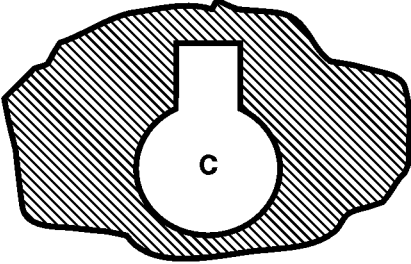
Table 7-17. Examples of Combat Service Support Control Measures

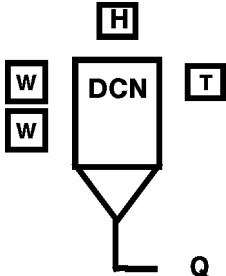
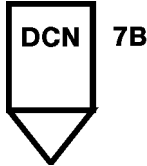
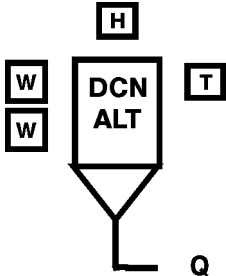
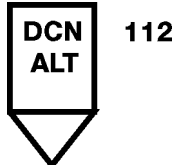
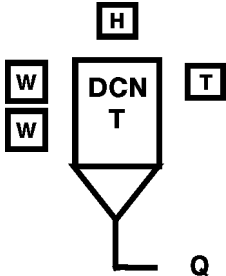
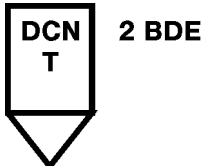
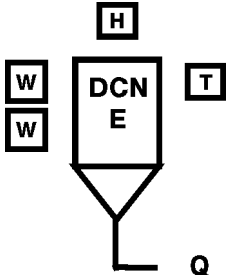
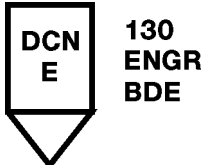

Control Measure	Graphic	Example
<p>Points</p> <p>Ambulance Exchange Point (AXP). (See page 1-9 for definition.)</p>		
<p>Cannibalization Point (CAN)</p>		
<p>Casualty Collection Point (CCP). (See page 1-27 for definition.)</p>		
<p>Civilian Collection Point (CIV)</p>		

Table 7-17. Examples of Combat Service Support Control Measures

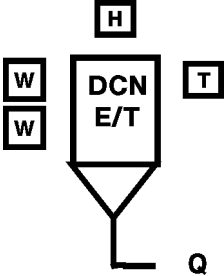
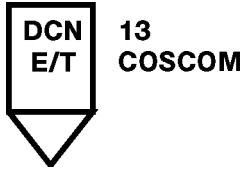
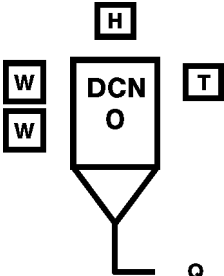
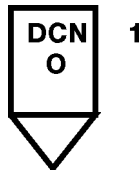
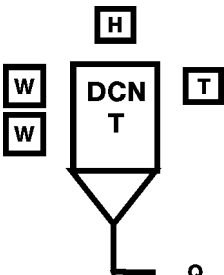
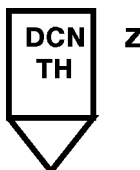
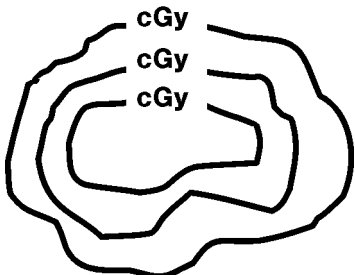
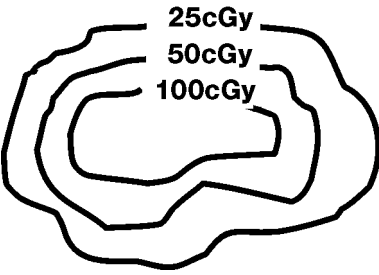

Control Measure	Graphic	Example
Detainee Collection Point (DET)		
Enemy Prisoner of War Collection Point (EPW)		
Logistics Release Point (LRP). (See page 1-115 for definition.)		
Maintenance Collection Point (MCP). (See page 1-117 for definition.)		

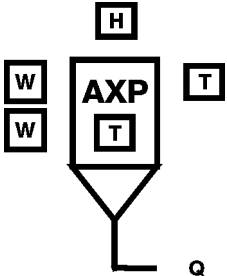
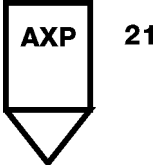
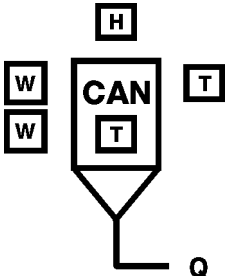
Table 7-17. Examples of Combat Service Support Control Measures

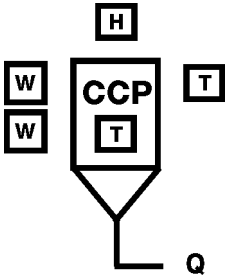
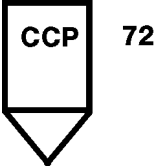
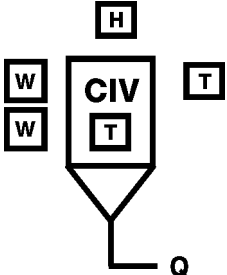
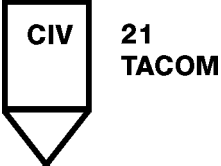



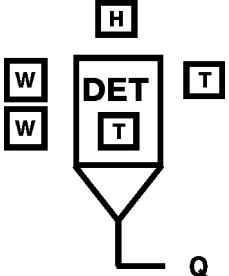
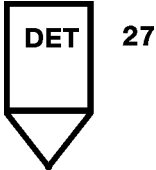
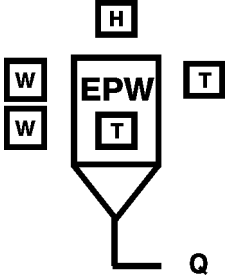

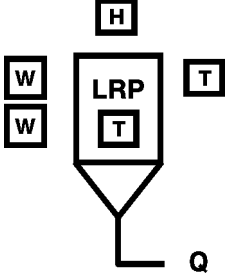
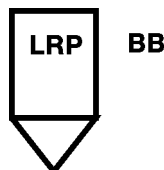
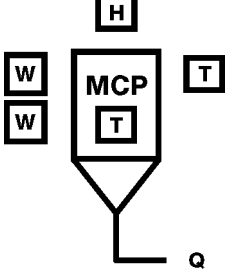
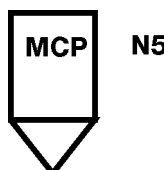

Control Measure	Graphic	Example
Rearm, Refuel, and Resupply Point (R ³ P). (See page 1-157 for definition.)		 3-4 CAV
Refuel on the Move Point (ROM). (See page 1-159 for definition.)		 14E
Traffic Control Post (TCP). (See page 1-191 for definition.)		 221
Trailer Transfer Point (TTP). (See page 1-191 for definition.)		 21D DISCOM

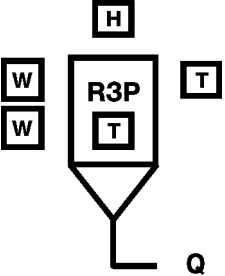
Table 7-17. Examples of Combat Service Support Control Measures

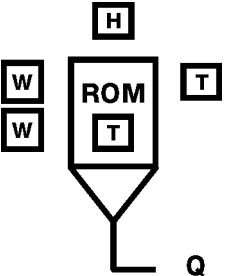

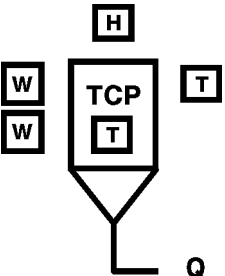

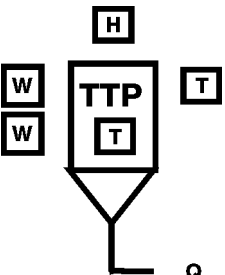

Control Measure	Graphic	Example
<p>Unit Maintenance Collection Point (UMCP). (See page 1-194 for definition.)</p>		 <p>2-39 FA</p>
<p>Supply Points (US only) (See page 1-178 for definition.)</p>		
<p>General/Multiple Classes. (See page 1-31 for definition.)</p>		
<p>Class I NATO Class I</p>		 <p>4</p>
<p>Class II NATO Class II</p>		 <p>891D</p>

Table 7-17. Examples of Combat Service Support Control Measures

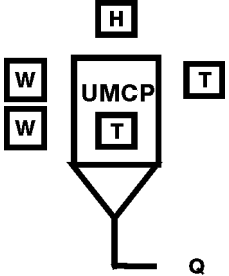

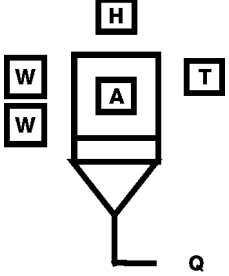
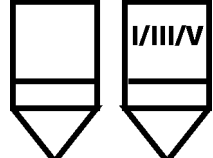
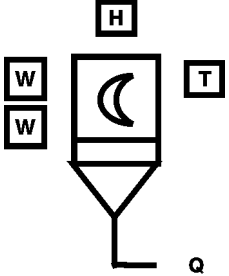

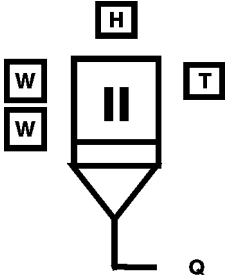

Control Measure	Graphic	Example
Class III NATO Class III		
Class III Aviation NATO Class III		
Class IV NATO Class IV		
Class V NATO Class V		

Table 7-17. Examples of Combat Service Support Control Measures

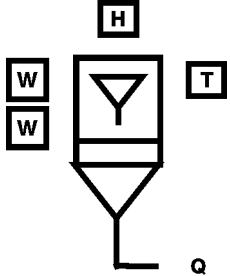
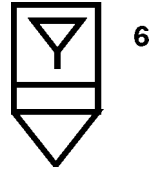
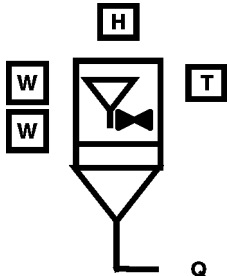
Control Measure	Graphic	Example
Class VI NATO Class I		
Class VII NATO Class II		
Class VIII NATO Class II		
Class IX NATO Class II		

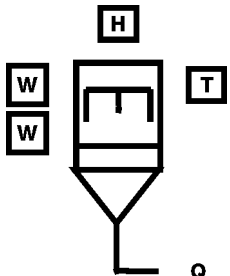
Table 7-17. Examples of Combat Service Support Control Measures

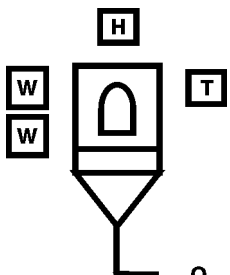

Control Measure	Graphic	Example
<p>Class X</p> <p>NATO Class IV</p>		
Ammunition Points		
<p>Ammunition Supply Point (ASP). (See page 1-10 for definition.)</p>		
<p>Ammunition Transfer Point (ATP). (See page 1-10 for definition.)</p>		
Lines		
Convoys (See page 1-45 for definition.)		
<p>Moving Convoy</p>		

Table 7-17. Examples of Combat Service Support Control Measures

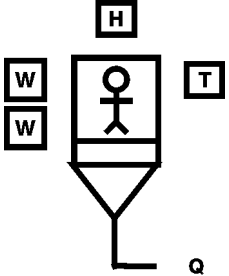
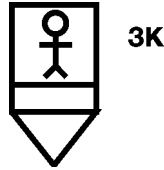
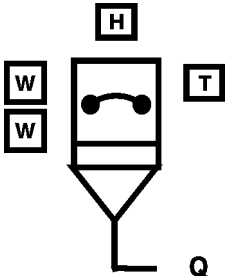
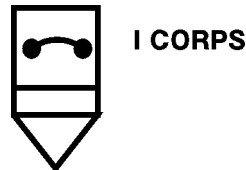
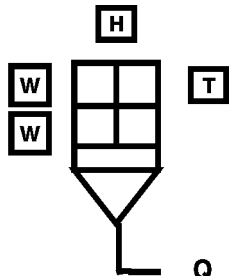
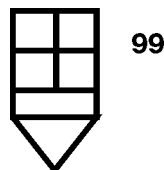
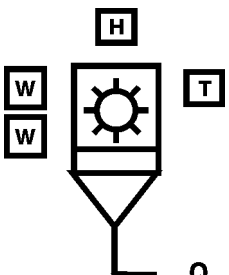
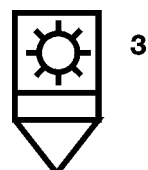



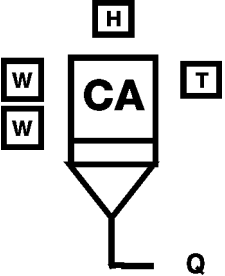
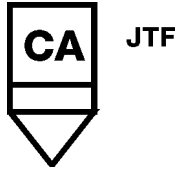
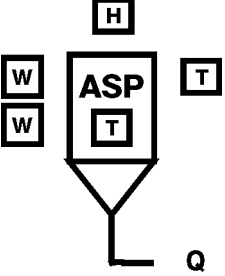
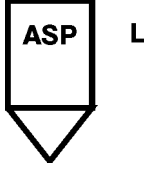
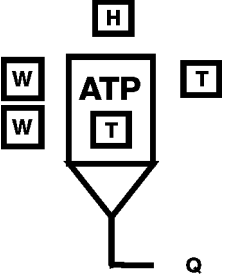
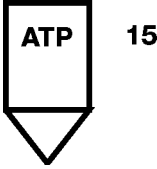
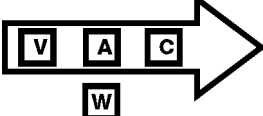



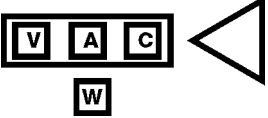

Control Measure	Graphic	Example
Halted Convoy		
Supply Routes		
Main Supply Route (MSR). (See page 1-117 for definition.)	<p style="text-align: center;">MSR NAME</p> 	<p style="text-align: center;">MSR HAIL</p> 
Alternate Supply Route (ASR). (See page 1-9 for definition.)	<p style="text-align: center;">ASR NAME</p> 	<p style="text-align: center;">ASR SLEET</p> 
One-Way Traffic	<p style="text-align: center;">MSR NAME</p> 	<p style="text-align: center;">MSR SNOW</p> 
Alternating Traffic	<p style="text-align: center;">MSR NAME</p> 	<p style="text-align: center;">MSR RAIN</p> 
Two-Way Traffic	<p style="text-align: center;">MSR NAME</p> 	<p style="text-align: center;">MSR WIND</p> 

Table 7-17. Examples of Combat Service Support Control Measures



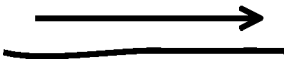

<i>Control Measure</i>	<i>Graphic</i>	<i>Example</i>
Areas		
Detainee Holding Area		
Enemy Prisoner of War (EPW) Holding Area		
Forward Arming and Refuel Point (FARP) (See definition on page 1-84.)		
Refugee Holding Area		
Support Areas (See page 1-179 for definition.)		
Brigade Support Area (BSA). (See page 1-25 for definition.)		

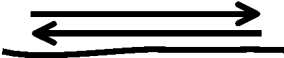
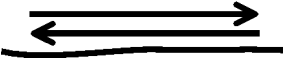
Table 7-17. Examples of Combat Service Support Control Measures

<i>Control Measure</i>	<i>Graphic</i>	<i>Example</i>
Division Support Area (DSA). (See page 1-65 for definition.)		
Regimental Support Area (RSA)		

Chapter 8

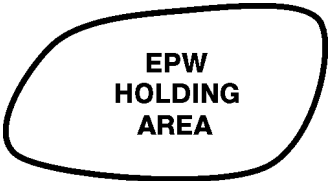
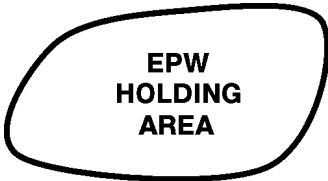
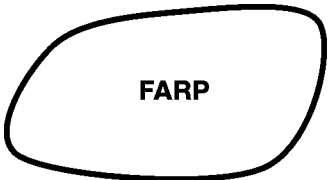
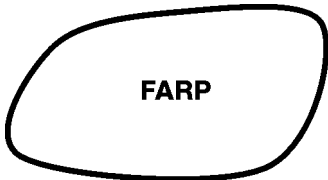
Installation Symbols

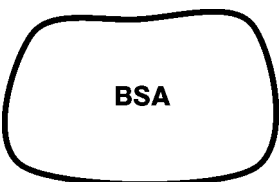
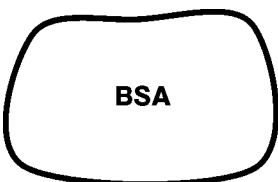
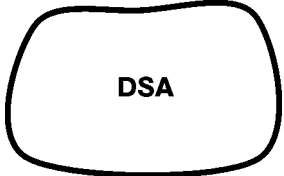
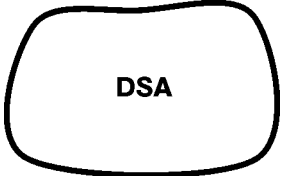
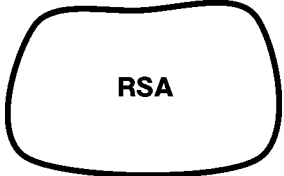
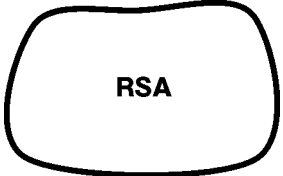
Installations are sites that incorporate permanent, semi-permanent, and temporary structures. This chapter establishes a single standard system for the development of a variety of installation symbols. Avoid using any symbols, or combinations and modifications of symbols different from those in this manual. If, after searching the doctrinal symbols and modifiers in this manual, a new symbol must be created, explain it in an accompanying legend.

COMPOSITION OF INSTALLATION SYMBOLS

8-1. An installation symbol is composed of a frame, color (fill), functional symbol(s) (icon), and text or graphic modifiers (figure 8-1). (See table 8-1, page 8-2, for the steps used to build installation symbols.)

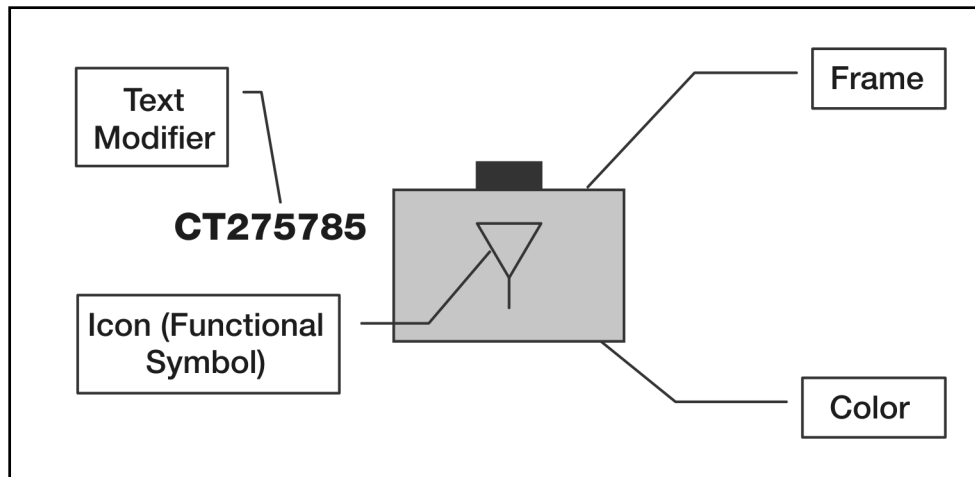
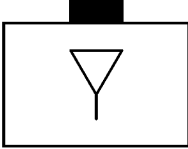

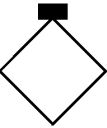



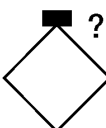
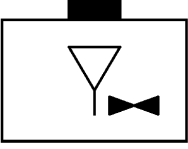
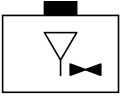

Figure 8-1. Installation Symbol Components

Table 8-1. Building Installation Symbols

Step #	Step	Example					
Step 1.	First, choose the frame that matches the affiliation of the installation (friendly, hostile, neutral). Then choose a functional symbol for field "A." In this example, the affiliation is friendly and the function is petroleum/gas/oil.	 Friendly Petroleum/Gas/Oil					
Installation Frame Shapes and Affiliation							
Affiliation	Friendly	Hostile	Neutral	Unknown	Pending	Assumed Friend	Suspect
Frame							
Steps 2-4.	Choose the second/third/fourth functional symbol modifier that further explains the capability of that installation, modifying field "A." In this example, the second functional symbol modifier is "aviation."	 Friendly Aviation Petroleum/Gas/Oil					
Step 5.	Choose text or graphic symbol modifier as necessary to provide further amplifying information. In this example, there are two text modifiers, the first is installation composition (field "AI"), which is PRODUCTION/STORAGE, and the second is capacity of installation (field "K"), which is 100,000 gallons (100K GAL).	<p>PRODUCTION/STORAGE</p>  <p style="text-align: right;">100K GAL</p> <p>Friendly Aviation Petroleum/Gas/Oil Production/Storage Installation</p>					

INSTALLATION SYMBOL MODIFIER FIELDS

8-2. Figure 8-2 shows the placement of installation labeling fields around the friendly land installation symbol frame. The placement of installation symbol modifier fields is the same regardless of frame shape or affiliation.

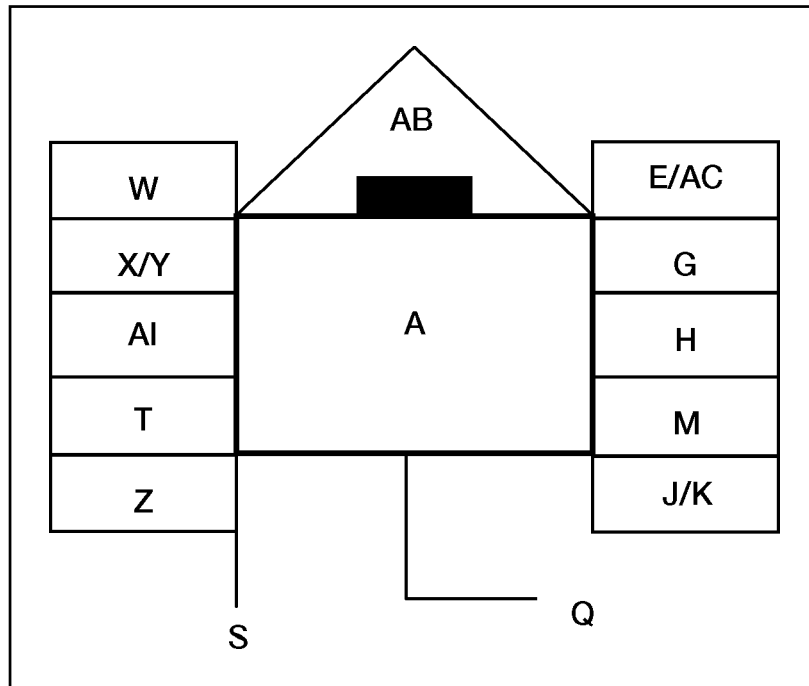

Figure 8-2. Installation Symbol Modifier Fields

8-3. Table 8-2 provides a description of each of the installation symbol modifier fields as shown in figure 8-2.

Table 8-2. Graphic Modifiers for Installation Symbols

<i>Field</i>	<i>Field Title</i>	<i>Description</i>	<i>Text/Graphic</i>
A	Symbol	Basic installation symbol that can include capability modifiers. (See table 8-3, page 8-6.)	Both
E	Suspect or Assumed Friend	Question mark “?” represents suspect or assumed friend.	Text
G	Staff Comments	Free text. Can be used by staff for information required by commander.	Text
H	Additional Information	Free text. For installations, this field is used to describe the specific nature of the installation, such as production, processing, or storage.	Text

Table 8-2. Graphic Modifiers for Installation Symbols

<i>Field</i>	<i>Field Title</i>	<i>Description</i>	<i>Text/Graphic</i>
J	Evaluation Rating	<p>Degree of confidence that may be placed on the information represented by the symbol. It is shown as one letter and one number made up of Reliability of Source and Credibility of Information.</p> <p>Reliability of Source:</p> <p>A. Completely reliable B. Usually reliable C. Fairly reliable D. Not usually reliable E. Unreliable F. Reliability cannot be judged</p> <p>Credibility of Information:</p> <p>1. Confirmed by other sources 2. Probably true 3. Possibly true 4. Doubtful 5. Improbable 6. Truth cannot be judged</p>	Text
K	Capacity of Installation	Capacity of installation displayed.	Text
M	Higher Formation	Number or title of higher echelon command.	Text
Q	Offset Location Indicator	Used to denote precise location of installation or to declutter multiple installation locations (see chapter 5, figure 5-6, page 5-42), except for headquarters (see field S).	Graphic
S	Headquarters Staff Indicator/Offset Location Indicator	Used to indicate precise location of headquarters or to declutter multiple headquarters locations (see figure 5-7, page 5-42).	Graphic
T	Unique Designation	An alphanumeric designator that uniquely identifies a particular installation (name).	Text

Table 8-2. Graphic Modifiers for Installation Symbols

<i>Field</i>	<i>Field Title</i>	<i>Description</i>	<i>Text/Graphic</i>
W	Date-Time Group	An alphanumeric designator for displaying a date-time group (DDHHMMSSZMONYY) or "O/O" for on order. The date-time group is composed of a group of six numeric digits with a time zone suffix and the standardized three-letter abbreviation for the month followed by two digits. The first pair of digits represents the day; the second pair, the hour; the third pair, the minutes. The last two digits of the year are after the month. For automated systems, two digits may be added before the time zone suffix and after the minutes to designate seconds.	Text
X	Altitude/Depth	Height in feet of equipment or structure on the ground.	Text
Y	Location	Latitude and longitude or grid coordinates.	Text
Z	Speed	Displays speed in nautical miles per hour or kilometers per hour.	Text
AB	Feint or Dummy Indicator	Indicates that it is a dummy for deception purposes.	Graphic
AC	Country Indicator	A two-letter code that indicates the country of origin of the unit. This field can be used also for factions or groups in SO/SO.	Text
AI	Installation Composition	Indicates the composition of the installation, such as production, service, storage, research, or utility.	Text

Table 8-3. Field A: Installation Function









































Installation Function	Friend	Hostile	Neutral	Unknown
Installation				
Aircraft				
Aircraft Civilian Fixed Wing				
Aircraft Civilian Rotary Wing				
Aircraft Military Fixed Wing				
Aircraft Military Fixed Wing Bomber (B)				
Aircraft Military Rotary Wing				
Aircraft Unmanned Aerial Vehicle				
Airport/Airbase				
Ammunition and Explosives				

Table 8-3. Field A: Installation Function









































Installation Function	Friend	Hostile	Neutral	Unknown
Atomic Energy Reactor				
Electric Power				
Electric Power Hydroelectric				
Engineering Equipment				
Engineering Equipment Bridge				
Government Leadership				
Ground Vehicle				
Howitzer				
Medical Facility				
Medical Facility Hospital				

Table 8-3. Field A: Installation Function





















































































Installation Function	Friend	Hostile	Neutral	Unknown
Military Base/Facility				
Missile Systems				
Mine				
Nuclear, Biological, Chemical (NBC)				
NBC Biological				
NBC Chemical				
NBC Nuclear				
NBC Decontamination				
Petroleum/Gas/Oil				
Police Station				

Table 8-3. Field A: Installation Function

Installation Function	Friend	Hostile	Neutral	Unknown
Railyard/Railroad Station				
Seaport				
Ship Yard				
Tank				
Telecommunications				
Telecommunications Radio				
Telecommunications Telephone				
Telecommunications Television				
Vehicle Maintenance				
Vehicle				
Water Services				

Chapter 9

Stability Operations and Support Operations Symbols

This chapter establishes a single standard for the development of stability operations and support operations symbols. Joint doctrine uses the term “military operations other than war (MOOTW)” and NATO uses the term “Non-Article 5 Crisis Response Operations (CRO)” for stability operations and support operations. These symbols represent stability operations and support operations activities, locations, and nonmilitary organizations. This chapter includes a wide variety of stability operations and support operations symbols. Avoid using any symbols, or combinations and modifications of symbols, different from those in this manual. If, after searching doctrinal symbols and modifiers, a new symbol must be created, explain it in an accompanying legend. Computer-generated systems may have difficulty in passing nonstandard symbols.

COMPOSITION OF STABILITY OPERATIONS AND SUPPORT OPERATIONS SYMBOLS

9-1. A stability operations and support operations symbol is composed of a frame, color (fill), stability operations and support operations symbol (icon), and text or graphic modifiers (see figure 9-1). See table 9-1, page 9-2, for the steps used to build stability operations and support operations symbols.

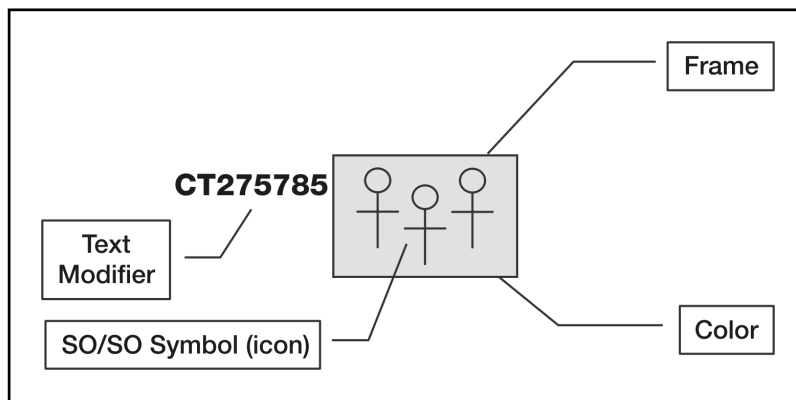
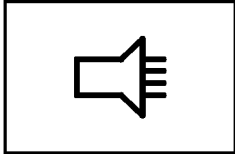

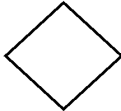



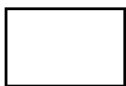
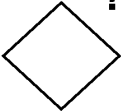
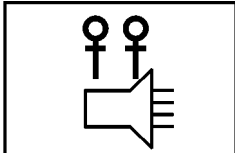
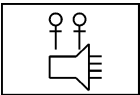

Figure 9-1. Stability Operations and Support Operations Symbol Components

Table 9-1. Building Stability Operations and Support Operations Symbols

Step #	Step	Example					
<p>Step 1.</p>	<p>First, choose the frame that matches the affiliation of the stability operations and support operations organization or situation (friendly, hostile, neutral). Then choose the basic stability operations and support operations symbol for field “A” (see figure 9-2; table 9-2, page 9-3; and table 9-3, page 9-6). In this example, the affiliation is friendly and the situation is “psychological operations.” (See the following stability operations and support operations land frame shapes and affiliations.)</p>	<div style="text-align: center;">  <p>Friendly Psychological Operations</p> </div>					
<p>Stability Operations and Support Operations Land Frame Shapes and Affiliation</p>							
<p>Affiliation</p>	<p>Friendly</p>	<p>Hostile</p>	<p>Neutral</p>	<p>Unknown</p>	<p>Pending</p>	<p>Assumed Friend</p>	<p>Suspect</p>
<p>Frame</p>							
<p>Steps 2-4.</p>	<p>Choose the second/third/fourth functional symbol modifier that further explains the capability of that stability operations and support operations symbol, modifying field “A.” In this example, the secondary function symbol modifier is “person-to-person psychological operations” (see table 9-3, page 9-6).</p>	<div style="text-align: center;">  <p>Friendly Person-to-Person Psychological Operations</p> </div>					
<p>Step 5.</p>	<p>Choose text modifiers as necessary to provide further amplifying information. In this example, the text modifier is the location (field “Y”) of where the person-to-person psychological operations are being conducted.</p>	<div style="text-align: center;"> <p>CT275785</p>  <p>Friendly Person-to-Person Psychological Operations</p> </div>					

STABILITY OPERATIONS AND SUPPORT OPERATIONS SYMBOL MODIFIER FIELDS

9-2. Figure 9-2 shows the placement of stability operations and support operations labeling fields around the friendly land stability operations and support operations symbol frame. The placement of unit symbol modifier fields is the same regardless of frame shape or affiliation.

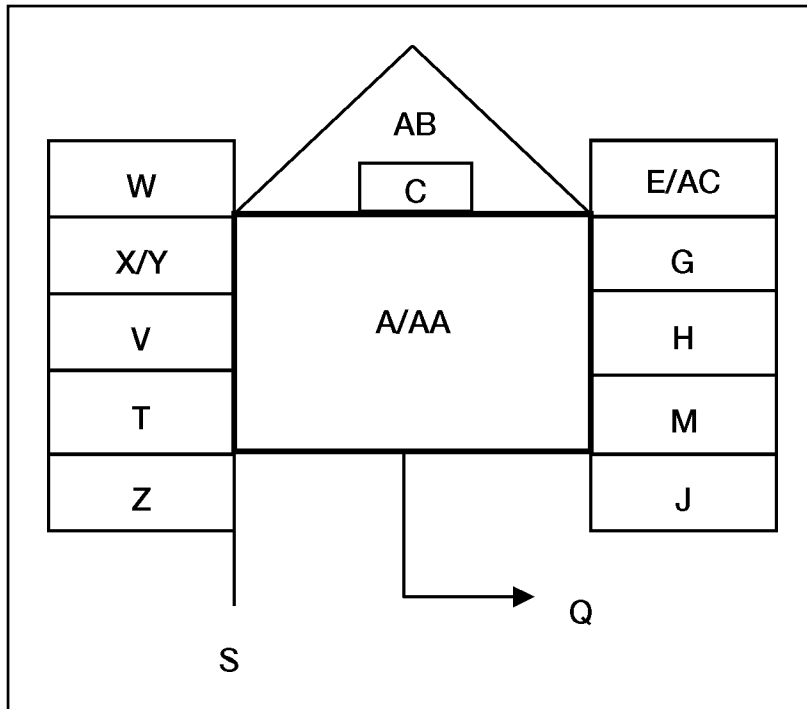

Figure 9-2. Stability Operations and Support Operations Symbol Modifier Fields

9-3. Table 9-2 describes each of the stability operations and support operations symbol modifier fields as shown in figure 9-2.

Table 9-2. Descriptions of Fields for Text or Graphic Modifiers for Stability Operations and Support Operations Symbols

<i>Field</i>	<i>Field Title</i>	<i>Description</i>	<i>Text/Graphic</i>
A	Symbol	Basic stability operations and support operations symbol describing the function of the SO/SO activities, locations, and nonmilitary organizations.	Both
C	Quantity	Identifies the number of activities at that location.	Text
E	Frame Shape Modifier	Helps determine affiliation or battle dimension of symbol. "U" represents unknown battle dimension. Question mark "?" represents suspect or assumed friend.	Text
G	Staff Comments	Free text. Can be used by staff for information required by commander.	Text

Table 9-2. Descriptions of Fields for Text or Graphic Modifiers for Stability Operations and Support Operations Symbols

<i>Field</i>	<i>Field Title</i>	<i>Description</i>	<i>Text/Graphic</i>
H	Additional Information	Free text. Additional information not covered by other fields.	Text
J	Evaluation Rating	<p>Degree of confidence that may be placed on the information represented by the symbol. It is shown as one letter and one number made up of Reliability of Source and Credibility of Information.</p> <p>Reliability of Source:</p> <p>A. Completely reliable B. Usually reliable C. Fairly reliable D. Not usually reliable E. Unreliable F. Reliability cannot be judged</p> <p>Credibility of Information:</p> <p>1. Confirmed by other sources 2. Probably true 3. Possibly true 4. Doubtful 5. Improbable 6. Truth cannot be judged.</p>	Text
M	Higher Formation	Title of a higher level or affiliated organization being represented.	Text
Q	Direction of Movement Arrow/Offset Location Indicator	With arrow, it denotes the direction symbol is moving or will move. Without arrow, it is used to denote precise location or to declutter. (See figure 5-7, page 5-42.)	Graphic
S	Headquarters Staff Indicator	Identifies symbol as a headquarters.	Graphic
	Offset Location Indicator	Used to indicate precise location of headquarters or to declutter multiple headquarters locations (see chapter 5).	
T	Unique Designation	An alphanumeric title that uniquely identifies a particular symbol.	Text
V	Type of Equipment	Identifies unique designation.	Text

Table 9-2. Descriptions of Fields for Text or Graphic Modifiers for Stability Operations and Support Operations Symbols

<i>Field</i>	<i>Field Title</i>	<i>Description</i>	<i>Text/Graphic</i>
W	Date-Time Group	An alphanumeric designator for displaying a date-time group (DDHHMMSSZMONYY) or "O/O" for on order. The date-time group is composed of a group of six numeric digits with a time zone suffix and the standardized three-letter abbreviation for the month followed by two digits. The first pair of digits represents the day; the second pair, the hour; the third pair, the minutes. The last two digits of the year are after the month. For automated systems, two digits may be added before the time zone suffix and after the minutes to designate seconds.	Text
X	Altitude/Depth	Altitude as displayed on the global positioning system (GPS).	Text
		Height in feet of equipment or structure on the ground.	
Y	Location	Latitude and longitude or grid coordinates.	Text
Z	Speed	Displays speed in nautical miles per hour or kilometers per hour.	Text
AA	Named SO/SO Nonmilitary Organizations	Can be used to indicate international organizations (UN) or (ICRC/RC), nongovernment organizations (NGO), national governmental agencies (USAID), or regional intragovernmental organizations (EU).	Text
AB	Feint or Dummy Indicator	Indicates that it is a dummy or a feint for deception purposes.	Graphic
AC	Country Indicator	A two-letter code that indicates the country of origin of the unit. (See chapter 2.) This field can be used also for factions or groups in SO/SO. (Names of factions or groups must be spelled out.)	All

Table 9-3. Field AA: Stability Operations and Support Operations Activities, Locations, and Nonmilitary Organizations





































Type	Friendly	Hostile	Neutral	Unknown
Activities				
Arrest				
Arson				
Computer Network Attack (CNA)				
Fire				
Assassination				
Execution				
Murder				
Bomb/Bombing				
Booby Trap Note: By placing the frame around the GCM (chapter 7), it becomes an event.				

Table 9-3. Field AA: Stability Operations and Support Operations Activities, Locations, and Nonmilitary Organizations









































Type	Friendly	Hostile	Neutral	Unknown
Demonstration				
Drive-By Shooting				
Electronic Warfare Intercept <small>Note: Same as Electronic Warfare Intercept under Military Intelligence in chapter 5.</small>				
Extortion <small>Note: Other currency symbols may also be used, such as for the Euro.</small>				
Foraging/Searching				
Graffiti				
Kidnapping				
Patrolling				
Poisoning				
<i>Hijacking</i>				
Vehicle Hijacking				

Table 9-3. Field AA: Stability Operations and Support Operations Activities, Locations, and Nonmilitary Organizations

Type	Friendly	Hostile	Neutral	Unknown
Air Hijacking				
Airplane Hijacking				
Helicopter Hijacking				
Sea Surface Hijacking				
Leisure Craft Hijacking				
Merchant Hijacking				
Psychological Operations				
Psychological Operations Note: Same as Psychological Operations in chapter 5.				
Psychological Operations Distribution Center				
Psychological Operations Face-to-Face				
Psychological Operations Loudspeaker Broadcast				
Psychological Operations Broadcast Aerial (Fixed Wing) Station				

















































Table 9-3. Field AA: Stability Operations and Support Operations Activities, Locations, and Nonmilitary Organizations

Type	Friendly	Hostile	Neutral	Unknown
Psychological Operations Loudspeaker Broadcast Helicopter (Rotary Wing) Mounted				
Psychological Operations Loudspeaker Broadcast Wheeled Vehicle Mounted				
Psychological Operations Printing Service				
Psychological Operations Radio Broadcast				
Psychological Operations Target Audience Location				
Psychological Operations Television Broadcast				
Psychological Operations Written				
Psychological Operations Written (Leaflets) Aerial (Fixed Wing) Dropped				
Psychological Operations Written (Leaflets) Helicopter (Rotary Wing) Dropped				
<i>Recruitment</i>				
Willing Recruitment (W)				

Table 9-3. Field AA: Stability Operations and Support Operations Activities, Locations, and Nonmilitary Organizations

Type	Friendly	Hostile	Neutral	Unknown
Coerced/Impressed Recruitment (C)				
Riot				
Sniping				
Locations				
Ammunition Cache Note: Same as Class V Supply in chapter 5.				
Drug Operation				
Food Distribution Note: Same as Class I Supply in chapter 5.				
Mass Grave Site				
<i>List Locations</i>				
Black List Location				
Gray List Location				
White List Location				

Table 9-3. Field AA: Stability Operations and Support Operations Activities, Locations, and Nonmilitary Organizations

Type	Friendly	Hostile	Neutral	Unknown
Medical Treatment Facility Note: Same as Medical Treatment Facility in chapter 5.				
Radio				
Radio Station				
Supply Cache Note: Same as Supply in chapter 5.				
Television Station				
Nonmilitary Organizations				
Civilian Helicopter Note: Same as civilian helicopter for air equipment in MS-2525.				
Drug Vehicle				
Known Insurgent Vehicle (Black List Vehicle)				
Media				
Refugees				
Safe House				
Spy				

Appendix A

Tactical Mission Graphics

Tactical mission graphics are used in course-of-action sketches, synchronization matrixes, and maneuver sketches. They do not replace any part of the operation order. The graphics in this appendix are representations of many of the tactical mission tasks. Not all tactical mission tasks have an associated graphic. Tactical mission graphics should be scaled to fit the map scale and size of unit for which they are used. Where practical, the tactical mission graphic should connect with the decision graphic at the center of the left or right side of the symbol or at the center of the bottom of the symbol, depending on the orientation of the graphics. See figure A-1, page A-7, for an example of decision graphics and tactical mission graphics used together. For information on building decision graphics, see appendix D. **In the examples shown in table A-1, the hostile force would be located to the right of the symbol. However, these graphics can be oriented in any direction relative to the position of hostile forces.**

Note: Those tactical mission graphics that are defined in the terminology section of this manual are identified with a page number where the definition can be found. A detailed explanation of each tactical mission task can be found in FM 3-90.

Table A-1. Examples of Tactical Mission Graphics



Tactical Mission Task	Graphic
Block. (See page 1-23 for definition.)	
Breach. See page 1-24 for definition.)	
Bypass. (See page 1-26 for definition.)	
Canalize. (See page 1-27 for definition.)	
Clear. (See page 1-32 for definition.)	
Contain. (See page 1-43 for definition.)	

Table A-1. Examples of Tactical Mission Graphics

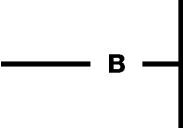
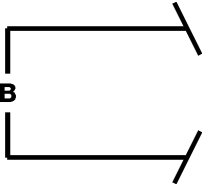
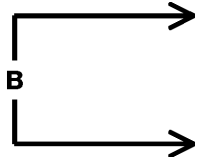
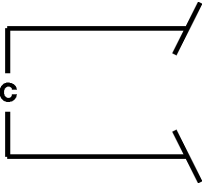
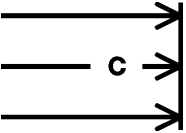

Tactical Mission Task	Graphic
Counterattack (CATK). (See page 1-46 for definition.)	
Counterattack By Fire	
Delay. (See page 1-56 for definition.)	
Delay (until a specified time)	
Destroy. (See page 1-59 for definition.)	
Disrupt. (See page 1-63 for definition.)	
Fix. (See page 1-81 for definition.)	

Table A-1. Examples of Tactical Mission Graphics

Tactical Mission Task	Graphic
Follow and Assume. (See page 1-82 for definition.)	
Follow and Support. (See page 1-82 for definition.)	
Interdict. (See page 1-103 for definition.)	
Isolate. (See page 1-105 for definition.)	
Neutralize. (See page 1-132 for definition.)	
Occupy. (See page 1-136 for definition.)	
Passage of Lines (Forward). (See page 1-142 for definition.)	

Table A-1. Examples of Tactical Mission Graphics

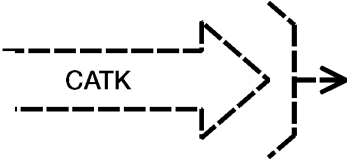
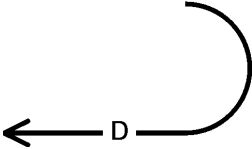
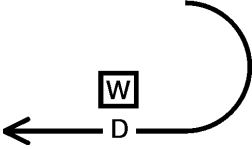
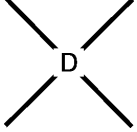
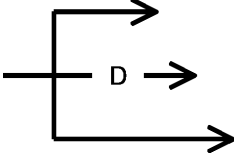

Tactical Mission Task	Graphic
Passage of Lines (Rearward)	
Penetration. (See page 1-145 for definition.)	
Relief In Place (RIP). (See page 1-160 for definition.)	
Retain. (See page 1-163 for definition.)	
Retirement. (See page 1-163 for definition.)	
Secure. (See page 1-168 for definition.)	
Security (screen). (See page 1-167 for definition.)	

Table A-1. Examples of Tactical Mission Graphics

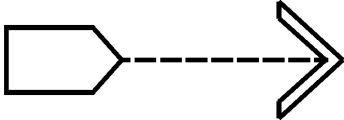
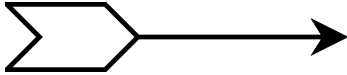
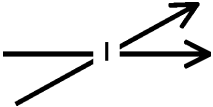
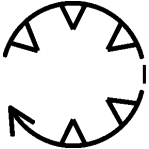
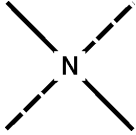
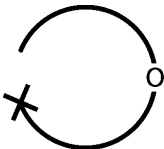
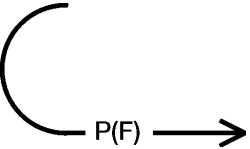
Tactical Mission Task	Graphic
Security (guard). (See page 1-90 for definition.)	
Security (cover). (See page 1-48 for definition.)	
Seize. (See page 1-168 for definition.)	
Suppress. (See page 1-179 for definition.)	
Turn. (See page 1-192 for definition.)	
Withdraw	
Withdraw Under Pressure	

A-1. Figure A-1 is an example of the use of decision graphics and tactical mission graphics. Figure A-1 displays the 3d Brigade, 4th Infantry Division (mechanized), task-organized with two mechanized infantry battalions, an armor battalion, and an attack helicopter battalion. It has no problems. Its

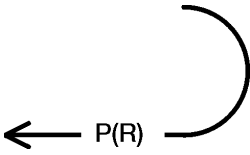
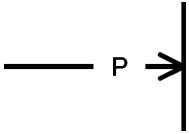
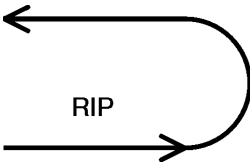
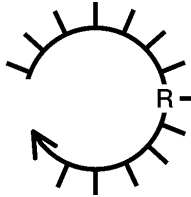
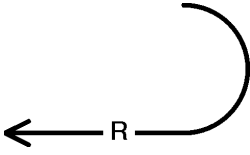
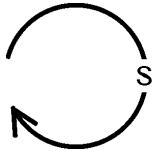
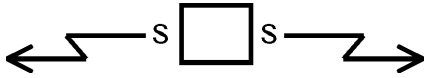
task is to seize Objective Bell. It also displays the 1st Brigade, 4th Infantry Division (mechanized), task-organized with two mechanized infantry battalions and two armor battalions. Its task is to follow and support the 3d Brigade.

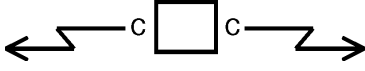
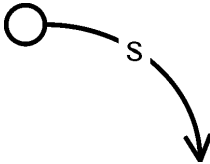
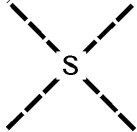
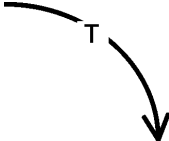
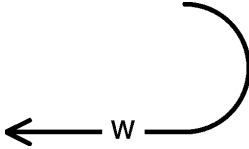
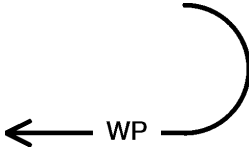
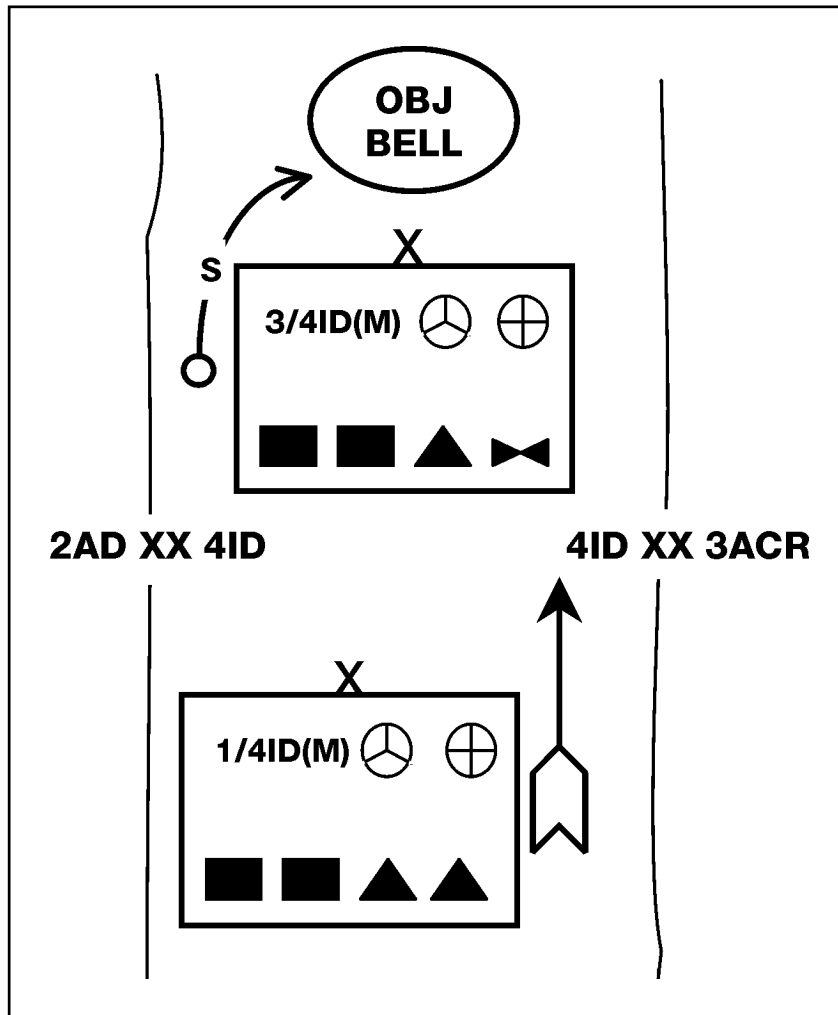

Figure A-1. Example of Decision Graphics and Tactical Mission Graphics

Appendix B

Examples of Military Symbols

The figures in this appendix show examples of unit symbols:

- Figures B-1 through B-6—symbols for divisions.
- Figure B-7—symbols for Marine divisions.
- Figure B-8—symbols for Stryker brigade combat teams.
- Figure B-9—symbols for supply sites.
- Figure B-10—symbols for combat service support units.
- Figure 11—unit symbols with labeling fields.
- Figure B-12—equipment symbols with labeling fields.
- Figure B-13—installation symbols with labeling fields.
- Figure B-14—stability operations and support operations symbols with labeling fields.

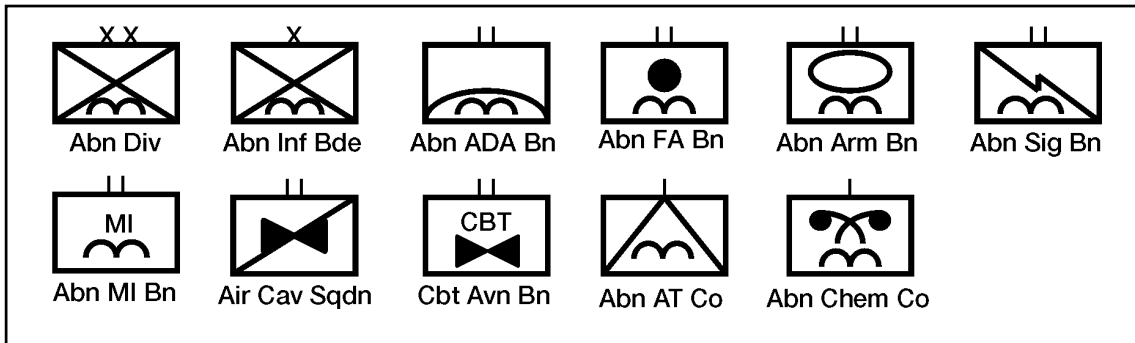

Figure B-1. Airborne Infantry Divisions

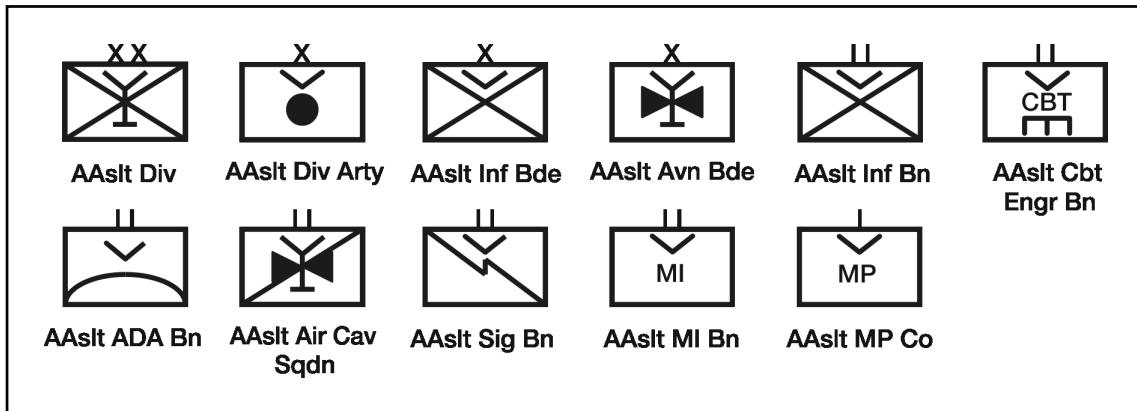

Figure B-2. Air Assault Infantry Divisions

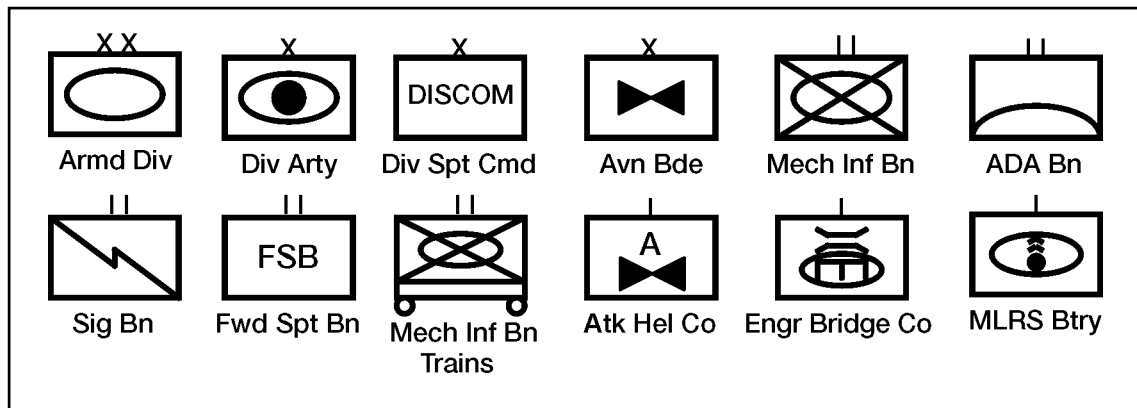

Figure B-3. Armored Divisions

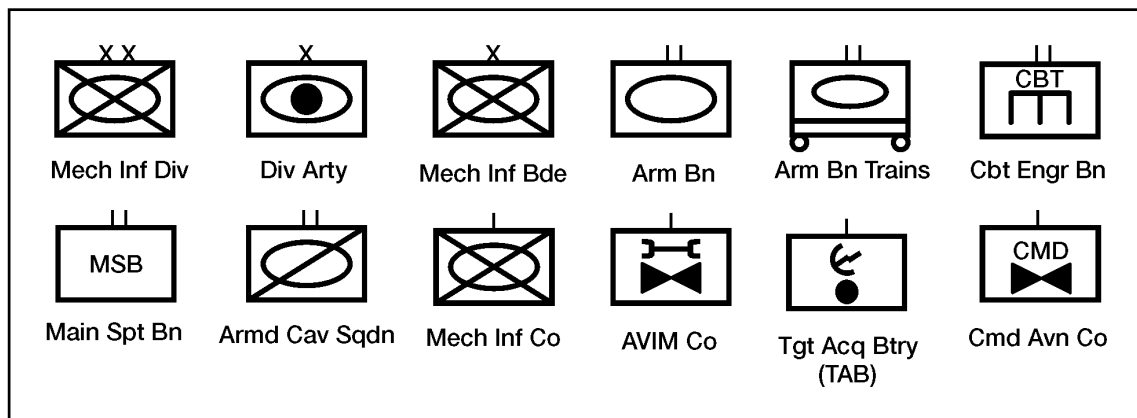

Figure B-4. Mechanized Infantry Divisions

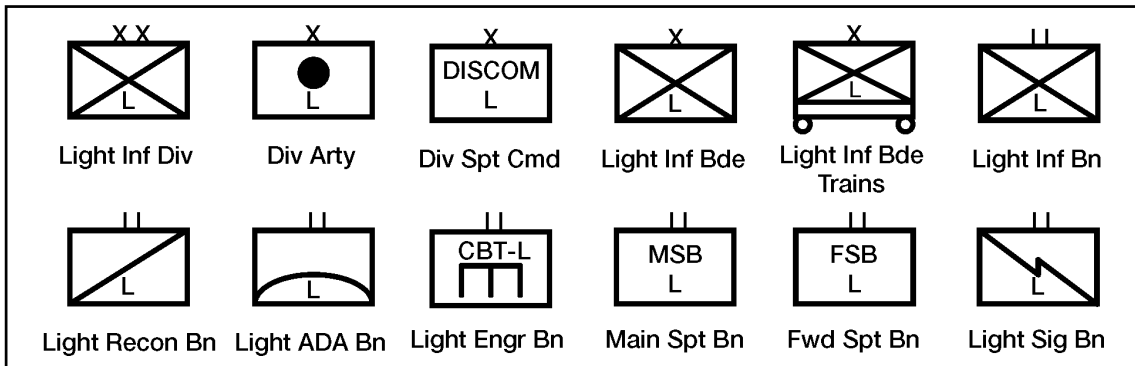

Figure B-5. Light Infantry Divisions

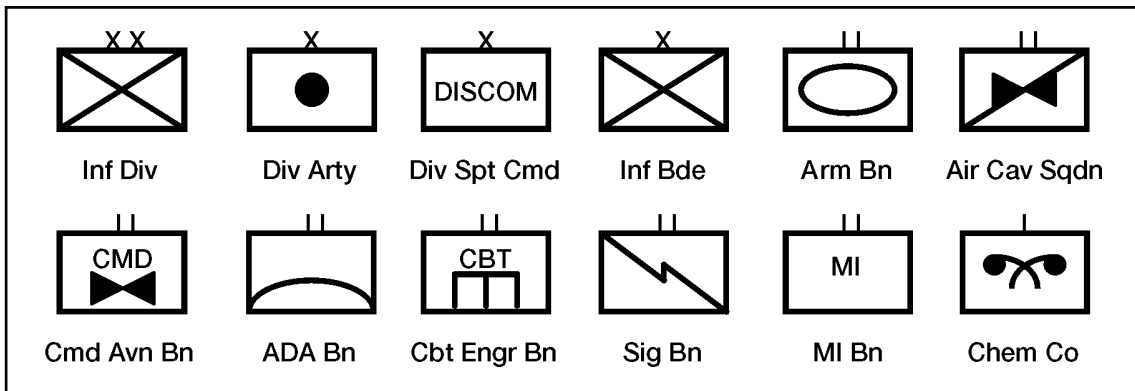

Figure B-6. Infantry Divisions

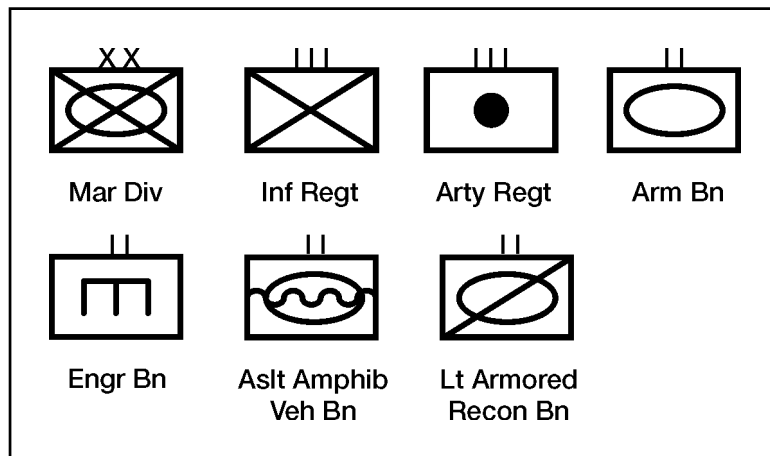

Figure B-7. Marine Divisions

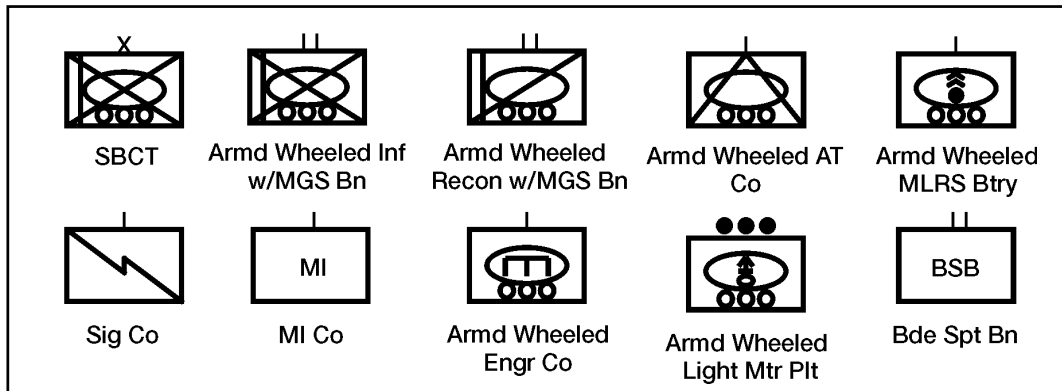

Figure B-8. Stryker Brigade Combat Teams

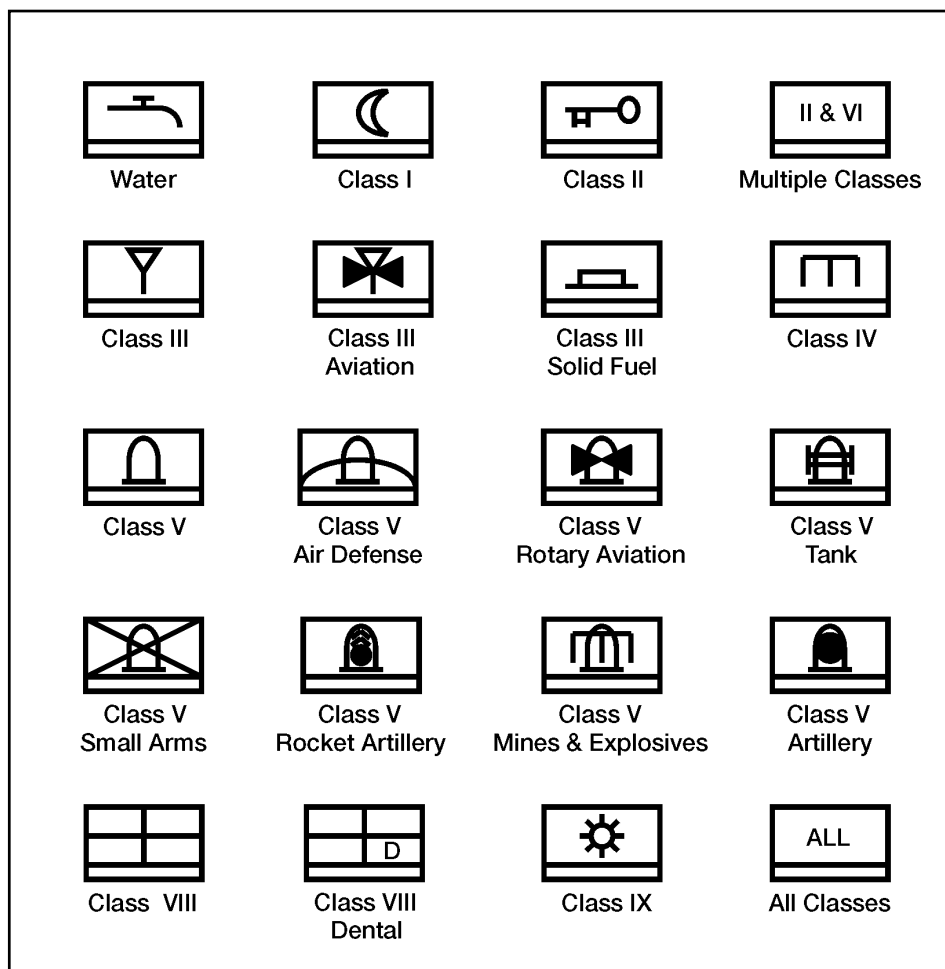

Figure B-9. Supply Sites

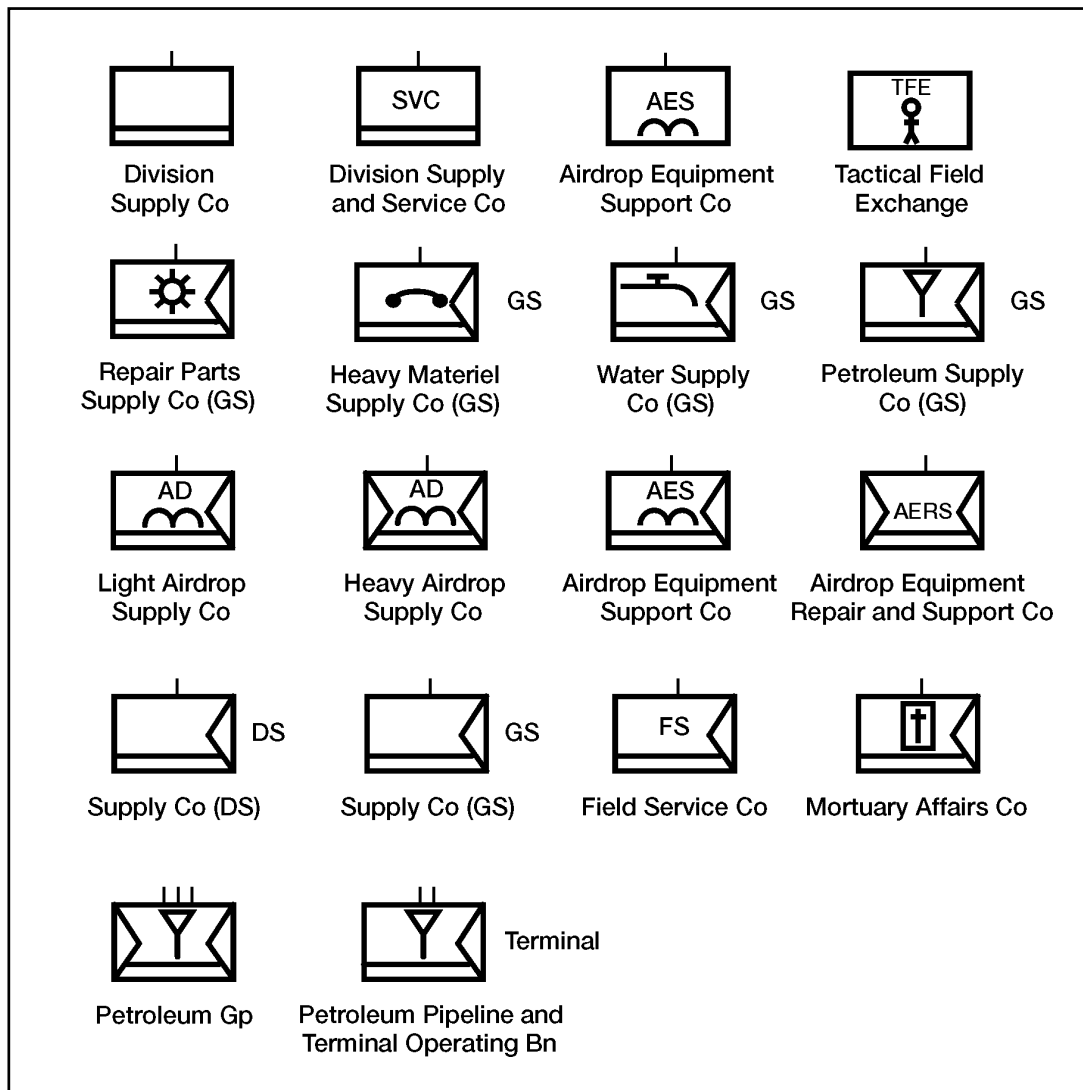

Figure B-10. Combat Service Support Units











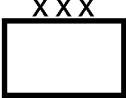

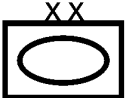
 <p>VII SUSA VII Corps, Seventh United States Army</p>		 <p>III MARFORPAC III Marine Expeditionary Forces, Marine Corps Forces, Pacific</p>	
 <p>2 III 2d Armored Division, III Corps</p>		 <p>5 I/EUSA 5th Infantry Division (Mechanized), I Corps, Eighth United States Army</p>	
 <p>2 10 (US) 2d Brigade, 10th Mountain Division (shows it is a U.S. division)</p>		 <p>2 III 2d Marine Expeditionary Brigade, III Marine Expeditionary Forces</p>	
 <p>11 V 11th Armored Cavalry Regiment, V Corps</p>		 <p>4 2 2d Infantry Regiment, 2d Marine Division</p>	
 <p>3-319 3d Battalion, 319th Field Artillery</p>	 <p>2-31 2d Battalion, 31st Infantry (Armored Wheeled)</p>	 <p>25 19 TSC 25th Transportation Battalion, 19th Theater Support Command</p>	
 <p>B 1-187 B Company, 1st Battalion, 187th Infantry (Air Assault)</p>	 <p>C 2-9/2ID C Company, 2d Battalion, 9th Infantry, 2d Infantry Division</p>		 <p>A 66 A Company, 66th Military Intelligence Battalion</p>
 <p>1 B/421 1st Platoon, B Company, 421st Chemical Battalion</p>		 <p>4101 44/X Engineer Construction Supply Site for 4101st Engineer Construction Support Company, 44th Engineer Group, X Corps</p>	

Figure B-11. Unit Symbols with Labeling Fields

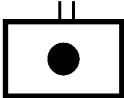
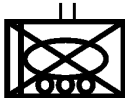
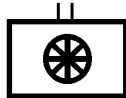

 <p>Six 5 ton trucks from B Co, 2d Engr Bn moving due east at 090 degrees.</p>	 <p>A Phoenix type UAV launch site from B Co, 301st MI Bn with a launch direction of 130 degrees.</p>
 <p>Six 4.2-inch medium mortars in tracked vehicles from HHC, 2d Bn, 31st Inf (Mech) at 50% of its ammunition supply.</p>	 <p>Six M-198 (155-mm) medium howitzers from A Btry, 2d Bn, 31st.</p>
 <p>Two Stinger air defense missiles from 1st section, 1st Plt, A Btry, 2d Bn, 7th ADA in a wheeled vehicle.</p>	 <p>Four M2A1 (Bradley) armored fighting vehicles from 3d Plt, A Co, 1st Bn, 87th Inf, 3d Bde with a "green" readiness rating moving at 180 degrees.</p>
 <p>Seven M1A2 (Abrams) tanks from E Trp, 2d Sqdn, 3d ACR.</p>	 <p>Three tracked multiple rocket launchers (MLRS) from A Btry, 3d Bn, 16th FA in a "HIDE" POSITION.</p>

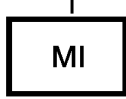
Figure B-12. Equipment Symbols with Labeling Fields

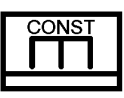



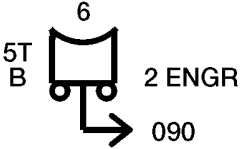
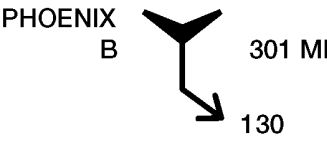
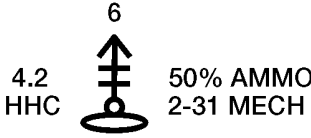
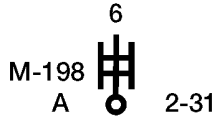
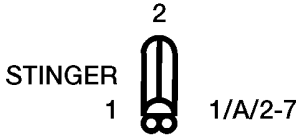
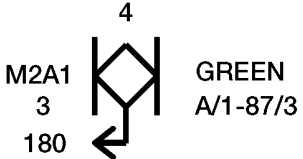
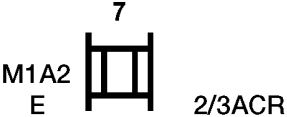

<p>SITE 12  STORAGE ASIAN OIL CORP</p> <p>Site 12, which is a storage site for the Asian Oil Corporation.</p>	<p>PLANT 7  FERTILIZER WORLD CHEM CO</p> <p>Plant 7, which produces fertilizer for the World Chemical Company.</p>
<p>BAY CITY  MARINE ENGINES WEST PAC</p> <p>Bay City production facility, which makes marine engines for Western Pacific.</p>	<p>TREATMENT  YELLOW CENTRAL CITY 10,000 KL/DAY</p> <p>Water treatment plant for Central City, which has a capacity of 10,000 kiloliters per day, but has a yellow readiness status.</p>
<p>RIVER CITY  GOV 150 BEDS</p> <p>River City Hospital, which is run by the government with a 150-bed capacity.</p>	<p>HITOWN  INTERMODAL INT'L CONTAINER LTD</p> <p>Intermodal transfer facility for Hitown for International Container Limited.</p>

Figure B-13. Installation Symbols with Labeling Fields



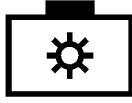

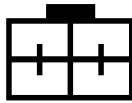
<p>240530ZJUN00  TERRORIST 2/A/503MP</p> <p>A terrorist was arrested by the 2d Sec, 2d Plt, A Co, 503 MP Bn at 0530Z on 24 Jun 00.</p>	<p>PS660480  UN</p> <p>Food for Peace under UN auspices is distributing food at grid PS660480.</p>
<p>UC190740  ICRC/RC</p> <p>BORDER</p> <p>The International Committee of the Red Cross/Red Crescent is operating refugee camp border at grid UC 190740.</p>	<p>032247ZJUL00  MAYOR</p> <p>CENTRAL CITY</p> <p>The Central City mayor was kidnapped at 2247Z on 03 July 00.</p>

Figure B-14. Stability Operations and Support Operations Symbols with Labeling Fields

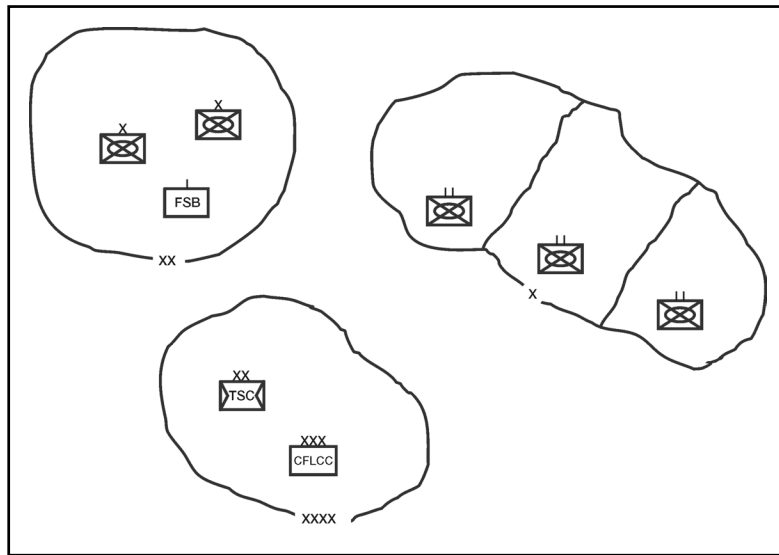

Figure C-2. Noncontiguous Areas of Operations

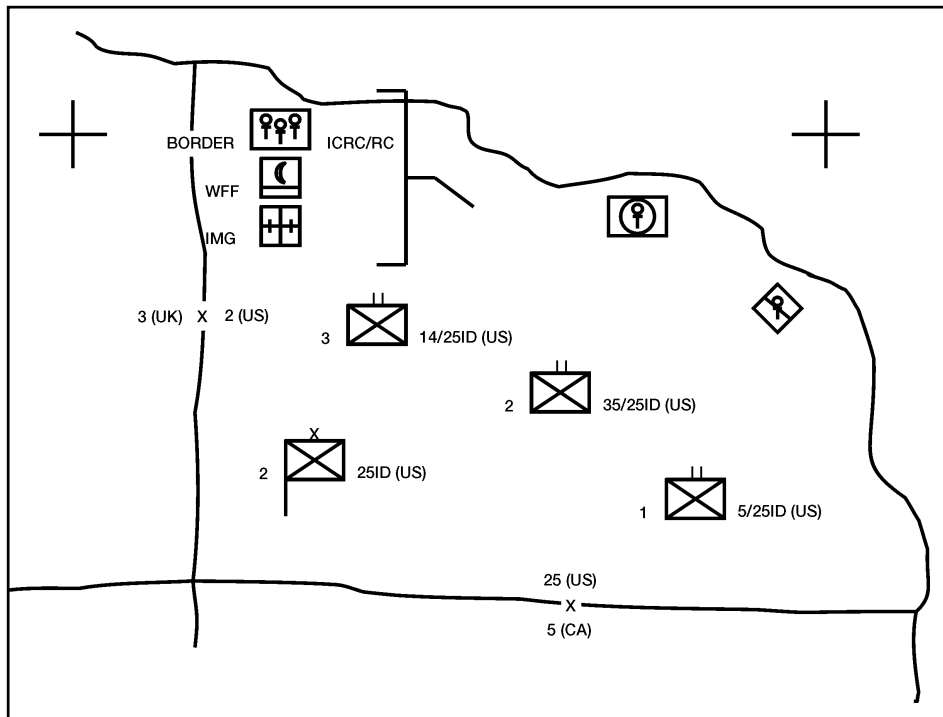

Figure C-3. Stability Operations and Support Operations

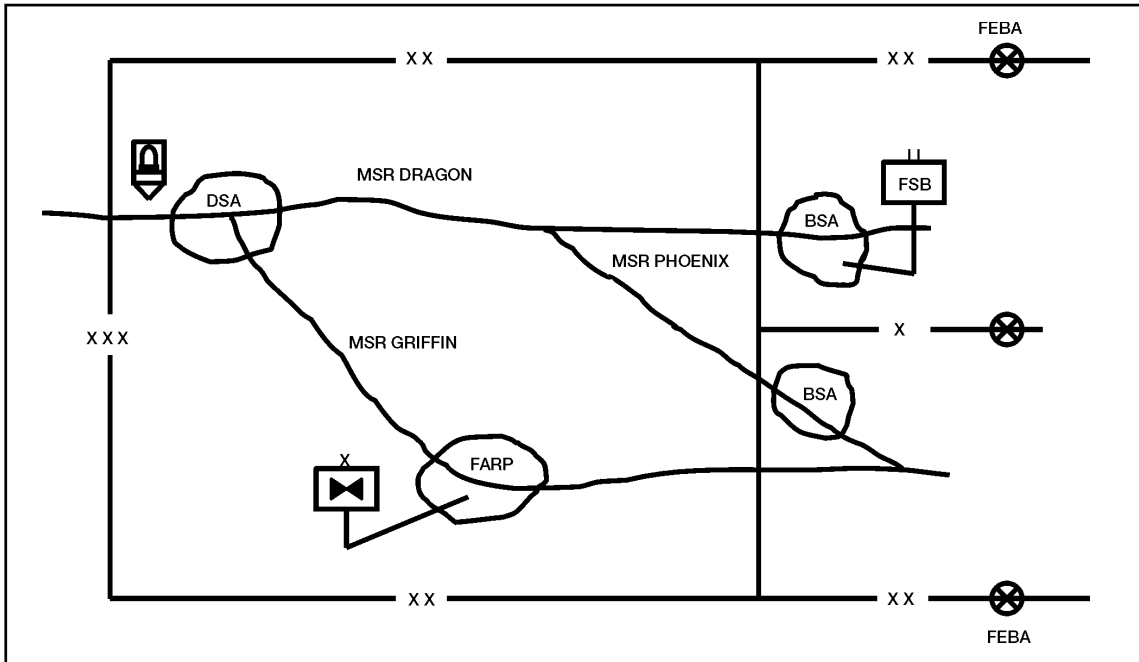

Figure C-4. Combat Service Support Operations

Appendix D

Military Decisionmaking Process Graphics

The tenets of Army operations are initiative, depth, agility, synchronization, and versatility. If commanders and staffs are to adhere to these tenets, they need information in a format that assists them to adapt quickly to the changing factors of METT-TC. The military symbols portrayed in chapters 4 through 9 are used to plot locations and directions of movement; however, the decisionmaker normally requires additional information for course of action sketches, synchronization matrixes, and maneuver sketches that are not readily available by studying a current situation map. The battlefield envisioned by our current doctrine requires rapid and frequent changes in task organization of units to seize or retain or take the initiative and move optimally task-organized forces to the critical point on the battlefield. Military decisionmaking process graphics are a tool for portraying the necessary information.

STATUS AND ASSESSMENT CHARTS

D-1. Commanders require two general categories of information when analyzing the situation map: the status of equipment and personnel, and the composition of the task-organized forces. Two common methods for displaying information and identifying status are the bar chart and the gumball chart. FM 6-0 provides information on the use of status and assessment charts.

BAR CHART

D-2. The bar chart is used to display quantities or percentages. Its major advantage is that it provides a simple method for comparing status indicators to each other and to a set, standard reference point. Bar charts also give the staff flexibility to display and relate various types and combinations of information for the commander. Figure D-1 shows an example of a bar chart.

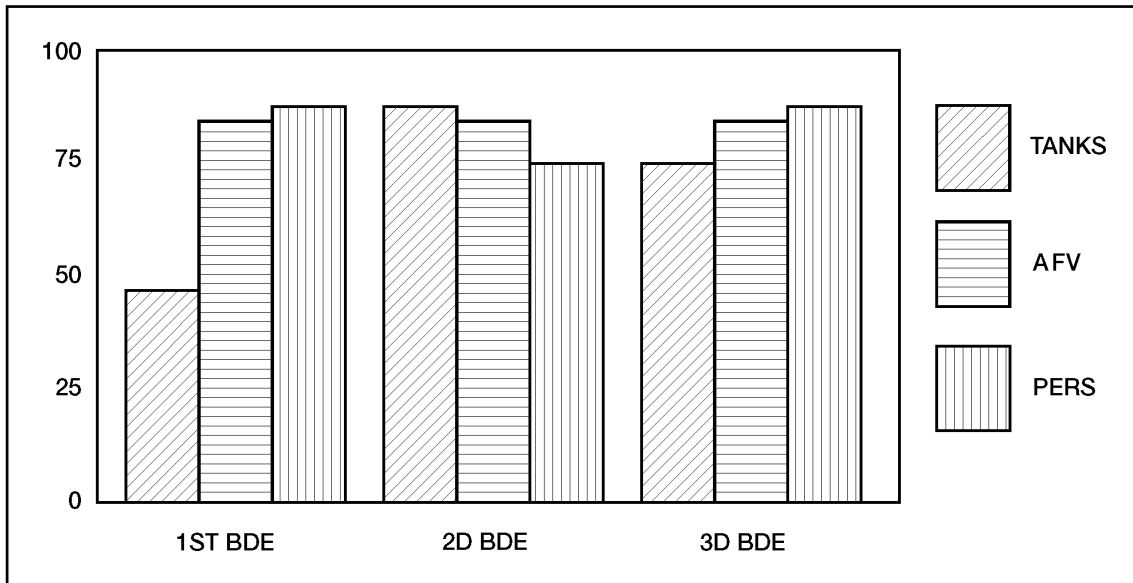

Figure D-1. Example of Bar Type Status Chart

GUMBALL CHART

D-3. The gumball chart provides a clear picture of the status of designated elements using a color code established in the unit standing operating procedures. The chart assists the commander to quickly assess the status of critical elements and assists the staff to focus on problem areas. Choose a color code consistent throughout all echelons of the command.

D-4. The following is a commonly used color code:

- **Green** indicates that the unit is at 85 percent or greater strength (combat capable).
- **Amber** indicates that the unit is at 70 to 84 percent strength (combat capable with minor deficiencies).
- **Red** indicates that the unit is at 50 to 69 percent strength (combat ineffective, unit has major losses or deficiencies).
- **Black** indicates that the unit is at less than 50 percent strength (requires reconstitution before next mission).
- **White** indicates not applicable or no information available.

D-5. See figure D-2 for an example of a gumball status chart.

UNIT	OVERALL	TANKS	AFV	HOW	ATKHEL	PER
1ST BDE	●	●	●	○	○	●
2D BDE	●	●	●	○	○	●
3D BDE	●	●	●	○	○	●
DIVARTY	●	○	○	●	○	●
AVN BDE	●	○	○	○	●	●

Figure D-2. Example of a Gumball Status Chart

COMBAT EFFECTIVENESS GRAPHICS

D-6. Situation reports (SITREPs) focus on the collection of information about the ability of subordinate units to perform their mission. Appropriate staff elements use various formats to report factors such as the status of fuel, ammunition, vehicle availability, and personnel. The commander, however, provides the net assessment of his unit's ability to perform the mission. This assessment can be expressed using decision graphics as shown in figure D-3.

D-7. The center column of figure D-3 visually depicts the overall combat rating of the unit, and the right column specifies the status of selected items of interest. The standing operating procedures (SOP) will specify the items of interest to be reported higher. The subordinate commander may add to this list for his internal reporting and tracking. The four items shown in the right column are ammunition, weapons, POL, and personnel.







Commander's Assessment of Unit's Ability to Perform Its Mission	Effectiveness Pie Charts	Selected Status Pie Chart <div style="display: flex; justify-content: space-around; align-items: center;"> <div style="border: 1px solid black; padding: 2px;">Personnel</div> <div style="border: 1px solid black; padding: 2px;">Ammunition</div> </div> <div style="display: flex; justify-content: center; align-items: center; margin: 5px 0;">  </div> <div style="display: flex; justify-content: space-around; align-items: center;"> <div style="border: 1px solid black; padding: 2px;">POL</div> <div style="border: 1px solid black; padding: 2px;">Weapons</div> </div>
No Problems in Any Area		
Some Problems in Personnel		
Major Problems in Weapons Systems		
Cannot Perform Mission—Personnel, Ammunition, and Weapons Problems		

Figure D-3. Example of Combat Effectiveness Chart

TASK ORGANIZATION COMPOSITION GRAPHICS

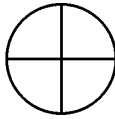
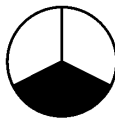
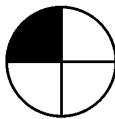
D-8. The resources available to the ground maneuver commander are provided as a detailed listing in the task organization portion of the operation order. This detailed listing may be later modified by fragmentary and warning orders. The headquarters and individual units of the task organization may be portrayed graphically by using multiple unit symbols as shown in chapter 5 of this manual. These symbols provide a rapid and easily understood means through situation maps, overlays, and annotated aerial photographs to express an operation plan, concept, or friendly or hostile (enemy) situation. However, they do not provide decisionmakers with a quick and easy method of portraying information relating to task organization composition.

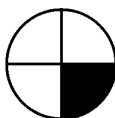
D-9. Figure D-4 shows a task force organized around the headquarters of the 2d Battalion, 2d Infantry Regiment (mechanized), of the 1st Brigade, 1st Infantry Division (mechanized) using a unit symbol. The task force unit symbol (figure D-4) shows the basic unit, but does not show how the unit is organized. While the overall combat effectiveness of the unit can be displayed using

the “K” field, more detailed information on combat effectiveness can not be displayed. Although this data may be available through other charts, reports, and briefings, its impact can be lost if the decisionmaker is required to go to different documents.

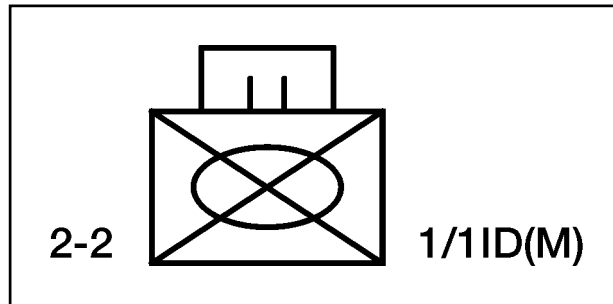

Figure D-4. Unit Symbol for Task Force 2-2

D-10. Using the task organization branch or function symbols, figure D-5 shows TF 2-2 as a task organization composition graphic. It provides the details of how the task force is organized. Table D-1 shows examples of task organization branch or function symbols for use in building decision graphics. (Task organization unit graphics are never displayed in conjunction with unit symbols as shown in figure D-4.) In figure D-5, Task Force 2-2 Mechanized Infantry is organized with two mechanized infantry companies, one armor company, one engineer company, and one reduced antitank company.

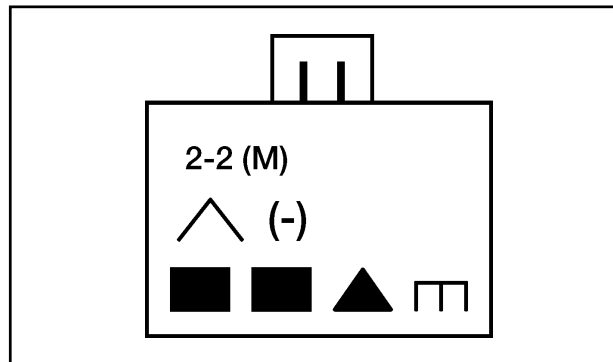

Figure D-5. Example of a Task Organization Composition Graphic

D-11. The task organization composition graphic is built using a rectangular frame. On the top and centered in the middle of the rectangular frame is the echelon graphic symbol and task force symbol (if required). Inside the frame on the top line is the unique designation of the organization being displayed. If any unit is not one echelon lower than the designated unit on line one, then the echelon indicator is used above the task organization unit graphic (see figure D-7 on page D-8.). For a unit that is reduced, reinforced, or reduced and reinforced, use the appropriate symbol (see figure D-5).

Table D-1. Task Organization Unit Symbols

















Branch or Function	Task Organization Composition Symbols
Air Defense	
Armor	
Armored Cavalry	
Antitank	
Attack Helicopters	
Air Cavalry	
Assault/Lift Helicopters	
Engineer	
Field Artillery	
Reconnaissance/Scout	

Table D-1. Task Organization Unit Symbols

Branch or Function	Task Organization Composition Symbols
Infantry	
Air Assault Infantry	
Airborne Infantry	
Light Infantry	
Mechanized Infantry	
Medium Infantry	
Mountain Infantry	

DECISION GRAPHICS

D-12. Combat effectiveness graphics and task organization composition graphics can be combined to form decision graphics. Examples of decision graphics at the company/team, battalion/task force, and brigade levels are displayed in figure D-6, page D-8; figure D-7, page D-8, and figure D-8, page D-9. Using the color coding system for gumball charts as described in paragraphs D-3 and D-4, green, amber, red, or black can be used for the fill colors or outlines of the task organization unit graphics to show the combat effectiveness status of the subordinate units. Decision graphics can be combined with mission graphics (appendix A) for use in course of action sketches, synchronization matrixes, and maneuver sketches. See figure A-1, page A-7,

for an example of decision graphics and tactical mission graphics used together. FM 101-5 provides information on the use of decision graphics and tactical mission graphics.

D-13. In figure D-6, Team A, 1st Battalion, 72d Armor is organized with two mechanized infantry platoons and one armor platoon. It has “some problems” performing its mission because of weapons systems.

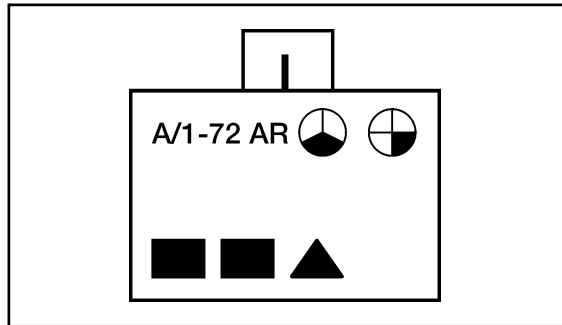

Figure D-6. Example of a Company Team Decision Graphic

D-14. In figure D-7, Task Force 1-72 Armor is organized with two mechanized infantry companies, two armor companies, and an air defense platoon. It has “major problems” performing its mission because of personnel and weapons systems.

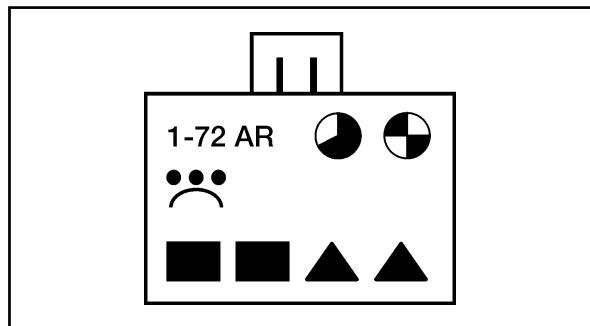

Figure D-7. Example of a Task Force Decision Graphic

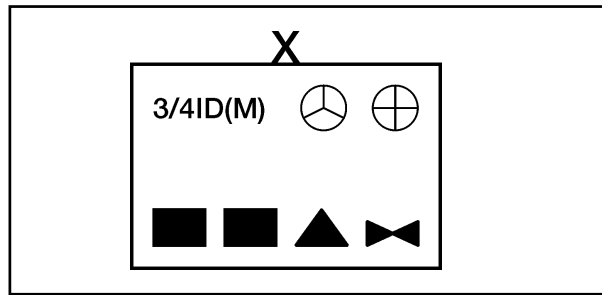

Figure D-8. Example of a Brigade Decision Graphic

Bibliography

SOURCES USED

JOINT PUBLICATIONS

JP 1-02. *Department of Defense Dictionary of Military and Associated Terms*. 12 April 2001 (as amended through 05 June 2003).

NATO PUBLICATIONS

AAP-15. *NATO Glossary of Abbreviations Used in NATO Documents and Publications*. December 2003.

STANAG 1059. *National Distinguishing Letters for Use by NATO Armed Forces*. 6 December 1988.

STANAG 2019/APP-6(A). *Military Symbols for Land Based Systems*. October 1998.

STANAG 2022. *Intelligence Reports*. 29 September 1988.

STANAG 2961. *Classes of Supply of NATO Land Forces*. 11 December 1984.

STANAG 3680/AAP-6 (2003). *NATO Glossary of Terms and Definitions (English and French)*. December 2002.

QUADRIPARTITE AGREEMENTS

QSTAG 509. *Military Symbols*. 5 March 1979.

QSTAG 511. *Intelligence Reports*. 5 April 1979.

ARMY PUBLICATIONS

AR 600-82FM 1 (FM 100-1). *The Army*. 14 June 2001.

FM 1-05 (FM 16-1). *Religious Support*. 18 April 2003.

FM 1-112. *Attack Helicopter Operations*. 02 April 1997. (Will be revised as FM 3-04.112.)

FM 3-0 (FM 100-5). *Operations*. 14 June 2001.

FM 3-04.111 (FM 1-111) *Aviation Brigades*. 21 August 2003.

FM 3-05.20 (FM 31-20). *Special Forces Operations*. 26 June 2001.

FM 3-05.30 (FM 33-1). *Psychological Operations*. 19 June 2000.

FM 3-05.201. *Special Forces Unconventional Warfare Operations*. 30 April 2003.

FM 3-06 (FM 90-10). *Urban Operations*. 01 June 2003.

FM 3-07 (FMs 90-29, 100-19, 100-20, 100-23). *Stability Operations and Support Operations*. 20 February 2003.

FM 3-3. *Chemical and Biological Contamination Avoidance*. 16 November 1992.

FM 3-3-1. *Nuclear Contamination Avoidance*. 09 September 1994.

FM 3-5. *NBC Decontamination*. 28 July 2000, change 1, 31 January 2002. (Will be revised as FM 3-11.5.)

- FM 3-6. *Field Behavior of NBC Agents (Including Smoke and Incendiaries)*. 03 November 1986.
- FM 3-7. *NBC Field Handbook*. 29 September 1994. (Will be revised as FM 3-11.7.)
- FM 3-9. *Potential Military Biological/Chemical Agents and Compounds*. 12 December 1990.
- FM 3-11 (FM 3-100). *Multiservice Tactics, Techniques, and Procedures for Nuclear, Biological, and Chemical Defense Operations*. 10 March 2003.
- FM 3-11.4 (FM 3-4). *Multiservice Tactics, Techniques, and Procedures for Nuclear, Biological, and Chemical (NBC) Protection*. 02 June 2003.
- FM 3-11.21 (FM 3-21). *Multiservice Tactics, Techniques, and Procedures for Nuclear, Biological, and Chemical Aspects of Consequence Management*. 12 December 2001.
- FM 3-13 (FM 100-6). *Information Operations Doctrine: Tactics, Techniques, and Procedures*. 28 November 2003.
- FM 3-19. *NBC Reconnaissance*. 19 November 1993. (Will be revised as FM 3-11.19.)
- FM 3-19.1 (FM 19-1). *Military Police Operations*. 22 March 2001, change 1, 31 January 2002.
- FM 3-19.4 (FM 19-4). *Military Police Leaders' Handbook*. 04 March 2002, change 1, 02 August 2002.
- FM 3-19.30 (FM 19-30). *Physical Security*. 08 January 2001.
- FM 3-19.40 (FM 19-40). *Military Police Internment/Resettlement Operations*. 01 August 2001.
- FM 3-20.12 (FMs 17-12-1-1 and 17-12-1-2). *Tank Gunnery (Abrams)*. 01 October 2001.
- FM 3-20.15 (FM 17-15). *Tank Platoon*. 01 November 2001.
- FM 3-20.96. *Cavalry Squadron (RSTA)*. 23 December 2002.
- FM 3-21.91 (FM 7-91). *Tactical Employment of Antiarmor Platoons and Companies*. 26 November 2002.
- FM 3-22.1 (FM 23-1). *Bradley Gunnery*. 28 November 2003.
- FM 3-22.9 (FM 23-9). *Rifle Marksmanship M16A1, M16A2/3, M16A4 and M4 Carbine*. 24 April 2003.
- FM 3-22.68 (FM 23-14). *Crew-Served Machine Guns, 5.56-mm and 7.62-mm*. 31 January 2003.
- FM 3-25.26 (FM 21-26). *Map Reading and Land Navigation*. 20 July 2001.
- FM 3-34.2 (FM 90-13-1). *Combined Arms Breaching Operations*. 31 August 2000, change 3, 11 October 2002.
- FM 3-34.230 (FM 5-105). *Topographic Operations*. 03 August 2000.
- FM 3-34.331 (FM 5-232). *Topographic Surveying*. 16 January 2001.
- FM 3-50. *Smoke Operations*. 04 December 1990, change 1, 11 September 1996. (Will be revised as FM 3-11.50.)
- FM 3-52 (FM 100-103). *Army Airspace Command and Control in a Combat Zone*. 01 August 2002.
- FM 3-54.10 (FM 3-97.18). *Brevity: Multiservice Brevity Codes*. 5 June 2003.
- FM 3-90. *Tactics*. 04 July 2001.
- FM 3-90.1 (FM 71-1). *Tank and Mechanized Infantry Company Team*. 09 December 2002.

- FM 3-100.4. *Environmental Considerations in Military Operations*. 15 June 2000, change 1, 11 May 2001. (Will be revised as FM 4-04.4.)
- FM 3-100.21 (FM 100-21). *Contractors on the Battlefield*. 03 January 2003.
- FM 4-0 (FM 100-10). *Combat Service Support*. 29 August 2003.
- FM 4-01.30 (FM 55-10). *Movement Control*. 01 September 2003.
- FM 4-02 (FM 8-10). *Force Health Protection in a Global Environment*. 13 February 2003.
- FM 4-02.6 (FM 8-10-1). *The Medical Company. Tactics, Techniques, and Procedures*. 01 August 2002.
- FM 4-02.7 (FM 8-10-7). *Health Service Support in a Nuclear, Biological, and Chemical Environment. Tactics, Techniques, and Procedures*. 01 October 2002.
- FM 4-02.17. *Preventive Medicine Service*. 28 August 2000.
- FM 4-02.24 (8-10-24). *Area Support Medical Battalion Tactics, Techniques, and Procedures*. 28 August 2000.
- FM 4-20.41 (FM 10-500-1). *Aerial Delivery Distribution in the Theater of Operations*. 29 August 2003.
- FM 4-30.3 (FM 9-43-1). *Maintenance Operations and Procedures*. 01 September 2000.
- FM 4-30.13 (FMs 9-13 and 9-38). *Ammunition Handbook: Tactics, Techniques, and Procedures for Munitions Handlers*. 01 March 2001.
- FM 5-34. *Engineer Field Data*. 30 August 1999, change 3, 10 April 2003. (Will be revised as FM 3-34.310.)
- FM 5-100. *Engineer Operations*. 27 February 1996. (Will be revised as FM 3-34.)
- FM 5-100-15. *Corps Engineer Operations*. 06 June 1995. (Will be revised as FM 3-34.226.)
- FM 5-103. *Survivability*. 10 June 1985. (Will be revised as FM 3-34.112.)
- FM 5-250. *Explosives and Demolitions*. 30 July 1998, change 1, 30 June 1999. (Will be revised as FM 3-34.214.)
- FM-5-430-00-1. *Planning and Design of Roads, Airfields, and Heliports in the Theater of Operations—Airfield and Heliport Design*. 26 August 1994. (Will be revised as FM 3-34.461.)
- FM 5-430-00-2. *Planning and Design of Roads, Airfields, and Heliports in the Theater of Operations—Airfield and Heliport Design*. 29 September 1994. (Will be revised as FM 3-34.462.)
- FM 6-0 (FMs 100-34 and 101-5). *Mission Command: Command and Control of Army Forces*. 11 August 2003.
- FM 6-2. *Tactics, Techniques, and Procedures for Field Artillery Survey*. 23 September 1993, change 1, 16 October 1996. (Will be revised as FM 3-09.2.)
- FM 6-20. *Fire Support in the Airland Battle*. 17 May 1988. (Will be revised as FM 3-09.)
- FM 6-20-10. *Tactics, Techniques, and Procedures for the Targeting Process*. 08 May 1996. (Will be revised as FM 3-60.)
- FM 6-20-20. *Tactics, Techniques, and Procedures for Fire Support at Battalion Task Force and Below*. 27 December 1991.
- FM 6-20-30. *Tactics, Techniques, and Procedures for Fire Support for Corps and Division Operations*. 18 October 1989. (Will be revised as FM 3-09.5.)
- FM 6-20-40. *Tactics, Techniques, and Procedures for Fire Support for Brigade Operations (Heavy)*. 05 January 1990. (Will be revised as FM 3-09.4.)

- FM 6-22.5 (FM 22-9). *Combat Stress*. 23 June 2000.
- FM 6-30. *Tactics, Techniques, and Procedures for Observed Fire*. 16 July 1991. (Will be revised as FM 3-09.3.)
- FM 6-40. *Tactics, Techniques, and Procedures for Field Artillery Manual Cannon Gunnery*. 23 April 1996, change 1, 01 October 1999. (Will be revised as FM 3-09.40.)
- FM 6-50. *Tactics, Techniques, and Procedures for the Field Artillery Cannon Battery*. 23 December 1996. (Will be revised as FM 3-09.50.)
- FM 7-0 (FM 25-100). *Training the Force*. 22 October 2002.
- FM 7-7. *The Mechanized Infantry Platoon and Squad (APC)*. 15 March 1985. (Will be revised as FM 3-21.7.)
- FM 7-8. *Infantry Rifle Platoon and Squad*. 22 April 1992, change 1, 01 March 2001. (Will be revised as FM 3-21.8.)
- FM 7-10. *The Infantry Rifle Company*. 14 Dec 1990, change 1, 31 October 2000. (Will be revised as FM 3-21.10.)
- FM 7-15. *Army Universal Task List*. 31 August 2003.
- FM 7-20. *The Infantry Battalion*. 06 April 1992, change 1, 29 December 2000. (Will be revised as FM 3-21.20.)
- FM 7-30. *The Infantry Brigade*. 03 October 1995, change 1, 31 October 2000. (Will be revised as FM 3-21.30.)
- FM 8-10-6. *Medical Evacuation in a Theater of Operations. Tactics, Techniques, and Procedures*. 14 April 2000. (Will be revised as FM 4-02.2.)
- FM 8-51. *Combat Stress Control in a Theater of Operations. Tactics, Techniques, and Procedures*. 29 September 1994, change 1, 30 January 1998. (Will be revised as FM 4-02.51.)
- FM 8-55. *Planning for Health Service Support*. 09 September 1994. (Will be revised as FM 4-02.55.)
- FM 8-284. *Treatment of Biological Warfare Agent Casualties*. 17 July 2000, change 1, 8 July 2002. (Will be revised as FM 4-02.284.)
- FM 9-6. *Munitions Support in the Theater of Operations*. 20 March 1998. Will be revised as FM 4-30.1.)
- FM 10-1. *Quartermaster Principles*. 11 August 1994. (Will be revised as FM 4-20.)
- FM 10-15. *Basic Doctrine Manual for Supply and Storage*. 12 December 1990, change 1, 30 September 1993. (Will be revised as FM 4-20.06.)
- FM 10-27. *General Supply in Theaters of Operations*. 20 April 1993. (Will be revised as FM 4-20.1.)
- FM 10-64. *Mortuary Affairs Operations*. 16 February 1999. (Will be revised as FM 4-20.64.)
- FM 10-67. *Petroleum Supply in Theaters of Operations*. 18 February 1983, change 1, 10 October 1985. (Will be revised as FM 4-03.)
- FM 11-32. *Combat Net Radio Operations*. 15 October 1990.
- FM 11-43. *Signal Leader's Guide*. 12 June 1995. (Will be revised as FM 6-02.43.)
- FM 20-3. *Camouflage, Concealment, and Decoys*. 30 August 1999. (Will be revised as FM 3-58.1.)

- FM 20-32. *Mine/Countermine Operations*. 29 May 1998, change 3, 1 October 2002. (Will be revised as FM 3-34.32.)
- FM 21-16. *Unexploded Ordnance (UXO) Procedures*. 30 August 1994. (Will be revised as FM 4-30.11.)
- FM 22-100. *Army Leadership*. 31 August 1999. (Will be revised as FM 6-22.)
- FM 24-1. *Signal Support in the AirLand Battle*. 15 October 1990. (Will be revised as FM 6-02.)
- FM 24-19. *Radio Operator's Handbook*. 24 May 1991.
- FM 27-10. *The Law of Land Warfare*. 18 July 1956, change 1, 15 July 1976. (Will be revised as FM 1-04.10.)
- FM 31-20-5. *Special Reconnaissance Tactics, Techniques, and Procedures for Special Forces*. 23 March 1993.
- FM 33-1-1. *Psychological Operations Techniques and Procedures*. 05 May 1994. (Will be revised as FM 3-05.301.)
- FM 34-1. *Intelligence and Electronic Warfare Operations*. 27 September 1994. (Will be revised as FM 2-0.)
- FM 34-2. *Collection Management and Synchronization Planning*. 08 March 1994. (Will be revised as FM 2-33.3.)
- FM 34-3. *Intelligence Analysis*. 15 March 1990. (Will be revised as FM 2-33.4.)
- FM 34-45. *Tactics, Techniques, and Procedures for Electronic Attack*. 09 June 2000. (Will be revised as FM 2-00.45.)
- FM 34-52. *Intelligence Interrogation*. 28 September 1992. (Will be revised as FM 2-22.3.)
- FM 34-60. *Counterintelligence*. 03 October 1995. (Will be revised as FM 2-01.2.)
- FM 34-130. *Intelligence Preparation of the Battlefield*. 08 July 1994. (Will be revised as FM 2-01.3.)
- FM 41-10. *Civil Affairs Operations*. 14 February 2000. (Will be revised as FM 3-05.40.)
- FM 44-100. *US Army Air and Missile Defense Operations*. 15 June 2000. (Will be revised as FM 3-01.)
- FM 46-1. *Public Affairs Operations*. 30 May 1997.
- FM 55-1. *Transportation Operations*. 03 October 1995. (Will be revised as FM 4-01.)
- FM 55-17. *Cargo Specialists' Handbook*. 16 February 1999. (Will be revised as FM 4-01.5.)
- FM 55-20. *Rail Transport in a Theater of Operations*. 01 June 2000. (Will be revised as 4-01.41.)
- FM 55-30. *Army Motor Transport Units and Operations*. 27 June 1997. (Will be revised as FM 4-01.40.)
- FM 55-50. *Army Water Transport Operations*. 30 September 1993. (Will be revised as FM 4-01.50.)
- FM 55-60. *Army Terminal Operations*. 15 April 1996. (Will be revised as FM 4-01.50.)
- FM 63-2. *Division Support Command, Armored, Infantry, and Mechanized Infantry Divisions*. 20 May 1991. (Will be revised as FM 4-93.2.)
- FM 71-123. *Tactics and Techniques for Combined Arms Heavy Forces: Armored Brigade, Battalion Task Force, and Company Team*. 30 September 1992. (Will be revised as FM 3-90.123.)

- FM 90-4. *Air Assault Operations*. 16 March 1987. (Will be revised as FM 3-18.12.)
- FM 90-7. *Combined Arms Obstacle Integration*. 29 September 1994, change 1, 10 April 2003. (Will be revised as FM 3-34.1.)
- FM 90-13. *River Crossing Operations*. 26 January 1998. (Will be revised as FM 3-34.13.)
- FM 90-26. *Airborne Operations*. 18 December 1990. (Will be revised as FM 3-18.11.)
- FM 100-7. *Decisive Force: The Army in Theater Operations*. 31 May 1995. (Will be revised as FM 3-93.)
- FM 100-8. *The Army in Multinational Operations*. 24 November 1997. (Will be revised as FM 3-16.)
- FM 100-9. *Reconstitution*. 13 January 1992. (Will be revised as FM 4-100.9.)
- FM 100-10-1. *Theater Distribution*. 01 October 1999. (Will be revised as FM 4-01.4.)
- FM 100-12. *Army Theater Missile Defense Operations*. 31 March 2000. (Will be revised as FM 3-01.12.)
- FM 100-13. *Battlefield Coordination Detachment (BCD)*. 05 September 1996. (Will be revised as FM 3-09.13.)
- FM 100-14. *Risk Management*. 23 April 1998. (Will be revised as FM 5-19.)
- FM 100-17. *Mobilization, Deployment, Redeployment, Demobilization*. 28 October 1992. (Will be revised as FM 3-35.)
- FM 100-17-2. *Army Pre-Positioned Land*. 16 February 1999. (Will be revised as FM 3-35.2.)
- FM 100-17-3. *Reception, Staging, Onward Movement, and Integration*. 17 March 1999. (Will be revised as FM 4-01.8.)
- FM 100-18. *Space Support to Army Operations*. 20 July 1995. (Will be revised as FM 3-14.)
- FM 100-25. *Doctrine for Army Special Operations Forces*. 01 August 1999. (Will be revised as FM 3-05.)
- FM 100-30. *Nuclear Operations*. 29 October 1996. (Will be revised as FM 3-12.)
- FM 101-5. *Staff Organization and Operations*. 31 May 1997. (Will be revised as FM 5-0.)
- FM 101-5-2. *US Army Report and Message Formats*. 29 June 1999. (Will be revised as FM 6-99.2.)

MARINE CORPS PUBLICATIONS

- MCRP 5-12C. *Marine Corps Supplement to the Department of Defense Dictionary of Military and Associated Terms*. 23 July 1998.
- MCWP 2-15.4. *Imagery Intelligence*. 6 September 2002.

DOCUMENTS NEEDED (NONE)

READINGS RECOMMENDED (NONE)

Index of Symbols

A
activities
arrest, 9-6
arson, 9-6
assassination, 9-6
bomb/bombing, 9-6
booby trap, 9-6
computer network attack (CNA), 9-6
demonstration, 9-7
drive-by shooting, 9-7
electronic warfare intercept, 9-7
execution, 9-6
extortion, 9-7
fire, 9-6
foraging/searching, 9-7
graffitti, 9-7
hijacking, 9-7
hijacking merchant, 9-9
hijacking, air, 9-7
hijacking, airplane, 9-7
hijacking, helicopter, 9-7
hijacking, leisure craft, 9-9
hijacking, sea surface, 9-9
hijacking, vehicle, 9-7
kidnapping, 9-9
murder, 9-6
patrolling, 9-9
poisoning, 9-9
psychological operations, 9-9
psychological operations, broadcast, aerial fixed wing station, 9-9
psychological operations, distribution center, 9-9
psychological operations, face-to-face, 9-9
psychological operations, loudspeaker broadcast, 9-9
psychological operations, loudspeaker broadcast, helicopter rotary wing mounted, 9-11
psychological operations, loudspeaker broadcast, wheeled vehicle mounted, 9-11
psychological operations, printing service, 9-11
psychological operations, radio broadcast, 9-11

psychological operations, target audience location, 9-11
psychological operations, television broadcast, 9-11
psychological operations, written, 9-11
recruitment, 9-11
recruitment, coerced/impressed, 9-13
recruitment, willing, 9-11
riot, 9-13
sniping, 9-13
air assault, 5-45
organic lift, 5-45
organic lift (NATO), 5-45
air defense, 5-7
composite (gun and missile), 5-7
gun, 5-7
high-to-medium altitude missile defense (HIMAD), 5-7
missile, 5-7
targeting unit, 5-7
theater missile defense (TMD), 5-7
airborne, 5-45
alliance commands
Supreme Allied Command Atlantic (SACLANT), 5-59
Supreme Headquarters Allied Powers Europe (SHAPE), 5-59
amphibious, 5-45
antiarmor/antitank, 5-7
arctic, 5-45
areas
airfield zone, 7-47
airspace coordination (ACA), 7-40
assault position, 7-34
assembly (AA), 7-17
assembly area occupied by multiple units, 7-17
biologically contaminated, 7-64
bomb, 7-40
brigade support (BSA), 7-76
chemically contaminated area, 7-64
combat outpost), 7-27
decoy mined, 7-24
detainee holding, 7-76

division support (DSA), 7-77
drop zone (DZ), 7-18
enemy known or confirmed, 7-16
enemy known or confirmed strong point), 7-27
enemy prisoner of war (EPW) holding, 7-76
enemy suspected, 7-17
engagement (EA), 7-19
engagement area (EA), 7-26
extraction zone (EZ), 7-18
fenced decoy mined, 7-24
fire support (FSA), 7-40
fortified, 7-19
forward area air defense engagement zone (FAADEZ), 7-21
forward arming and refuel point (FARP), 7-76
forward assembly (FAA), 7-17
forward observer (FO) position, 7-27
free fire (FFA), 7-40
friendly, 7-16
friendly planned or on order, 7-16
friendly strong point (SP), 7-26
high-altitude missile engagement zone (HIMEZ), 7-22
high-density airspace control zone (HIDACZ), 7-21
landing zone (LZ), 7-18
limited access, 7-60
low-altitude missile engagement zone (LOMEZ), 7-22
mined, 7-53
minimum safe distance (MSD) zone, 7-61
missile engagement zone (MEZ), 7-22
named area of interest (NAI), 7-38
NBC observation post (dismounted), 7-28
no-fire (NFA), 7-40

<p>observation outpost occupied by reconnaissance), 7-27 observation post (OP)/outpost), 7-27 occupied, 7-26 occupied assembly, 7-17 of operations (AO), 7-38 pickup zone (PZ), 7-18 planned, 7-26 position area for artillery (PAA), 7-41 prepared but not occupied, 7-26 principal direction of fire (PDF), 7-28 proposed or on order assembly, 7-17 radioactive, 7-64 regimental support (RSA), 7-77 restricted operations zone (ROZ), 7-21 restrictive fire (RFA), 7-41 search/reconnaissance, 7- 18 sensor outpost/listening post, 7-28 targeted area of interest (TAI), 7-38 unexploded ordnance, 7-55 weapons free zone (WFZ), 7-22 armies Eighth United States Army (EUSA), 5-57 Third United States Army (TUSA), 5-57 armor, 5-7 amphibious armor/armored/track, 5-7 amphibious recovery armor/armored/track, 5-9 armored/track/self- propelled, 5-7 track recovery, 5-9 wheeled armored, 5-9 wheeled armored amphibious, 5-9 wheeled armored amphibious recovery, 5-9 wheeled armored recovery, 5-9 armored (wheeled), 5-47 armored vehicles combat service support (CSS), 6-29</p>	<p>fighting command and control (C2), 6-30 infantry fighting, 6-29 personnel carrier, 6-29 personnel carrier recovery, 6-29 protected ground vehicle, 6- 26 tank, 6-26 tank heavy, 6-28 tank heavy recovery, 6-29 tank light, 6-28 tank light recovery, 6-28 tank medium, 6-28 tank medium recovery, 6-28 wheeled fighting, 6-30 Army Service Component Commands (ASCC) United States Army Central (ARCENT), 5-57 United States Army Europe (USAREUR), 5-57 United States Army Forces Command (FORSCOM), 5-57 United States Army Pacific (USARPAC), 5-57 United States Army South (USARSO), 5-57 assumed friend, 4-3 attack position by fire, 7-35 friendly, 7-34 friendly occupied, 7-35 friendly planned, proposed or on order, 7-35 objective, 7-35 support by fire position, 7- 35 automatic weapons rifle, 6-14 rifle/heavy machine gun, 6- 16 rifle/light machine gun, 6-16 aviation, 5-9 axis of advance enemy known or confirmed, 7-30 enemy templated or suspected, 7-30 feint, 7-24 friendly airborne, 7-29 friendly attack helicopter, 7- 29 friendly aviation, 7-29 friendly ground axis of decisive operations, 7-30</p>	<p>friendly ground axis of main attack, 7-30 friendly ground axis of shaping operations, 7-29 friendly ground axis of supporting attack, 7-29 friendly ground axis on order with date and time effective, 7-30 B band. See multifunctional combat service support bicycle equipped, 5-46 boundaries enemy known, 7-13 enemy suspected, 7-13 forward, 7-14 friendly planned or on order, 7-13 friendly present, 7-13 lateral, 7-13 rear, 7-14 C cavalry armored, 5-22 combat, 5-7 combat service support (CSS), 5-34 combat support unit, 5-25 combatant commands United States Central Command (CENTCOM), 5-59 United States European Command (EUCOM), 5- 59 United States Joint Forces Command (JFCOM), 5- 59 United States Northern Command (NORTHCOM), 5-59 United States Pacific Command (PACOM), 5- 59 United States Southern Command (SOUTHCOM), 5-59 composite (rotary wing and fixed wing), 5-11 convoys halted, 7-75 moving, 7-74 corps level multifunctional combat service support corps support battalion (CSB), 5-66</p>
---	---	---

Corps Support Command (COSCOM), 5-64
 corps support group (forward) (CSG(F)), 5-64
 corps support group (rear) (CSG(R)), 5-64
 force service support group (FSSG), 5-66
 crossing site
 assault area, 7-58
 bridge or gap, 7-58
 ferry, 7-58
 ford difficult, 7-59
 ford easy, 7-59
 lane, 7-59
 raft, 7-59

D

decoys/feints
 axis of advance for a feint, 7-24
 decoy mined area, 7-24
 direction of attack for a feint, 7-24
 dummy, 7-24
 fenced decoy mined area, 7-24
 phony minefield, 7-25
 direction of attack
 enemy aviation known or confirmed, 7-31
 enemy aviation templated or suspected, 7-31
 enemy ground known or confirmed, 7-32
 enemy ground templated or suspected, 7-32
 final coordination line, 7-33
 friendly attack planned or on order, 7-32
 friendly aviation, 7-30
 friendly aviation planned or on order, 7-31
 friendly decisive operations, 7-32
 friendly main attack, 7-32
 friendly shaping operations, 7-31
 friendly supporting attack, 7-31
 infiltration lane, 7-33
 limit of advance (LOA), 7-33
 line of departure (LD), 7-33
 line of departure/line of contact (LD/LC), 7-34
 probable line of deployment (PLD), 7-34

division level and below
 multifunctional combat service support
 division aviation support battalion (DASB), 5-66
 division support command (DISCOM), 5-66
 forward support battalion (FSB), 5-66
 main support battalion (MSB), 5-66

E

earthwork, small trench, or fortification, 7-60
 echelons
 army, 5-54
 army group, 5-54
 battalion/squadron, 5-54
 brigade, 5-54
 company/battery/troop, 5-54
 corps, 5-54
 division, 5-54
 platoon/detachment, 5-54
 regiment/group, 5-54
 region, 5-54
 section, 5-54
 squad, 5-54
 team/crew, 5-54
 electronic warfare, 5-28
 armored wheeled vehicle, 5-28
 corps support element, 5-30
 direction finding, 5-28
 intercept, 5-28
 jamming, 5-30
 theater/echelons above
 corps support element, 5-30
 encirclement
 ambush, 7-36
 friendly forces, 7-36
 hostile forces, 7-36
 engineer, 5-15
 bridging, 5-15
 combat, 5-15
 construction, 5-15
 diving, 5-15
 drilling, 5-17
 naval, 5-17
 topographic, 5-17
 engineer vehicles, 6-32
 armored carrier mine laying, 6-34
 attack/armed helicopter, 6-39
 bridge, 6-32
 cargo helicopter, 6-39
 civilian, 6-37

construction, 6-34
 dozer, 6-35
 earthmover, 6-34
 mine clearing armored mounted, 6-35
 mine clearing trailer mounted, 6-35
 mine laying, 6-34
 radar, 6-37
 railcar, 6-35
 reconnaissance helicopter, 6-39
 sensor, 6-37
 sensor emplaced, 6-37
 train locomotive, 6-35
 truck mounted mine laying, 6-34
 utility helicopter, 6-37
 equipment, 6-8
 explosive ordnance disposal (EOD), 5-34

F

field artillery, 5-17
 finance. See multifunctional combat service support
 fixed wing, 5-9
 and rotary wing (composite), 5-11
 attack, 5-9
 reconnaissance (Scout), 5-9
 unmanned aerial vehicle, 5-13
 utility, 5-9
 fort, 7-60
 fortified line, 7-60
 foxhole, emplacement, or weapon site, 7-61
 friend, 4-3
 friendly aviation
 petroleum/gas/oil, 8-2
 friendly mechanized infantry unit, 5-2
 friendly person-to-person psychological operations, 9-2
 friendly petroleum/gas/oil, 8-2
 friendly psychological operations, 9-2
 friendly wheeled armored infantry battalion with gun systems, 5-3
 friendly wheeled armored infantry unit, 5-2
 friendly wheeled armored infantry unit with gun systems, 5-3

G

generic joint and multinational commands
 assault command post (ASLT), 5-62
 Base Defense Operations Center (BDOC), 5-62
 combat trains command post (CTCP), 5-62
 command group (CMD), 5-62
 forward command post (FWD), 5-62
 forward trains command post (FTCP), 5-62
 Joint Force Air Component Command (JFACC), 5-61
 Joint Force Land Component Command (JFLCC), 5-61
 Joint Force Maritime Component Command (JFMCC), 5-61
 Joint Force Special Operations Component Command (JFSOCC), 5-61
 Joint Task Force (JTF), 5-61
 main command post (MAIN), 5-62
 Multinational Joint Task Force (MNJTF), 5-61
 rear command post (REAR), 5-62
 tactical command post (TAC), 5-62
 Tactical Operations Center (TOC), 5-62
 grenade launcher, 6-16
 heavy, 6-18
 light, 6-16
 medium, 6-16
 gun system, 5-46
 gun systems, 6-22
 air defense gun, 6-22
 air defense gun heavy, 6-24
 air defense gun light, 6-22
 air defense gun medium, 6-22
 antitank gun, 6-24
 antitank gun heavy, 6-24
 antitank gun light, 6-24
 antitank gun medium, 6-24
 direct fire gun, 6-25
 direct fire gun heavy, 6-26
 direct fire gun heavy self-propelled, 6-26

direct fire gun light, 6-25
 direct fire gun light self-propelled, 6-25
 direct fire gun medium, 6-25
 direct fire gun medium self-propelled, 6-26
 gun recoilless, 6-25

H

heavy/high altitude, 5-46
 higher echelon support corps support element, 5-34
 theater/echelons above corps support element, 5-34
 high-to-medium altitude missile defense (HIMAD), 5-7
 horse, camel, or pack animal equipped, 5-46
 hostile, 4-3
 howitzer, 6-20
 friendly, 6-2
 friendly medium, 6-2
 friendly medium self-propelled, 6-2
 friendly medium self-propelled (M109A6/Paladin), 6-3
 heavy, 6-22
 heavy self-propelled, 6-22
 light, 6-20
 light self-propelled, 6-20
 medium, 6-21
 medium self-propelled, 6-21
 howitzer/gun, 5-17
 amphibious, 5-17
 self-propelled, 5-17

I

infantry, 5-13
 air assault, 5-15
 airborne, 5-13
 arctic, 5-15
 light, 5-13
 mechanized or armored, 5-15
 mechanized/armored with gun system (infantry fighting vehicle), 5-15
 motorized, 5-13
 mountain, 5-13
 naval, 5-15
 information operations, 5-34
 installation, 8-6
 aircraft, 8-6
 aircraft, civilian fixed wing, 8-6
 aircraft, military fixed wing, 8-6

aircraft, military fixed wing bomber (B), 8-6
 aircraft, military rotary wing, 8-6
 aircraft, unmanned aerial vehicle, 8-6
 airport/airbase, 8-6
 ammunition and explosives, 8-6
 atomic energy reactor, 8-7
 electric power, 8-7
 electric power hydroelectric, 8-7
 engineering equipment, 8-7
 engineering equipment bridge, 8-8
 government leadership, 8-8
 ground vehicle, 8-8
 howitzer, 8-8
 medical facility, 8-8
 medical facility, hospital, 8-8
 military base/facility, 8-9
 mine, 8-9
 missile systems, 8-9
 NBC decontamination, 8-9
 petroleum/gas/oil, 8-9
 police station, 8-9
 railyard/railroad station, 8-10
 seaport, 8-10
 ship yard, 8-10
 tank, 8-10
 telecommunications, 8-10
 telecommunications, radio, 8-10
 telecommunications, telephone, 8-10
 telecommunications, television, 8-10
 vehicle, 8-10
 vehicle maintenance, 8-10
 water services, 8-10
 internal security forces, 5-25
 aviation, 5-25
 railroad, 5-25
 riverine, 5-25

J

Joint Information Bureau. See multifunctional combat service support
 Judge Advocate General (JAG). See multifunctional combat service support

L

labor. See multifunctional combat service support
 landing support, 5-34

- law enforcement
 civilian, 5-30
 Criminal Investigation
 Division (CID), 5-30
 military police, 5-30
 security police (AIR), 5-30
 shore patrol, 5-30
 light/low altitude, 5-46
 lines
 air corridor, 7-20
 airhead/airhead line (AL), 7-37
 bridgehead line (BL), 7-37
 coordinated fire (CFL), 7-39
 dose rate contour, 7-67
 final coordination line, 7-33
 final protective line (FPL), 7-25
 fire support coordination (FSCL), 7-39
 fortified, 7-60
 forward edge of the battle area (FEBA), 7-25
 forward line of own troops (FLOT) enemy known or confirmed, 7-15
 forward line of own troops (FLOT) enemy suspected, 7-15
 forward line of own troops (FLOT) friendly planned or on order, 7-15
 forward line of own troops (FLOT) friendly present, 7-14
 halted convoy, 7-75
 handover, 7-16
 holding line (HL), 7-37
 light (LL), 7-47
 line of departure (LD), 7-33
 line of departure/line of contact (LD/LC), 7-34
 low-level transit route (LLTR), 7-21
 minimum risk route (MRR), 7-20
 moving convoy, 7-74
 of contact (LC), 7-15
 phase (PL), 7-16
 probable line of deployment (PLD), 7-34
 release line (RL), 7-37
 restrictive fire line (RFL), 7-39
 standard-use Army aircraft flight route (SAAFR), 7-20
 unmanned aerial vehicle (UAV), 7-21
 locations
 ammunition cache, 9-13
 black list, 9-13
 drug operation, 9-13
 food distribution, 9-13
 gray list, 9-13
 mass grave site, 9-13
 medical treatment facility, 9-14
 radio, 9-14
 radio station, 9-14
 supply cache, 9-14
 television station, 9-14
 white list, 9-13
- M**
- maintenance, 5-44
 electro-optical, 5-44
 heavy, 5-44
 missile ordnance, 5-44
 ordnance, 5-44
 recovery, 5-44
 mechanized, armored, or self-propelled (tracked), 5-47
 medical, 5-38
 dental, 5-38
 fixed wing evacuation, 5-38
 medical treatment facility, 5-38
 psychological, 5-38
 rotary wing evacuation, 5-38
 veterinary, 5-38
 medium/medium altitude, 5-46
 meteorological, 5-19
 military intelligence, 5-26
 aerial exploitation, 5-26
 counterintelligence, 5-26
 ground station module (GSM), 5-28
 ground surveillance radar, 5-28
 Joint Intelligence Center, 5-28
 meteorological (MET), 5-28
 operations (OPS), 5-28
 sensor, 5-28
 sensor control module (SCM), 5-28
 signals intelligence (SIGINT), 5-26
 tactical exploitation (TE), 5-28
 minefields
 antipersonnel, 7-52
 antipersonnel reinforced with scatterable mines
 with self-destruct date-time group, 7-53
 antitank, 7-52
 antitank with gap, 7-52
 completed, 7-52
 executed volcano antitank, 7-53
 mined area, 7-53
 phony, 7-25
 planned, 7-52
 scatterable (antitank) with self-destruct date-time group, 7-53
 scatterable with self-destruct date-time group, 7-52
 mines
 antipersonnel (AP), 7-51
 antipersonnel showing direction of effects, 7-51
 antitank (AT), 7-51
 antitank with anti-handling device, 7-51
 cluster, 7-51
 unspecified, 7-51
 wide area, 7-51
 missile launcher, 6-8
 air defense (AD) short range, 6-8
 air defense
 intermediate/medium range, 6-9
 air defense long range, 6-9
 air defense surface-to-air (SAM), 6-8
 air defense theater, 6-9
 antitank, 6-10
 antitank heavy, 6-11
 antitank light, 6-10
 antitank medium, 6-10
 surface-to-surface (SSM), 6-9
 surface-to-surface
 intermediate/medium range, 6-10
 surface-to-surface long range, 6-10
 surface-to-surface short range, 6-9
 mobile subscriber element (MSE). See signal
 mobility
 amphibious, 6-43
 barge, 6-43
 over-snow (prime mover), 6-43
 pack animals, 6-43
 railway, 6-42

sled, 6-43
 towed, 6-42
 tracked, 6-42
 wheeled (cross-country), 6-42
 wheeled (limited cross-country), 6-42
 wheeled and tracked, 6-42
 morale, welfare, recreation (MWR). See multifunctional combat service support
 mortar, 5-21, 6-18
 amphibious, 5-21
 heavy, 6-18
 light, 6-18
 medium, 6-18
 self-propelled/tracked, 5-21
 towed, 5-21
 mortuary/graves registry. See multifunctional combat service support
 motorized, 5-47
 mountain, 5-47
 multifunctional combat service support
 administrative, 5-34
 administrative corps support element, 5-36
 administrative theater/echelons above corps support element, 5-34
 band, 5-36
 broadcast public affairs detachment, 5-36
 finance, 5-36
 Joint Information Bureau (JIB), 5-36
 Judge Advocate General (JAG), 5-36
 labor, 5-38
 morale, welfare, recreation (MWR), 5-38
 mortuary/graves registry, 5-36
 personnel services (PS), 5-36
 postal, 5-36
 public affairs, 5-36
 religious support (chaplain), 5-36
 replacement holding unit (RHU), 5-38

N

naval, 5-47
 neutral, 4-3
 nonmilitary organizations
 civilian helicopter, 9-14

drug vehicle, 9-14
 known insurgent, black list vehicle, 9-14
 media, 9-14
 refugees, 9-14
 safe house, 9-14
 spy, 9-14
 nuclear, biological, chemical, 5-25
 biological, 5-26
 biological attack or release event, 7-63
 biologically contaminated area, 7-64
 chemical, 5-25
 chemical attack or release event, 7-63
 chemical reconnaissance, 5-26
 chemical smoke, 5-26
 chemical smoke and decontamination, 5-25
 chemical wheeled armored reconnaissance surveillance, 5-26
 chemically contaminated area, 7-64
 dose rate contour lines, 7-67
 enemy known ground zero, 7-62
 enemy templated, 7-62
 equipment and troops decontamination site/point (DCN-E/T), 7-66
 equipment decontamination site/point (DCN-E), 7-66
 fallout producing, 7-63
 friendly planned or on order, 7-62
 minimum safe distance (MSD) zone, 7-61
 motorized biological reconnaissance, 5-26
 nuclear, 5-26
 nuclear detonations, friendly ground zero, 7-61
 operational decontamination site/point (DCN-O), 7-66
 radioactive area, 7-64
 thorough decontamination site/point (DCN-T), 7-67
 troops decontamination site/point (DCN-T), 7-65

unspecified alternate decontamination site/point (DCN), 7-65
 unspecified decontamination site/point (DCN), 7-65
 nuclear, biological, chemical (NBC), 8-9

O

obstacle effects
 block, 7-54
 disrupt, 7-54
 fix, 7-54
 obstacle restricted area, 7-55
 obstacle-free area, 7-55
 turn, 7-54
 unexploded ordnance area, 7-55
 obstacles
 abatis, 7-48
 antitank ditch reinforced with antitank mines, 7-49
 antitank ditch under construction, 7-49
 antitank wall, 7-50
 belt, 7-48
 booby trap, 7-51
 bypass difficult, 7-57
 bypass easy, 7-57
 bypass impossible, 7-58
 completed antitank ditch, 7-48
 explosives, state of readiness 1, 7-55
 explosives, state of readiness 2, 7-56
 fixed and prefabricated antitank tetrahedrons, dragon's teeth, and other similar, 7-50
 high wire fence, 7-56
 line, 7-48
 low wire fence, 7-56
 moveable and prefabricated antitank tetrahedrons, dragon's teeth, and other similar, 7-50
 moveable antitank tetrahedrons, dragon's teeth, and other similar, 7-50
 planned, 7-55
 roadblock complete, 7-56
 trip wire, 7-56
 wire, double apron fence, 7-56
 wire, double fence, 7-56

wire, double strand
concertina, 7-57
wire, single fence, 7-56
wire, single strand
concertina, 7-57
wire, triple strand
concertina, 7-57
wire, unspecified, 7-56
zone, 7-48

P

pending, 4-3
personnel services (PS). *See*
multifunctional combat
service support
points
air control (ACP), 7-23
ambulance exchange
(AXP), 7-68
ammunition supply (ASP),
7-74
ammunition transfer point
(ATP), 7-74
cannibalization (CAN), 7-68
casualty collection (CCP),
7-68
checkpoint (CKP), 7-45
civilian collection (CIV), 7-
68
communications checkpoint
(CCP), 7-23
contact (CP), 7-44
coordination, 7-44
decision (DP), 7-45
detainee collection (DET),
7-69
downed aircrew pickup), 7-
23
enemy prisoner of war
collection (EPW), 7-69
engineer regulating point
(ERP), 7-60
equipment and troops
decontamination
site/point (DCN-E/T), 7-
66
equipment decontamination
site/point (DCN-E), 7-66
fire support station (FSS), 7-
39
forward arming and refuel
point (FARP), 7-76
general or unspecified, 7-45
linkup (LU), 7-45
logistics release (LRP), 7-69
maintenance collection
(MCP), 7-69
of interest, 7-19

operational
decontamination
site/point (DCN-O), 7-66
passage (PP), 7-46
pop-up (PUP), 7-23
rally (RLY), 7-46
rearm, refuel, and resupply
(R³P), 7-70
refuel on the move (ROM),
7-70
release (RP), 7-46
special, 7-44
start (SP), 7-46
supply, Class I, 7-71
supply, Class II, 7-71
supply, Class III, 7-72
supply, Class III aviation, 7-
72
supply, Class IV, 7-72
supply, Class IX, 7-73
supply, Class V, 7-72
supply, Class VI, 7-73
supply, Class VII, 7-73
supply, Class VIII, 7-73
supply, Class X, 7-74
supply, general/multiple
classes, 7-71
target reference point
(TRP), 7-28
thorough decontamination
site/point (DCN-T), 7-67
traffic control post (TCP), 7-
70
trailer transfer point (TTP),
7-70
troops decontamination
site/point (DCN-T), 7-65
unit maintenance collection
(UMCP), 7-71
unspecified alternate
decontamination
site/point (DCN), 7-65
unspecified
decontamination
site/point (DCN), 7-65
way, 7-47
postal. *See* multifunctional
combat service support
public affairs. *See*
multifunctional combat
service support

R

railway, 5-47
reconnaissance, 5-48
light armored (LAR), 5-22
long range surveillance, 5-
22
marine (amphibious), 5-22

marine division, 5-22
marine force, 5-22
wheeled armored, 5-22
reconnaissance, cavalry, or
scouts, 5-21
recovery, 5-48
religious support (chaplain).
See multifunctional combat
service support
replacement holding unit
(RHU). *See* multifunctional
combat service support
riverine or floating, 5-48
rocket launcher, 6-11
antitank, 6-13
antitank heavy, 6-14
antitank light, 6-14
antitank medium, 6-14
multiple, 6-13
multiple heavy, 6-13
multiple light, 6-13
multiple medium, 6-13
single, 6-11
single heavy, 6-12
single light, 6-11
single medium, 6-11
rocket launchers, 5-17
multiple, 5-19
self-propelled multiple, 5-19
self-propelled single, 5-17
single, 5-17
towed multiple, 5-19
towed single, 5-19
truck mounted multiple, 5-
19
truck mounted single, 5-19
rotary wing, 5-9
air cavalry, 5-11
and fixed wing (composite),
5-11
antisubmarine warfare
(ASW), 5-11
attack, 5-11
command and control (C2),
5-11
medical evacuation
(MEDEVAC), 5-11
mine countermeasure
(MCM), 5-11
reconnaissance (Scout), 5-
11
search & rescue (SAR), 5-
11
unmanned aerial vehicle, 5-
13
utility, 5-11
utility heavy, 5-11

utility light, 5-11
 utility medium, 5-11

S

signal, 5-30
 area, 5-30
 communications
 contingency package (CCP), 5-30
 communications
 contingency package (CCP) light, 5-30
 enhanced position location reporting system (EPLRS) ground reference unit, 5-32
 light of sight radio relay, 5-32
 mobile subscriber equipment (MSE) large extension node (LEN), 5-32
 mobile subscriber equipment (MSE) node center (NC), 5-32
 mobile subscriber equipment (MSE) radio access unit (RAU), 5-32
 mobile subscriber equipment (MSE) small extension node (SEN), 5-32
 radio unit tactical satellite, 5-32
 radio unit teletype center, 5-32
 tri-service tactical communications AN/TTC-39D, 5-32
 tri-service tactical communications single shelter switch (SSS), 5-32
 ski, 5-48
 special equipment
 flame thrower, 6-41
 land mines, 6-41
 land mines claymore, 6-41
 land mines less than lethal, 6-41
 laser, 6-39
 NBC, 6-39
 smoke generator, 6-39
 Special Operations Forces (SOF), 5-49
 Army special forces, 5-51
 aviation, 5-49
 civil affairs, 5-53
 fixed wing, 5-49

fixed wing attack, 5-49
 fixed wing aviation
 psychological operations, 5-53
 fixed wing refuel, 5-49
 fixed wing utility, 5-49
 naval, 5-51
 psychological operations (PSYOP), 5-51
 Ranger, 5-51
 rotary wing, 5-49
 rotary wing attack, 5-51
 rotary wing combat search and rescue, 5-49
 rotary wing utility, 5-51
 sea-air-land team (SEAL), 5-51
 special attack submarine nuclear and radiological (SSNR), 5-51
 special boat, 5-51
 support, 5-53
 V/STOL, 5-49
 supply, 5-40
 Class I (subsistence), 5-40
 Class III (OL aviation), 5-40
 Class III (POL), 5-40
 Class IV (construction materials), 5-40
 Class IX (repair parts), 5-42
 Class V (ammunition), 5-40
 Class VII (major end items), 5-42
 Class VIII (medical), 5-42
 Class X (nonstandard items), 5-42
 clothing and equipment, 5-40
 laundry/bath, 5-42
 personal demand items, 5-40
 Quartermaster, 5-40
 supply trains, 5-40
 water, 5-42
 water purification, 5-42
 supply routes
 alternate (ASR), 7-75
 alternating traffic, 7-75
 main (MSR), 7-75
 one-way traffic, 7-75
 two-way traffic, 7-75
 surface shelter, 7-61
 surface-to-surface missile, 5-22
 strategic, 5-22
 tactical, 5-22
 survey, 5-19
 suspect, 4-3

T

tactical mission canalize, A-2
 tactical mission tasks
 block, A-2
 breach, A-2
 bypass, A-2
 clear, A-2
 contain, A-2
 counterattack, A-3
 counterattack by fire, A-3
 delay, A-3
 destroy, A-3
 disrupt, A-3
 fix, A-3
 follow and assume, A-4
 follow and support, A-4
 interdict, A-4
 isolate, A-4
 neutralize, A-4
 occupy, A-4
 passage of lines (rearward), A-5
 passage of lines, forward, A-4
 penetration, A-5
 relief in place (RIP), A-5
 retain, A-5
 retirement, A-5
 secure, A-5
 security, cover, A-6
 security, guard, A-6
 security, screen, A-5
 seize, A-6
 suppress, A-6
 turn, A-6
 withdraw, A-6
 withdraw under pressure, A-6
 tank, 6-3
 friendly M1A2 (Abrams)
 heavy, 6-3
 heavy, 6-3
 target acquisition, 5-19
 ANGLICO, 5-21
 flash (optical), 5-21
 radar, 5-21
 reconnaissance (COLT/FIST), 5-21
 sound, 5-19
 target acquisition tracked (COLT/FIST), 5-21
 targets
 circular, 7-42
 final protective fire (FPF), 7-42
 group, rectangular, 7-43
 group, regular, 7-43
 irregular shaped, 7-42

- linear, 7-41
 - linear smoke, 7-43
 - nuclear, 7-41
 - planned smoke, 7-43
 - point/single, 7-41
 - rectangular, 7-42
 - series, rectangular, 7-43
 - series, regular, 7-42
 - smoke, 7-44
 - task organizations
 - air assault infantry, D-7
 - air cavalry, D-7
 - air defense, D-6
 - airborne infantry, D-7
 - antitank, D-6
 - armor, D-6
 - armored calvary, D-6
 - assault/lift helicopters, D-7
 - attack helicopters, D-7
 - engineer, D-7
 - field artillery, D-7
 - infantry, D-7
 - light infantry, D-7
 - mechanized infantry, D-7
 - medium infantry, D-7
 - mountain infantry, D-7
 - reconnaissance/scout, D-7
 - theater missile defense (TMD), 5-7
 - theater/echelons above corps multifunctional combat service support
 - are support batttalion (ASB), 5-64
 - area support group (ASG), 5-64
 - Theater Army Area Command (TAACOM), 5-64
 - Theater Support Command (TSC), 5-64
 - towed, 5-48
 - transportation, 5-42
 - aerial port of debarkation/aerial port of embarkation (APOD/APOE), 5-44
 - movement control center (MCC), 5-42
 - railhead, 5-42
 - seaport of debarkation/seaport of embarkation (SPOD/SPOE), 5-44
- U**
- underground shelter, 7-61
 - unknown, 4-3
 - unmanned aerial vehicle (UAV), 5-13
 - utility vehicles
 - bus, 6-30
 - cargo or personnel carrier, 6-30
 - cross-country truck, 6-32
 - limited cross-country truck, 6-32
 - limited cross-country truck/amphibious, 6-32
 - semi (tractor trailer), 6-30
- V**
- vertical/short takeoff and landing (V/STOL), 5-13
- W**
- weapon system, 6-8

FM 1-02 (FM 101-5-1)
MCRP 5-12A
21 SEPTEMBER 2004

By Order of the Secretary of the Army:

PETER J. SCHOOMAKER
General, United States Army
Chief of Staff

Official:



JOEL B. HUDSON
Administrative Assistant to the
Secretary of the Army
0432103

By Direction of the Commandant of the Marine Corps:

EDWARD HANLON, JR.
Lieutenant General, United States Marine Corps
Commanding General
Marine Corps Combat Development Command

DISTRIBUTION:

Active Army, Army National Guard, and U.S. Army Reserve: To be distributed in accordance with the initial distribution number 110515, requirements for FM 1-02.

PIN: 082015-000

FM 1-02 (FM 101-5-1)
MCRP 5-12A
21 SEPTEMBER 2004

By Order of the Secretary of the Army:

PETER J. SCHOOMAKER
General, United States Army
Chief of Staff

Official:

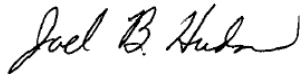

JOEL B. HUDSON
Administrative Assistant to the
Secretary of the Army

By Direction of the Commandant of the Marine Corps:



EDWARD HANLON, JR.
Lieutenant General, United States Marine Corps
Commanding General
Marine Corps Combat Development Command

DISTRIBUTION:

Active Army, Army National Guard, and US Army Reserve: To be distributed in accordance with the initial distribution number 110406, requirements for FM 1-02 (formerly FM 101-5-1).